

บริษัท นีโอ แบริ่ง ซัพพลาย จำกัด

1192/3 ซอย วัชรธรรมสาธิต 57 แขวงบางจาก เขตพระโขนง กทม. 10260

โทร. 02 185 4445 | Line @neobearing | www.neobearingsupply.com

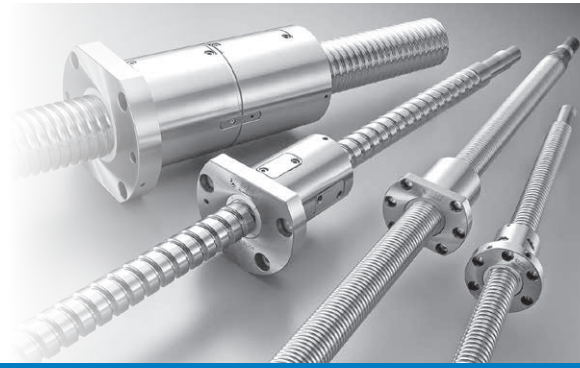

Ball screws

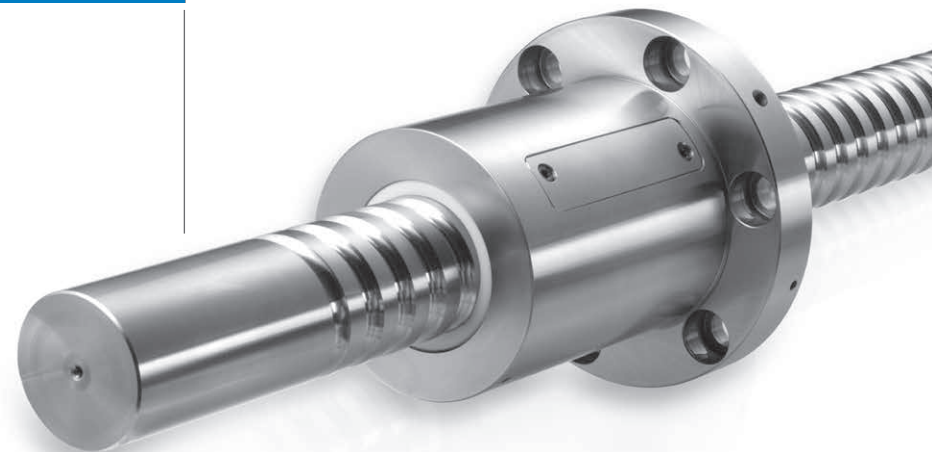

Features of PMI BallScrews

High reliability

PMI has accumulated many years experience in production managing. It covers the whole production sequence, from receiving the order, designing, material preparation, machining, heat treating, grinding, assembling, inspection, packaging and delivery. The systemized managing ensures high reliability of PMI BallScrews.

High accuracy

PMI BallScrews are machined, ground, assembled and Q.C. inspected under the constant temperature control (20°C) to ensure high precision of BallScrews. Fig.1 accuracy inspection certificate. The ground ball screw which accuracy grade is C5 or above, will attach an accuracy certificate of inspection.

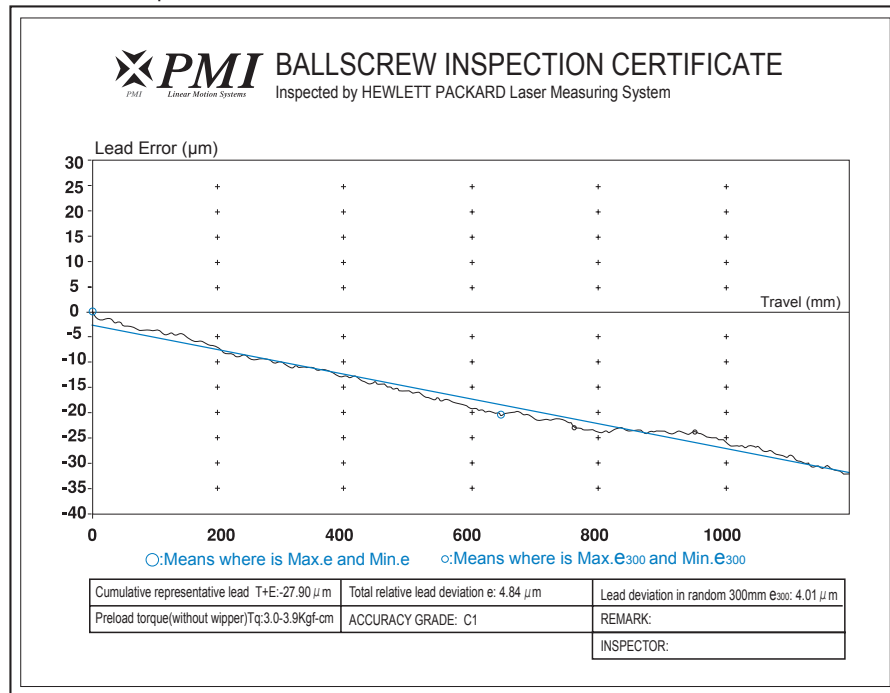

Fig.1 Accuracy inspection certificate.

Long durability

PMI BallScrews are Alloy steels, which are well quenching and tempering treated for good rigidity, along with suitable surface hardening to ensure long durability.

High working efficiency

Balls are rotating inside the BallScrew nut to offer high working efficiency. Comparing with the traditional ACME screws, which work by friction sliding between the nut and screw, the BallScrews needs only 1/3 of driving torque. It is easy to transmit linear motion into rotation motion.

No backlash and with high rigidity

The Gothic profile is applied by PMI BallScrews. It offers best contact between balls and the grooves. If suitable preload is exerted on BallScrew hence to eliminate clearance between the ball nut and screw and to reduce elastic deformation, the ballScrew shall get much better rigidity and accuracy.

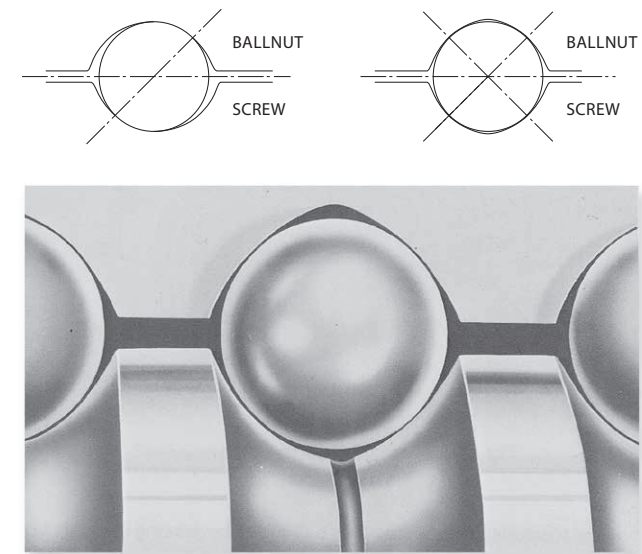

Fig.2 Gothic arch thread

Lead Accuracy

PMI's precision ground Ballscrews are controlled in accordance with JIS B 1192. The permissible values and each part of definitions are shown below.

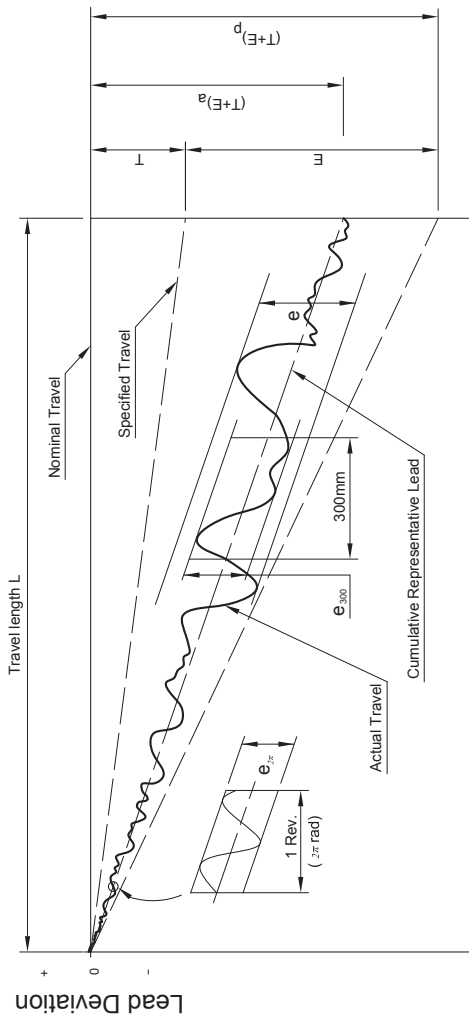

Fig.3 Technical Terms Concerning the Lead

Table 1 Terms

T+E	Cumulative representative lead. A straight line representing the tendency of the cumulative actual lead. This is obtained by least square method and measured by laser system.
P	Permissible value.
a	Actual value.
T	Specified travel. This value is determined by customer and maker as it depends on different application requirements.
E	Accumulated reference lead deviation. This is allowable deviation of specified travel. It is decided by both of the accuracy grade and effective thread length.
e	Total relative lead variation Maximum width of variation over the travel length.
e₃₀₀	Lead deviation in random 300 mm.
e_{2π}	Lead deviation in random 1 revolution 2π rad.

Table 2 Accumulated reference lead deviation ($\pm E$) and total relative variation (e)

Unit: μm

Effective thread length (mm)	GRADE		C0		C1		C2		C3		C4		C5	
	OVER	UPTO	E	e	E	e	E	e	E	e	E	e	E	e
-	315	4	3.5	6	5	8	7	12	8	12	12	23	18	
315	400	5	3.5	7	5	9	7	13	10	14	12	25	20	
400	500	6	4	8	5	10	7	15	10	16	12	27	20	
500	630	6	4	9	6	11	8	16	12	18	14	30	23	
630	800	7	5	10	7	13	9	18	13	20	14	35	25	
800	1000	8	6	11	8	15	10	21	15	22	16	40	27	
1000	1250	9	6	13	9	18	11	24	16	25	18	46	30	
1250	1600	11	7	15	10	21	13	29	18	29	20	54	35	
1600	2000	-	-	18	11	25	15	35	21	35	22	65	40	
2000	2500	-	-	22	13	30	18	41	24	41	25	77	46	
2500	3150	-	-	26	15	36	21	50	29	50	29	93	54	
3150	4000	-	-	32	18	44	25	60	35	62	35	115	65	
4000	5000	-	-	-	-	52	30	72	41	76	41	140	77	
5000	6300	-	-	-	-	65	36	90	50	95	50	170	93	
6300	8000	-	-	-	-	-	-	110	62	120	62	210	115	
8000	10000	-	-	-	-	-	-	137	75	157	75	260	140	

Table 3 Accuracy grade

Variation in random 300mm (e_{300}) and wobble ($e_{2\pi}$)

e_{300}

Unit: μm

GRADE	C0	C1	C2	C3	C4	C5	C6	C7	C10
JIS	3.5	5	-	8	-	18	-	50	210
ISO	3.5	6	-	12	-	23	-	52	210
DIN	-	6	-	12	-	23	-	52	210
PMI	3.5	5	7	8	12	18	25	50	210

$e_{2\pi}$

Unit: μm

GRADE	C0	C1	C2	C3	C4	C5
JIS	3	4	-	6	-	8
ISO	3	4	-	6	-	8
DIN	-	4	-	6	-	8
PMI	3	4	4	6	8	8

Table 4 Accuracy grades of ball screw and their application

Application	Name of axis	Accuracy grade									
		C0	C1	C2	C3	C4	C5	C6	C7	C10	
NC Machine tools	Lathe	X	•	•	•	•	•	•			
		Z				•	•	•			
	Machining center	X,Y		•	•	•	•	•			
		Z			•	•	•	•			
	Drilling machine	X,Y				•	•	•			
		Z						•	•	•	
	Milling machine Boring machine	X,Y		•	•	•	•	•			
		Z			•	•	•	•			
	Jig boring machine	X,Y	•	•							
		Z	•	•							
	Grinder	X,Y	•	•	•						
		Z		•	•	•					
	Electric discharge machine	X,Y		•	•	•					
		Z			•	•	•	•			
	Wire cutting Electric discharge machine	X,Y		•	•	•					
		Z		•	•	•	•				
	Punch press	X,Y				•	•	•			
	Laser cutting machine	X,Y				•	•	•			
		Z				•	•	•			
	Woodworking machine						•	•	•	•	
General industrial machines Machines for specific use					•	•	•	•	•	•	

Application	Name of axis	Accuracy grade									
		C0	C1	C2	C3	C4	C5	C6	C7	C10	
Industrial robots	Cartesian type	Assembly			•	•	•	•	•	•	
		other purposes						•	•	•	•
	Articulate type	Assembly				•	•	•	•	•	
		other purposes						•	•	•	
	SCARA type				•	•	•	•	•		
Semiconductor/ associated industrial	Lithographic machine	•	•								
	Chemical processing equipment				•	•	•	•	•	•	
	Wire bonder		•	•							
	Prober	•	•	•							
	Printed circuit board drilling machine Electric component mounted device		•	•	•	•	•				
Three-dimensional coordinate measuring machine	•	•	•								
Office machine							•	•	•	•	
Image processing machine	•	•									
Plastic injection molding machine									•	•	
Steel mills equipment									•	•	
Nuclear power	Fuel rod control				•	•	•	•	•		
	Mechanical snubber								•	•	
Aircraft				•	•	•					

Preloading Torque

The preloading torque of the Ballscrew is controlled in accordance with JIS B 1192.

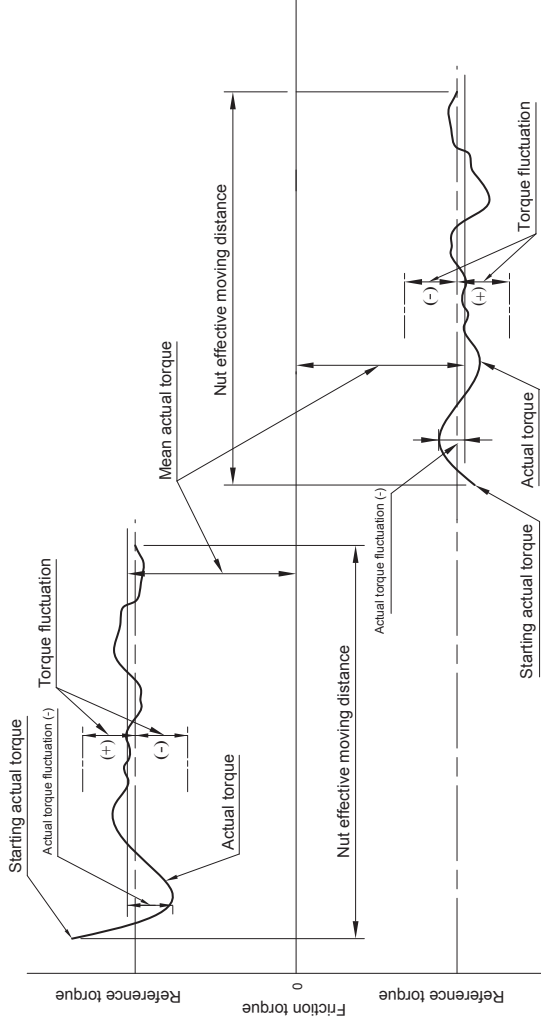

Fig.4 Technical terms concerning preload

Preload	The purpose of preload is to eliminate axial play and increase rigidity of Ballscrew. Reference to A1-12 Ballscrew's preload and effect.
Preload torque	Torque needed to continuously turn a Ballscrew with preload with no other load applied to it.
Reference torque	Preload torque set as a goal.
Torque fluctuation	Fluctuation from a goal value of the preload torque. Defined as positive or negative in respect to the reference torque.
Rating of torque fluctuation	Rating on reference torque and torque fluctuation.
Actual torque	Preloaded dynamic torque measured by using an actual value of Ballscrew.
Mean actual torque	In the effective thread length, the net reciprocate to measure the maximum actual torque and minimum actual torque are doing count mean.
Actual torque fluctuation	In the effective thread length, the net reciprocate to measure the maximum fluctuant value.
Rating of Actual torque fluctuation	Rating on mean actual torque and actual torque fluctuation.

Table 5 Allowable range of preload torque

Reference torque (kgf.cm)		Effective Thread Length (mm)										
		up to and incl. 4000								over 4000 up to and incl. 10000.		
		Slenderness ratio: up to and incl. 40				Slenderness ratio: over 40 up to and incl. 60						
		Accuracy grade				Accuracy grade				Accuracy grade		
OVER	OR LESS	C0	C1	C3	C5	C0	C1	C3	C5	C1	C3	C5
2	4	±30%	±35%	±40%	±50%	±40%	±40%	±50%	±60%	-	-	-
4	6	±25%	±30%	±35%	±40%	±35%	±35%	±40%	±45%	-	-	-
6	10	±20%	±25%	±30%	±35%	±30%	±30%	±35%	±40%	-	±40%	±45%
10	25	±15%	±20%	±25%	±30%	±25%	±25%	±30%	±35%	-	±35%	±40%
25	63	±10%	±15%	±20%	±25%	±20%	±20%	±25%	±30%	-	±30%	±35%
63	100	-	±15%	±15%	±20%	-	-	±20%	±25%	-	±25%	±30%

Note: Slenderness Ratio: Effective Thread Length/Screw Nominal O.D.

Reference torque

$$T_p = 0.05 (\tan \beta)^{-0.5} \times \frac{F_{ao} \times l}{2\pi} \dots\dots\dots(1)$$

Here

T_p Reference torque (kgf.cm) l Lead (cm)
 F_{ao} Preload (kgf) β Lead angle

Tolerances on Various Areas of PMI Ballscrew

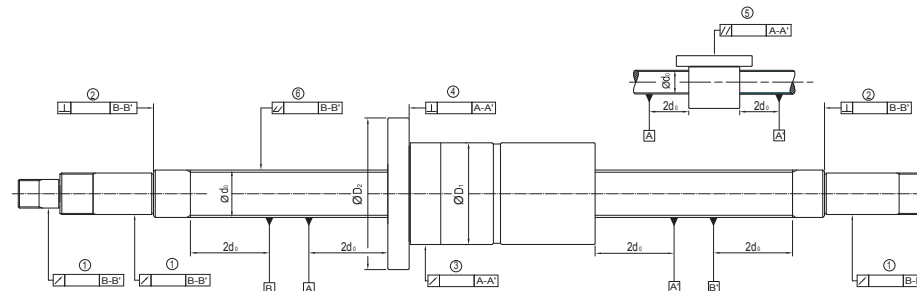

Fig.5

Those on above are samples of accuracy of tolerance on various areas of PMI Ballscrew.

⊥ : Perpendicularity ↗ : Radial runout // : Parallel ▽ : Reference

Accuracy on various areas of PMI Ballscrew has to measure items:

1. Radial run-out of the circumference of the screw shaft supported portion in respect to the B-B' line.
2. Perpendicularity of the screw shaft supported portion end face to the B-B' line.
3. Radial run-out of the nut circumference in respect to the A-A' line.
4. Perpendicularity of the flange mounting surface to the A-A' line.
5. Parallelism between the nut circumference to the A-A' line.
6. Overall radial run-out to the A-A' line.

Note: The mounting surface of the Ballscrew is finished to the accuracy specified in JIS B 1192:1997

Standard tolerance of accuracy measuring of ballscrew

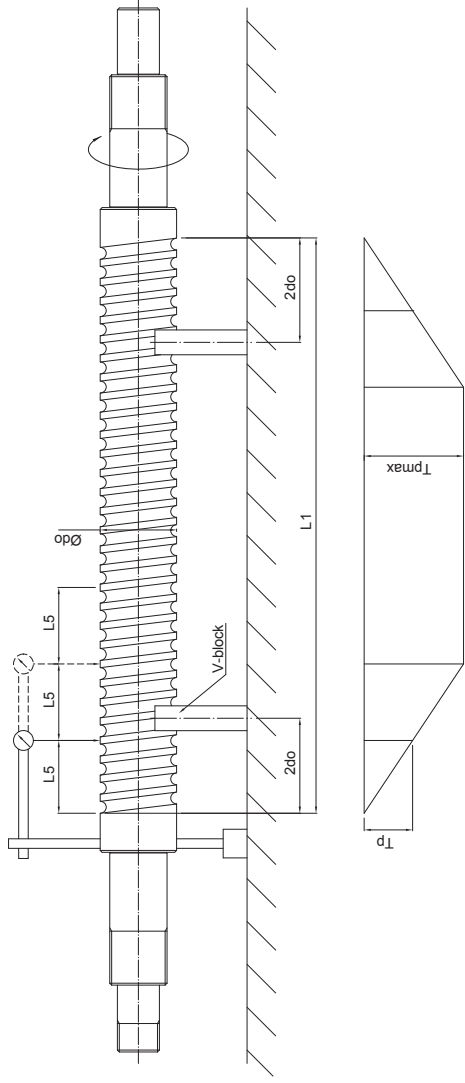

Table 6 Total runout in radial direction of outside diameter of screw shaft threaded part in respect to measuring basic length (measuring basic length is according to DIN 69051 and JIS B1192)

Normal diameter d_o (mm)	Measuring basic length L_s	PMI's Grade ($L_1 \geq 4L_s$)												
		C0	C1	C2	C3	C4	C5	C6	C7	C10				
above	up to and incl.	-	-	-	-	-	-	-	-	-	-	-	-	-
6	80	-	-	-	-	-	-	-	-	-	-	-	-	-
12	25	-	-	-	-	-	-	-	-	-	-	-	-	-
25	50	20	20	20	23	25	28	32	40	80	-	-	-	-
50	100	20	20	20	23	25	28	32	40	80	-	-	-	-
100	200	20	20	20	23	25	28	32	40	80	-	-	-	-
1250	-	-	-	-	-	-	-	-	-	-	-	-	-	-
Slenderness ratio L_1/d_o (mm)		PMI's Grade ($L_1 \geq 4L_s$)												
above	up to and incl.	C0	C1	C2	C3	C4	C5	C6	C7	C10	-	-	-	-
-	40	40	40	40	45	50	60	64	80	160	-	-	-	-
40	60	60	60	60	70	75	85	96	120	240	-	-	-	-
60	80	100	100	100	115	125	140	160	200	400	-	-	-	-
80	100	160	160	160	180	200	220	256	320	640	-	-	-	-

Unit: μm

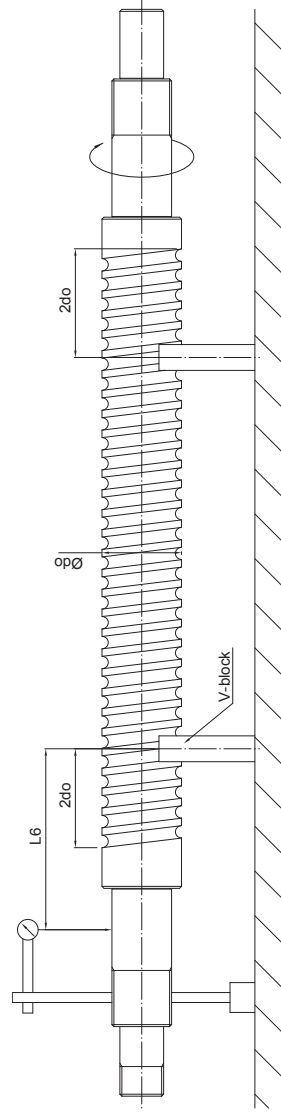

Table 7 Circumferential runout in radial direction of outside diameter of mounting part of parts in respect to threaded part axial line of screw shaft (measuring basic length is according to DIN 69051 and JIS B1192)

Normal diameter d_o (mm)	Measuring basic length L_r	PMI's Grade ($L_6 < L_r$)												
		C0	C1	C2	C3	C4	C5	C6	C7	C10				
above	up to and incl.	-	-	-	-	-	-	-	-	-	-	-	-	-
6	20	6	8	10	11	12	16	20	40	63	-	-	-	-
20	50	8	10	12	14	16	20	25	50	80	-	-	-	-
50	125	10	12	16	18	20	26	32	63	100	-	-	-	-
125	200	10	12	16	18	20	26	32	63	100	-	-	-	-
200	315	-	-	-	20	25	32	40	80	125	-	-	-	-

Unit: μm

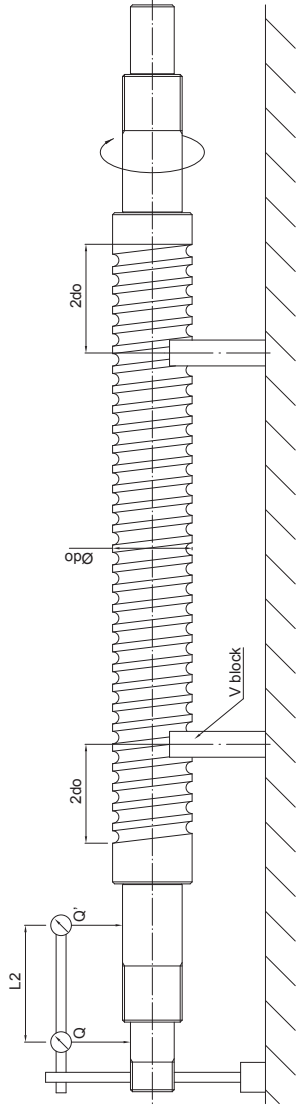

Table 8 Perpendicularity on supporting-part end face in respect to the threaded part axial line of screw shaft (measuring basic length is according to DIN 69051 and JIS B1192)(Difference of maximum value within Q and Q')

Unit: μm

Normal diameter d_o (mm)	Measuring basic length L_2	PMI's Grade ($L_2 \leq L_T$)												
		C0	C1	C2	C3	C4	C5	C6	C7	C10				
above	up to and incl.	-	-	-	-	-	-	-	-	-	-	-	-	-
6	20	4	5	5	6	6	7	8	8	12	16			
20	50	5	6	6	7	8	9	10	10	16	20			
50	125	6	7	8	9	10	11	12	12	20	25			
125	200	-	-	-	10	12	14	16	16	25	32			

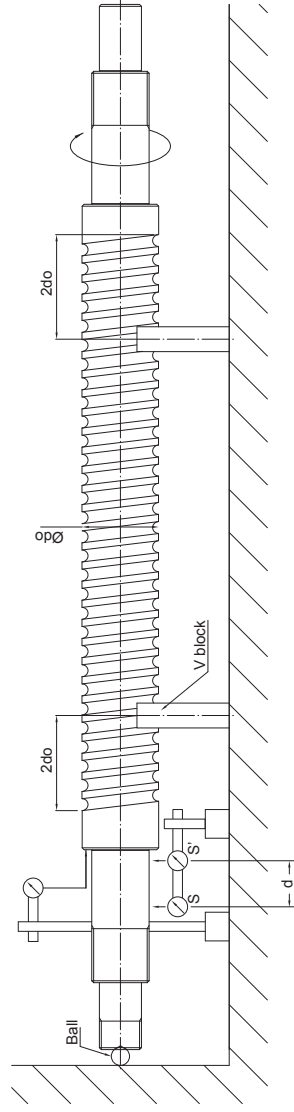

Table 9 Perpendicularity on supporting-part end face in respect to the threaded part axial line of screw shaft (measuring basic length is according to DIN 69051 and JIS B1192) (the value of deflection supports two ends' deflection of difference between S and S')

Unit: μm

Normal diameter d_o (mm)	up to and incl.	PMI's Grade												
		C0	C1	C2	C3	C4	C5	C6	C7	C10				
above	up to and incl.	-	-	-	-	-	-	-	-	-	-	-	-	-
6	63	3	3	3	4	4	5	5	6	6	10			
63	125	3	4	4	5	5	6	6	8	8	12			
125	200	-	-	-	6	6	8	8	10	16				

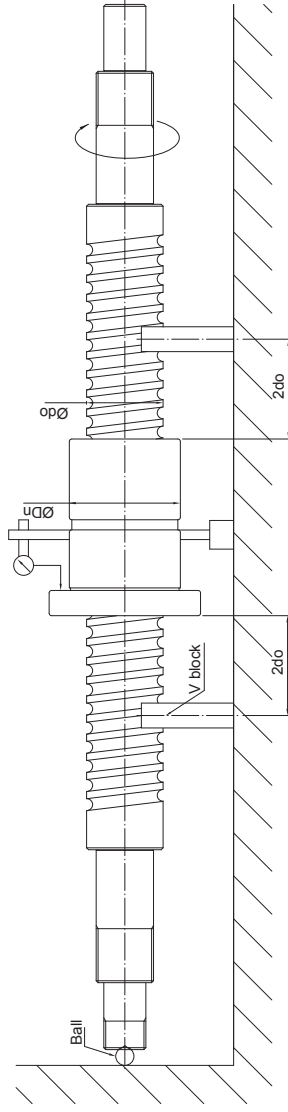

Table 10 Perpendicularity on mounting face of flang of nut (measuring basic length is according to DIN 69051 and JIS B1192)

Outside diameter of nut D_n	PMI's Grade										Unit: μm
	C0	C1	C2	C3	C4	C5	C6	C7	C10		
above up to and incl. 20	5	6	7	8	9	10	12	14	14	-	-
20 32	5	6	7	8	9	10	12	12	14	-	-
32 50	6	7	8	8	10	11	15	18	-	-	-
50 80	7	8	9	10	12	13	16	18	-	-	-
80 125	7	9	10	12	14	15	18	20	-	-	-
125 160	8	10	11	13	15	17	19	20	-	-	-
160 200	-	11	12	14	16	18	22	25	-	-	-
200 250	-	12	14	15	18	20	25	30	-	-	-

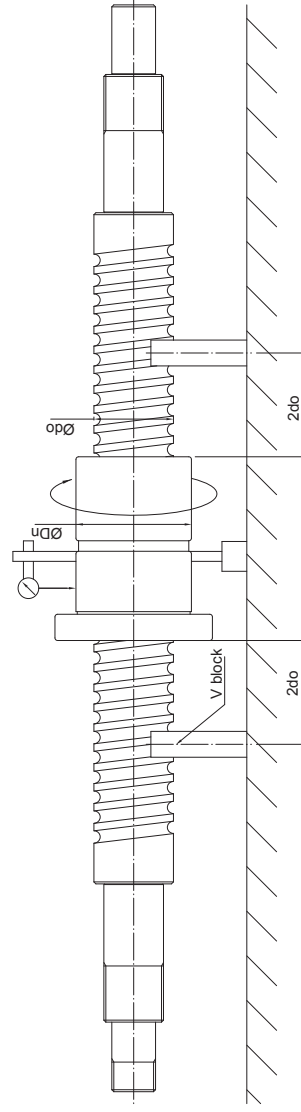

Table 11 Circumferential runout in radial direction on outer peripheral face of nut (measuring basic length is according to DIN 69051 and JIS B1192)

Outside diameter of nut D_n	PMI's Grade										Unit: μm
	C0	C1	C2	C3	C4	C5	C6	C7	C10		
above up to and incl. 20	5	6	7	9	10	12	16	20	-	-	-
20 32	6	7	8	10	11	12	16	20	-	-	-
32 50	7	8	10	12	14	15	20	25	-	-	-
50 80	8	10	12	15	17	19	25	30	-	-	-
80 125	9	12	16	20	21	22	25	40	-	-	-
125 160	10	13	17	22	25	28	32	40	-	-	-
160 200	-	16	20	22	25	28	32	40	-	-	-
200 250	-	17	20	22	25	28	32	40	-	-	-

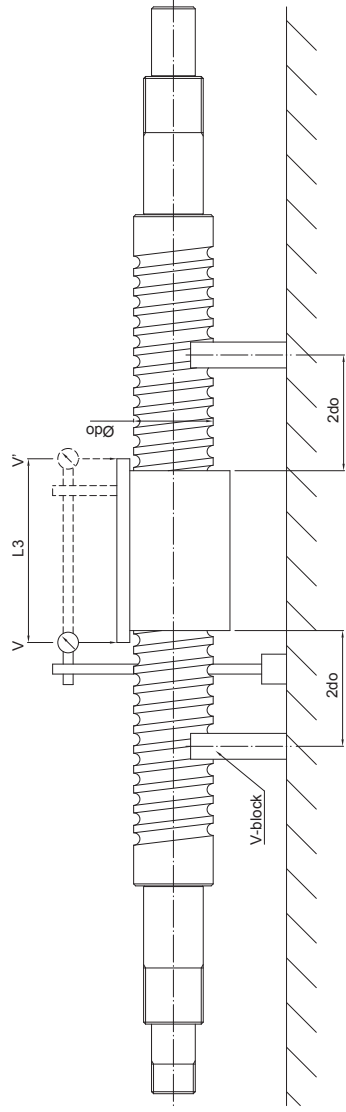

Table 12 Parallelism on outer peripheral face of nut (V-V)/(measuring basic length is according to DIN 69051 and JIS B1192)

Measuring basic length L_3 above up to and incl	PMI's Grade										Unit: μm
	C0	C1	C2	C3	C4	C5	C6	C7	C10		
-	5	6	7	8	9	10	14	17	-	-	
50	6	7	8	10	11	12	15	17	-	-	
100	-	10	11	13	15	17	24	30	-	-	

Design of Screw Shaft

Production Limit Length of Screw Shaft

Production limit length of precision ground Ballscrew:

When screw shaft O.D. is 4 mm, Limit length of Ballscrew is 150 mm.

When screw shaft O.D. is 120 mm, Limit length of Ballscrew is 10000 mm.

Note: Please contact with our sales people in case a special type is required.

Production limit length of rolled Ballscrew:

When screw shaft O.D. is 8 mm, Limit length of Ballscrew is 1000 mm.

When screw shaft O.D. is 80 mm, Limit length of Ballscrew is 6000 mm.

Note: Please contact with our sales people in case a special type is required.



Mounting Method

The permissible axial load and permissible rotational speed vary with the screw-shaft mounting method used, so the mounting method should be determined in accordance with the operating conditions.

Fig.6~8 illustrate a typical method for mounting a screw shaft.

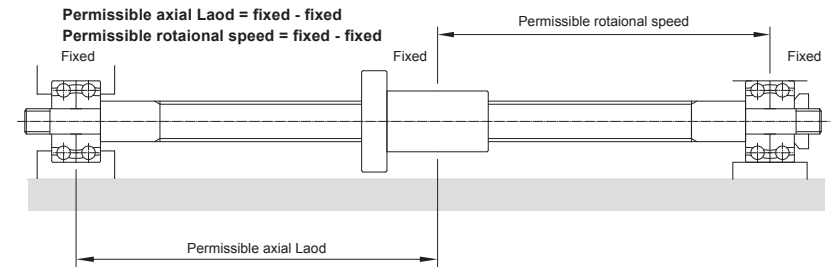

Fig.6 Mount method : fixed-fixed

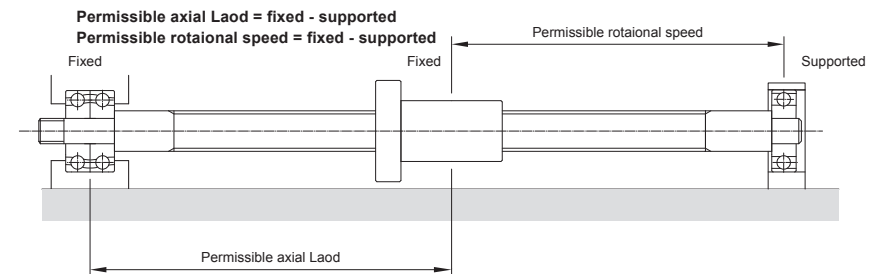

Fig.7 Mount method : fixed-supported

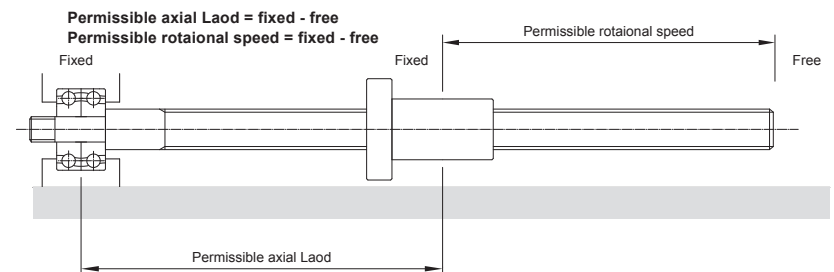

Fig.8 Mount method : fixed-free

Permissible Axial Load

Buckling load

The Ballscrew to be used should not buckle under the maximum compressive load applied in its axial direction. The buckling load can be calculated by using equation (2).

$$P = \alpha \frac{\pi^2 NEI}{L^2} = m \frac{dr^4}{L^2} \times 10^3 \quad (kgf) \dots\dots\dots(2)$$

Here:

- α Safety factor ($\alpha=0.5$)
- E Young's modulus ($E=2.1 \times 10^4 \text{ kgf/mm}^2$)
- I Minimum geometrical moment of inertia of the screw shaft cross section ($I=\pi dr^4 / 64 \text{ mm}^4$)
- dr Screw shaft thread minor diameter (mm)
- L Distance between mounting positions (mm)
- m, N Coefficient depending on the mounting method

supported-supported	$m=5.1$	($N=1$)
fixed-supported	$m=10.2$	($N=2$)
fixed-fixed	$m=20.3$	($N=4$)
fixed-free	$m=1.3$	($N=1/4$)

Permissible tensile-compressive load of the screw shaft

Where the axial load is exerted on the Ballscrew, the screw shaft to be used should be determined in consideration of the permissible tensile-compressive load that can exert yielding stress on the screw shaft.

The permissible tensile-compressive load can be calculated using equation (3).

- Permissible tensile-compressive load of yield stress of screw shaft

$$P = \sigma \cdot A = \sigma \cdot \pi \cdot dr^2 / 4 \dots\dots\dots(3)$$

Here:

- σ Permissible tensile-compressive stress (147 MPa)
- A Cross section area of root diameter of screw shaft (mm^2)
- dr Screw-shaft thread minor diameter (mm)

- Permissible Load of contact point of ball groove

The maximal axial load must be less than the basic static rate load of the ball screw shaft. For more details please see A1-56, Permissible Load on Thread Grooves.

Fig. Value shown (outer diameter of screw shaft-lead)

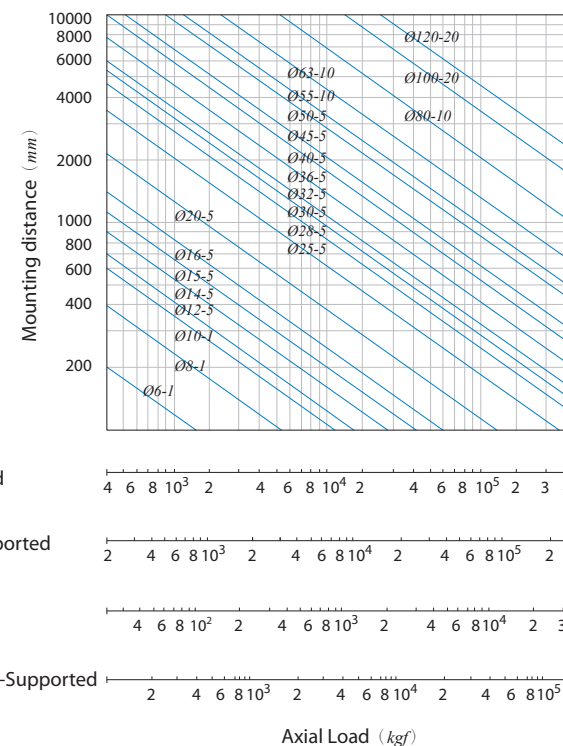

Fig.9 Permissible Axial Load

Permissible Rotational Speed

Critical rotation speed

When the rotation speed of driving motor coincides with the natural frequency of feed system (mainly the ballscrew), the resonance of vibration shall be triggered. This rotation speed is then called critical rotation speed. It shall make bad quality machining, since there is wave shape surface on the workpiece. It may also cause damage of machine. Hence it is very important to prevent the resonance of vibration from happening. We choose 80% of critical rotation speed as allowable speed. It is shown as formula (4).

It may be required to have additional supports in between the ends bearing supports to make the natural frequency of Ballscrew to be higher and hence to raise the allowable rotation speed.

$$n = \alpha \times \frac{60\lambda^2}{2\pi L^2} \sqrt{\frac{EIg}{\gamma A}} = f \frac{dr}{L^2} \times 10^7 \text{ (rpm)} \dots\dots\dots(4)$$

Here:

- n* Permissible rational speed (rpm)
- α* Safety factor (α=0.8)
- E* Young's modulus ($E=2.1 \times 10^4 \text{ kgf/mm}^2$)
- I* Minimum geometrical moment of inertia of the screw-shaft cross section ($I=\pi dr^4/64 \text{ mm}^4$)
- dr* Screw-shaft thread minor diameter (mm)
- A* Screw shaft cross-sectional area ($A=\pi dr^2/4 \text{ mm}^2$)
- L* Distance between mounting positions (mm)
- g* Gravitation acceleration ($g=9.8 \times 10^3 \text{ mm/s}^2$)
- γ* Specific gravity ($\gamma=7.8 \times 10^6 \text{ kgf/mm}^3$)
- f, λ* Coefficient depending on the mounting method
 - supported-supported $f=9.7 \quad (\lambda=\pi)$
 - fixed-supported $f=15.1 \quad (\lambda=3.927)$
 - fixed-fixed $f=21.9 \quad (\lambda=4.730)$
 - fixed-free $f=3.4 \quad (\lambda=1.875)$

dm.n Value of Ballscrew

dm is the BCD (ball circle diameter) of screw shaft, and *n* is the maximum rotation speed. The *dm.n* value relates and affects the noise, temperature raise, working life, balls circulation of the ballscrew. In general cases, the *dm.n* value is limited as follows:

Rolled ball screw	Allowable <i>dm.n</i> value	Criterion of permissible rotational speed (min ⁻¹)
Standard specifiction(normal lead)	≤50000	1500~2000
High-speed specifiction(large lead)	≤70000	2000~2500

Product Specification		Allowable <i>dm.n</i> value		maximum of turning number (standard) [min ⁻¹]
		standard	High-speed	
Ground Ballscrew	Inner circulation	≤70000		2000
	End Deflector	≤220000		3000
	Tube type	≤80000		2500
	E-type circuit	≤130000, ≤140000 ¹		3000
	Heavy load	≤130000	≤160000 ²	3000
	Heavy load series of end deflector		≤120000	2500
	Cap series circuit	≤120000		2500

Note: 1.The *dm.n* value can be reach 130000 in normal case. For some special cases, for example in a fixed ends case, the *dm.n* value can be as 140000.

2.As lead are 10mm, 12mm, 14mm and 16mm, the *dm.n* value ≤ 120000. As lead are 20mm and 25mm, the *dm.n* value ≤ 160000.

3.These *dm.n* values are for reference only. In fact, the *dm.n* value shall be decided by the ways of end supporting and the distance between them.

4.Please contact with our sales people in case a very high *dm.n* value is required.

With better manufacturing technology currently, the *dm.n* value is no longer limited as above. It is even higher than 100,000.

Fig. Value shown (outer diameter of screw shaft-lead)

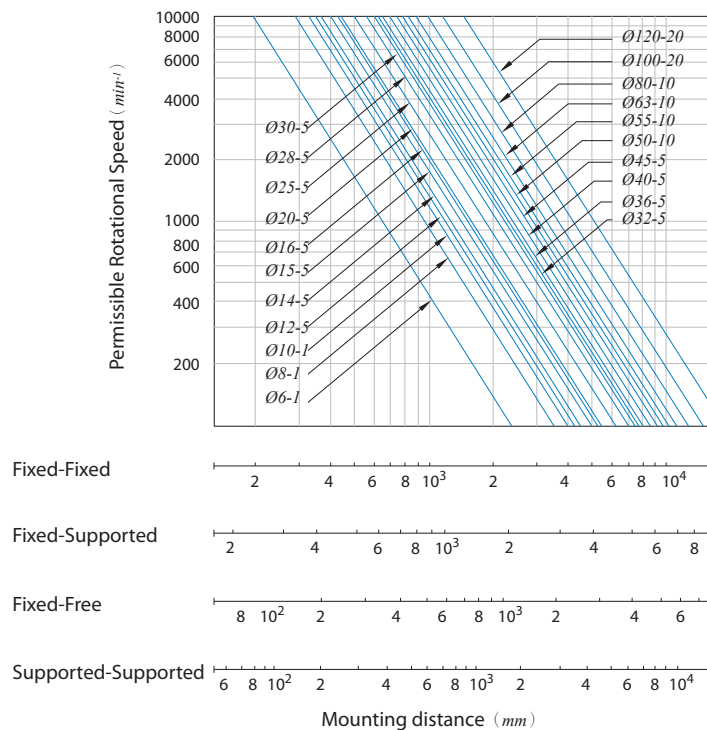

Fig.10 Permissible Rotational Speed

Notes on Screw Shaft

Through end thread

For the Ballscrews with internal ball circulation Ballnut, it is required to have at least one end with complete thread to the end of Ballscrew for Ballnut assembly to screw shaft. If it is impossible for through end thread, it is required to have at least one end with complete thread and the journal area is with diameter to be 0.2mm smaller than the diameter of thread root area.

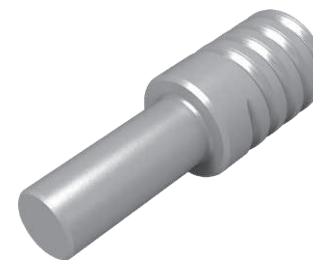

Fig.11 Incomplete thread

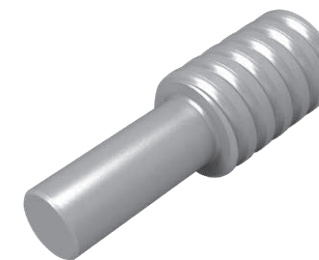

Fig.12 Through end thread

Machine design for the area of Ballnut and ends area of Ballscrew

It is very important to check if there is enough space for assembly of Ballscrew onto the machine during machine design. In some cases, there is not enough space for assembly and the Ballnut has to be disassembled from the screw shaft for easier work. It may cause problems, such as the balls falling out from Ballnut, worse accuracy of squareness and roundout of Ballnut, change of preload and damage to external ball circulating tubes. In some more serious cases, the ballscrew may be damaged and not to be used. Please contact with our people if said above disassembling is required.

Not effective hardened area

The threads on screw shaft are hardened by induction hardening. It shall cause about 15mm at both ends of thread area are not hard enough. It is required to pay attention during machine design for the effective thread length of travel.

Extra support unit for long ballscrew

For a long ballscrew, the bending due to self weight might happen. It may cause radial direction load to ballscrew. The radial direction vibration during rotation might also be more serious. To prevent these problems from happening, it may be required to have extra supports for ballscrew in between the existing supports at both ends. There are two types of supports; one is movable to move along the Ballnut. The other one is fixed type; it is located in a fixed position. The Table must be designed not to hit with this support during moving.

Fixed-Fixed

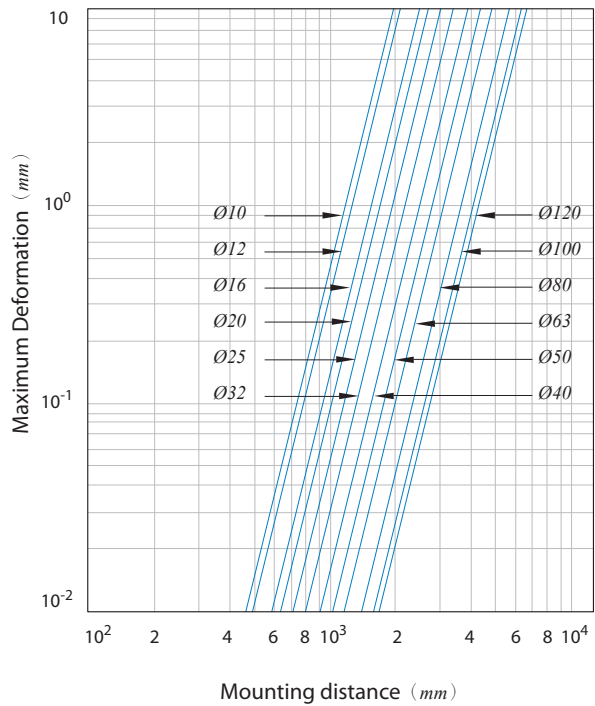
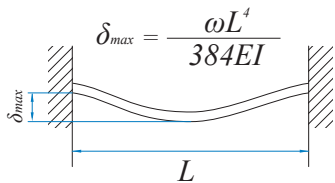

Fig.13 Maximun deformation for fixed-fixed

Fixed-Supported

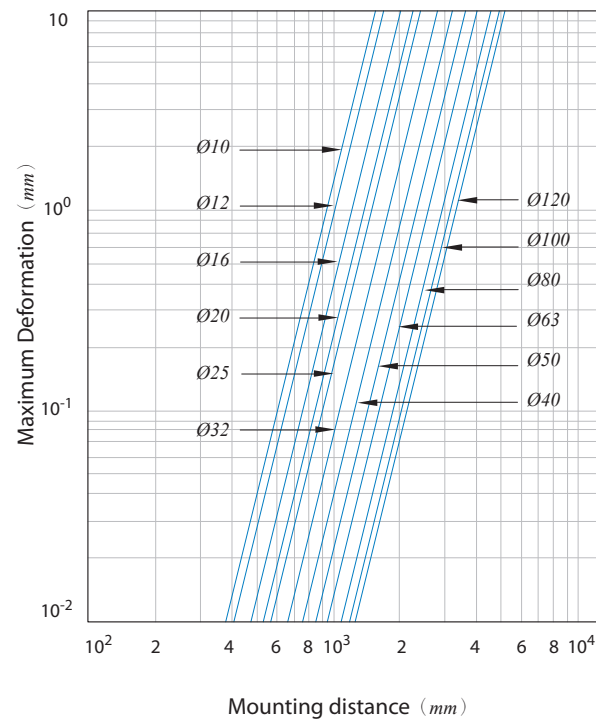
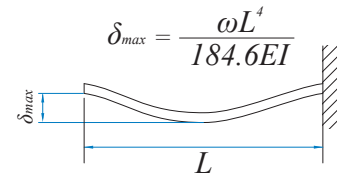

Fig.14 Maximun deformation for fixed-supported

Selecting the Type of Nut

Type

Selecting the type of Nut, please consider the accuracy; dimension (The length of Nut; internal diameter; external diameter), preload and the date of delivery.

Circulation

External ball circulation

Advantages:

- Lower noise due to longer ball circulation paths
- Offers smoother ball running.
- Offers better solution and quality for long lead or large diameter ballscrews.

Internal ball circulation

Advantages:

- Good for limited space of machine.
- Better structure for small lead or small diameter ballscrews.

Effective turns

Selecting effective turns have to consider required capability; life and rigidity. Refer to the **Table 13**

Flange

PMI have three standard type (A type, B type and C type) Please make selection by area space for nut installation. PMI can also make special flange as per customers' requests.

Oil hole

Standard nuts have oil hole. Please dimension in the diagram to manufacture.

Table 13 The character of effective turns

Character	External ball circulation	Internal ball circulation
Motion	1.5circuit ×2row, 1.5circuit ×3row, 2.5circuit ×1row	1circuit ×3row, 1circuit ×4row
Rigidity	2.5circuit ×2row, 2.5circuit ×3row	1circuit ×6row

Calculating the Axial Load

Horizontal reciprocating moving mechanism

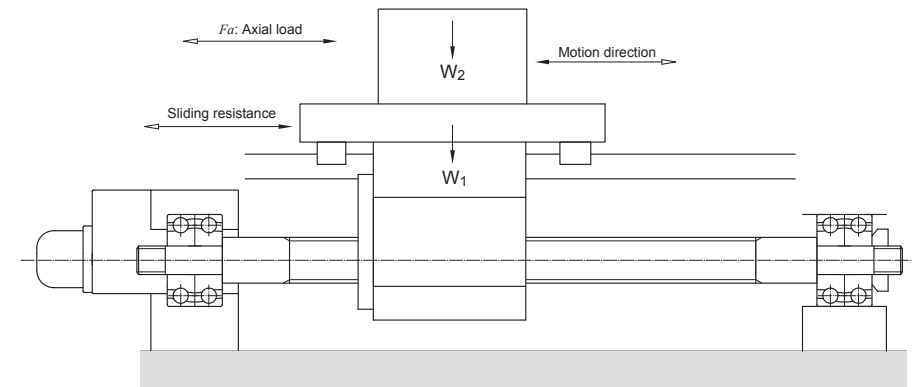

Fig.15 Horizontal reciprocating moving mechanism

For reciprocal operation to move work horizontally (back and forth) in an conveyance system, the axial load (F_a) can be gotten using the following equations:

$$\text{Acceleration (leftward)} \quad Fa_1 = \mu \times mg + f + ma \quad \dots\dots\dots(5)$$

$$\text{Constant speed (leftward)} \quad Fa_2 = \mu \times mg + f \quad \dots\dots\dots(6)$$

$$\text{Deceleration (leftward)} \quad Fa_3 = \mu \times mg + f - ma \quad \dots\dots\dots(7)$$

$$\text{Acceleration (rightward)} \quad Fa_4 = -\mu \times mg - f + ma \quad \dots\dots\dots(8)$$

$$\text{Constant speed (rightward)} \quad Fa_5 = -\mu \times mg - f \quad \dots\dots\dots(9)$$

$$\text{Deceleration (rightward)} \quad Fa_6 = -\mu \times mg - f + ma \quad \dots\dots\dots(10)$$

Here:

a Acceleration

$$a = \frac{V_{\max}}{t_a} \quad \begin{matrix} V_{\max} & \text{Rapid feed speed} \\ t_a & \text{time} \end{matrix}$$

m Total weight (table weight + work piece weight)

μ Friction coefficient of sliding surface

f Non-load resistance

Vertical Reciprocating Moving Mechanism

For reciprocal operation to move work vertically (up and down) in an conveyance system, the axial load (F_a) can be gotten using the following equations:

Acceleration (upward) $F_{a1} = mg + f + ma$ (11)

Constant speed (upward) $F_{a2} = mg + f$ (12)

Deceleration (upward) $F_{a3} = mg + f - ma$ (13)

Acceleration (downward) $F_{a4} = mg - f - ma$ (14)

Constant speed (downward) $F_{a5} = mg - f$ (15)

Deceleration (downward) $F_{a6} = mg - f + ma$ (16)

Here:

a Acceleration

$$a = \frac{V_{max}}{t_a} \quad \begin{matrix} V_{max} & \text{Rapid feed speed} \\ t_a & \text{time} \end{matrix}$$

m Total weight(table weight + work piece weight)

μ Friction coefficient of sliding surface

f Non-load resistance

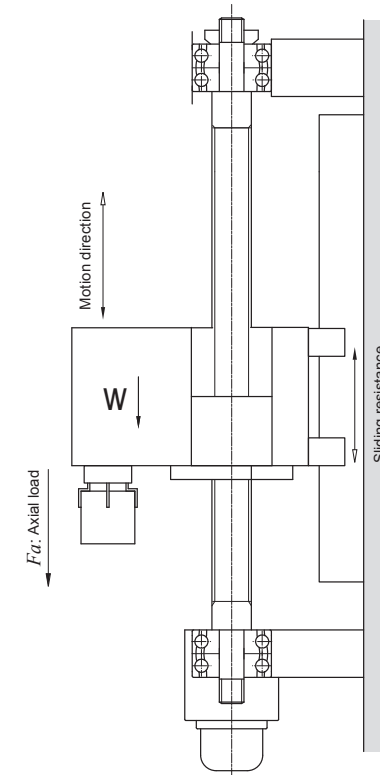

Fig.16 Vertical reciprocating moving mechanism

Notes on Ball Nut Design

Abnormal load: (torsional load or radial load)

When Ballscrew takes only axial load, the best performance of it shall be found; the balls on the groove in between the Ballnut and screw shaft shall evenly take the load and rotate smoothly. In case there is torsional load or radial load on Ballnut, this kind load shall be taken unevenly by some balls only. It shall badly affect Ballscrew performance and even shorten ballscrew life. It is recommended to pay more attention to the mechanism design and Ballscrew assembly.

Rigidity

Axial Rigidity

"Lost Motion" shall happen due to weakness of rigidity of screw shaft and mating components of it. In order to get good positioning accuracy, it is necessary to consider axial and torsional rigidity of screw shaft and mating components of it.

Axial Rigidity of the Feed-Screw System

Let the axial rigidity of a feed-screw system be K . Then, the elastic displacement in the axial direction can be obtained using equation (17).

$$\delta = \frac{Fa}{K_T} \dots\dots\dots(17)$$

$$\frac{1}{K_T} = \frac{1}{K_S} + \frac{1}{K_N} + \frac{1}{K_B} + \frac{1}{K_H} \dots\dots\dots(18)$$

Here:

- δ Feed-screw system elastic displacement in the axial direction (μm)
- F_a Axial load (kgf)
- K_T Axial rigidity of the feed-screw system ($kgf/\mu m$)
- K_S Axial rigidity of the screw shaft ($kgf/\mu m$)
- K_N Axial rigidity of the Nut ($kgf/\mu m$)
- K_B Axial rigidity of the support bearing ($kgf/\mu m$)
- K_H Rigidity of the Nut Bracket and support bearing bracket ($kgf/\mu m$)

Axial rigidity of Screw shaft: K_S

The axial rigidity of a screw shaft varies depending on the shaft mounting method.

- fixed - free (Axial direction)

$$K_S = \frac{A \times E}{x} \times 10^{-3} \dots\dots\dots(19)$$

Here:

- K_S Axial rigidity of Screw shaft ($kgf/\mu m$)
- A Screw shaft cross-sectional area ($A = \pi \cdot dr^2/4 \text{ mm}^2$)
- dr Screw shaft thread minor diameter (mm)
- E Young's modulus ($E = 2.1 \times 10^4 \text{ kgf/mm}^2$)
- x Distance between mounting positions (mm)

- fixed - fixed (Axial direction)

$$K_S = \frac{A \times E \times L}{x(L-x)} \times 10^{-3} \dots\dots\dots(20)$$

Here:

- K_S Axial rigidity of Screw shaft ($kgf/\mu m$)
- L Distance between mounting positions (mm)

Note: Which $x=L/2$, K_S becomes the minimum and the elastic displacement in the axial direction the maximum.

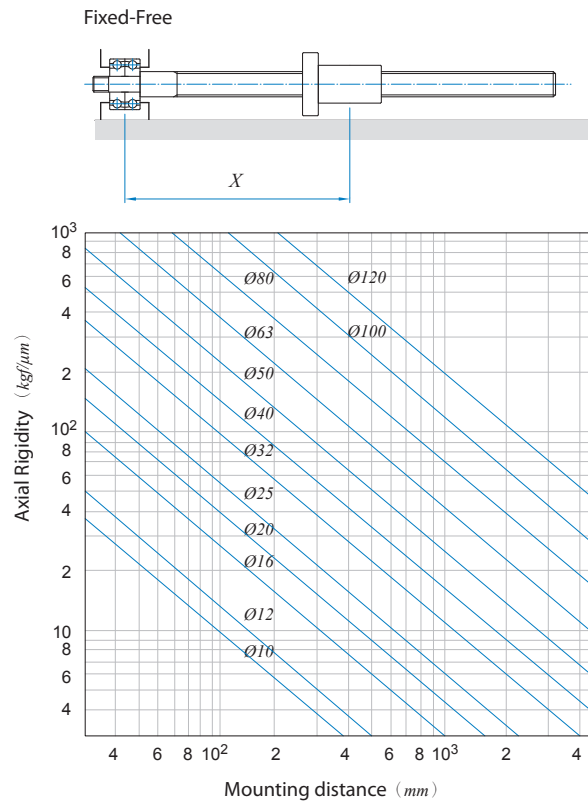

Fig.17 Rigidity of ball screw shaft (Fixed-Free)

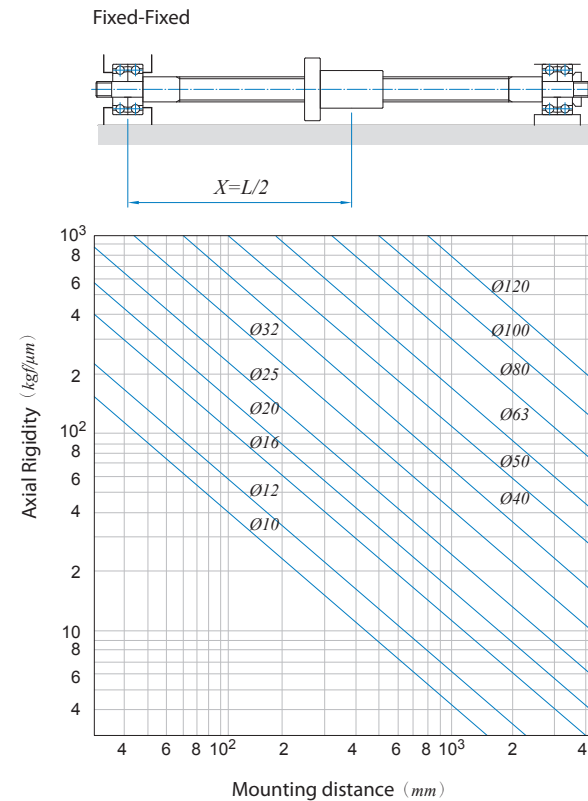

Fig.18 Rigidity of ball screw shaft (Fixed-Fixed)

Axial rigidity of Nut: K_N

Computation of the elastic displacement can be using equation (21):

$$\delta_a = \frac{C}{\sin \alpha} \left(\frac{Q^2}{D_w} \right)^{1/3} \times \zeta \quad (\mu m) \quad \dots\dots\dots(21)$$

Here:

- C A constant (reference $C \cong 2.4$)
- α Contact angle of ball and grooved
- D_w Ball diameter (mm)
- Q Load of each balls ($Q = Fa/Z \cdot \sin \alpha$ kgf)
- Z Number of balls
- ζ A coefficient of accuracy and inter conformation

- Non-preload type

Dimension tables include theoretical axial rigidity values when the axial load with a magnitude of 30% of the basic dynamic load rating (Ca) is exerted on the Nut. These values, don't consider the rigidity of the Nut mounting brackets. Therefore, as a general rule, take 80% of the values given in the table.

When the axial load with a magnitude other than 30% of the basic dynamic load rating (Ca) is exerted on the Nut, rigidity value can be calculated using equation (22).

$$K_N = 0.8 \times K \left(\frac{Fa}{0.3Ca} \right)^{1/3} \quad \dots\dots\dots(22)$$

Here:

- K Rigidity value given in the dimension table (kgf/ μm)
- Fa Axial load (kgf)
- Ca Basic dynamic load rating (kgf)

- Preloaded type

Dimension tables include theoretical axial rigidity values when the axial load with a magnitude of 10% of the basic dynamic load rating (Ca) is exerted on the Nut. These values, don't consider the rigidity of the Nut mounting brackets. Therefore, as a general rule, take 80% of the values given in the table.

When the axial load with a magnitude other than 10% of the basic dynamic load rating (Ca) is exerted on the Nut, rigidity value can be calculated using equation (23).

$$K_N = 0.8 \times K \left(\frac{Fao}{\epsilon \times Ca} \right)^{1/3} \quad \dots\dots\dots(23)$$

Here:

- K Rigidity value given in the dimension table (kgf/ μm)
- Fao Preload (kgf)
- ϵ A coefficient of rigidity
 $\epsilon = 0.10$ (spacer preload and offset preload)
 $\epsilon = 0.05$ (oversize preload)
- Ca Basic dynamic load rating (kgf)

Axial rigidity of support bearing: K_B

The axial rigidity of the support bearings for the Ballscrew varies by bearing type.

A typical calculation for determining the axial rigidity of an angular ball bearing can be made using equation (24).

$$K_B = \frac{3Fao}{\delta_{ao}} \quad \dots\dots\dots(24)$$

Here:

- δ_{ao} Displacement in the axial direction.

$$\left. \begin{aligned} \delta_{ao} &= \frac{0.44}{\sin \alpha} \left(\frac{Q^2}{D_w} \right)^{1/3} \\ Q &= \frac{Fao}{Z \times \sin \alpha} \end{aligned} \right\} \quad \dots\dots\dots(25)$$

- Fao Preload of the support bearing (kgf)
- α Initial contact angle of the support bearing (°)
- D_w Ball diameter of the support bearing (mm)
- Q Load of each balls
- Z Number of balls

Axial rigidity of nut bracket and support bearing bracket: K_H

Take this into consideration in the design of your system. Setting the rigidity as high as possible.

Torsional rigidity of the feed-screw system

The factors of positions error caused by twisting are:

- Torsional deformation of screw shaft.
- Torsional deformation of coupling.
- Torsional deformation of motor.

But above deformations are too small in general machine (non-high speed machine), they are then ignored.

Ballscrew's preload and effect

In order to get high positioning accuracy, there are two ways to reach it. One is commonly known as to clear axial play to zero. The other one is to increase Ballscrew rigidity to reduce elastic deformation while taking axial load. Both two ways are done by preloading.

Methods of preloading

- Double-nut method:

A spacer inserted between two nuts exerts a preload. There are two ways for it.

One is illustrated in Fig.19 That is to use a spacer with thickness complies with required magnitude of preload. The spacer makes the gap between Nut A and B to be bigger, hence to produce a tension force on Nut A and B. It is called "extensive preload".

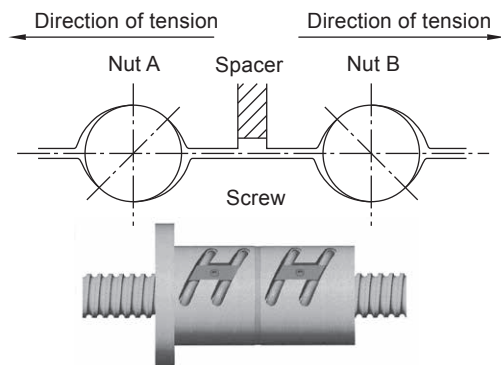

Fig.19 Extensive preload

Illustrated in Fig.20, is using a thinner spacer. The thickness complies with required magnitude of preload. The spacer is smaller than the gap between Nut A and B, compressing Nut A and B on opposite direction to preload Ballscrews. It's called "compressive preload".

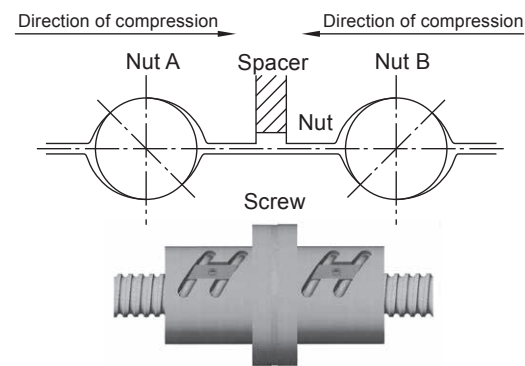

Fig.20 Compressive preload

- Single-nut method:

As that illustrated on Fig.21, using oversize balls onto the space between Ballnut and screw to get required preload. The balls shall make four-point contact with grooves of Ballnut and screw.

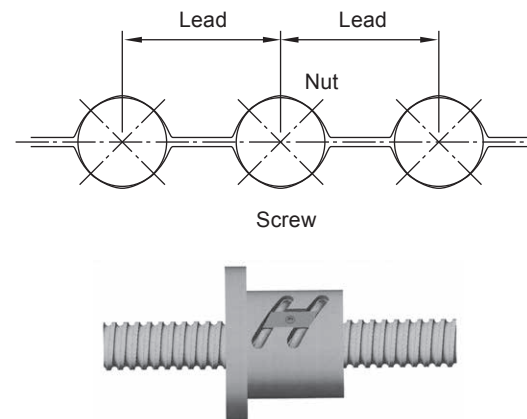

Fig.21 Four-point contact preload

There is another way for single nut Ballscrew preloading. That is to shift a very little distance, which complies with required magnitude of preload, on one lead of Ballnut as that illustrated on Fig.22 to preload Ballscrew.

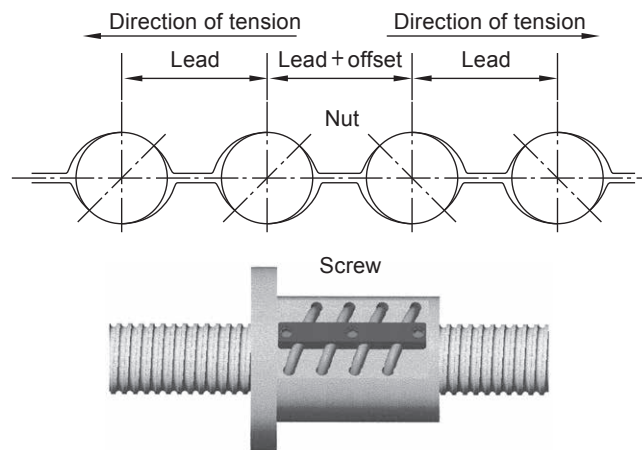

Fig.22 Lead offset preload

Relation between preload force and elastic deformation

Fig.23, Nuts A and B are assembled with preloading spacer. The preload forces on Nut A and B are F_{a0} , but with reversed direction. The elastic deformation on both Nuts are δ_{a0} .

Then there is a external axial force F_a applied to Nut A as shown on Fig.24. The deformation of Nut A and B becomes:

$$\delta_A = \delta_{a0} + \delta_{a1}$$

$$\delta_B = \delta_{a0} - \delta_{a1}$$

The load in nut A and nut B are:

$$F_A = F_{a0} + F_a - F_{a'} = F_a + F_p$$

$$F_B = F_{a0} - F_{a'} = F_p$$

Note: F_A and F_B are opposite direction.

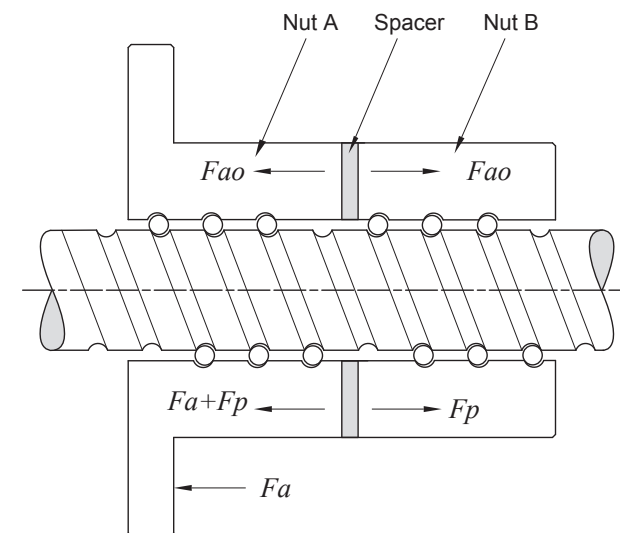

Fig.23 Double-nut positioning preload

It means F_a is offset with an amount F_a' because of the deformation of Nut B decreases. As a result, the elastic deformation of Nut A is reduced. This effect shall be continued until the deformation of Nut B becomes zero, that is, until the elastic deformation δ_{a1} caused by the external axial force equals δ_{a0} , and the preload force applied to Nut B is completely released.

The formula related the external axial force and elastic deformation is shown as below:

$$\delta_{a0} = K \times F_{a0}^{2/3} \text{ and } 2\delta_{a0} = K \times F_l^{2/3}$$

$$(F_l / F_{a0})^{2/3} = (2\delta_{a0} / \delta_{a0}) = 2$$

$$F_l = 2.8F_{a0} \approx 3F_{a0}$$

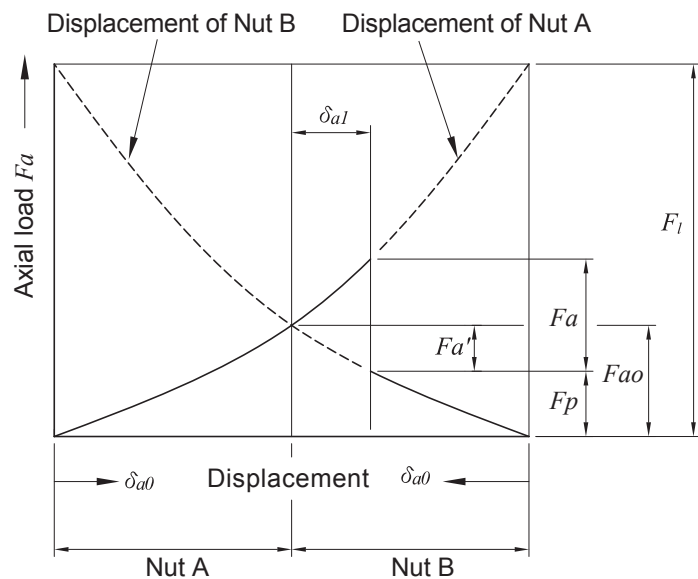

Fig.24 Positioning preload diagram

Therefore, the preload amount of a ballscrew is recommended to set as 1/3 of its axial load. Too much preload for a Ballscrew shall cause temperature raise and badly affect its life. However, taking the life and efficiency into consideration, the maximum preload amount of a Ballscrew is commonly set to be 10% of its rated basic dynamic load.

Shown on Fig.25, with the axial load to be three times as the preload, the elastic displacement for the non-preloaded ball nut is two times as that of the preloaded nut.

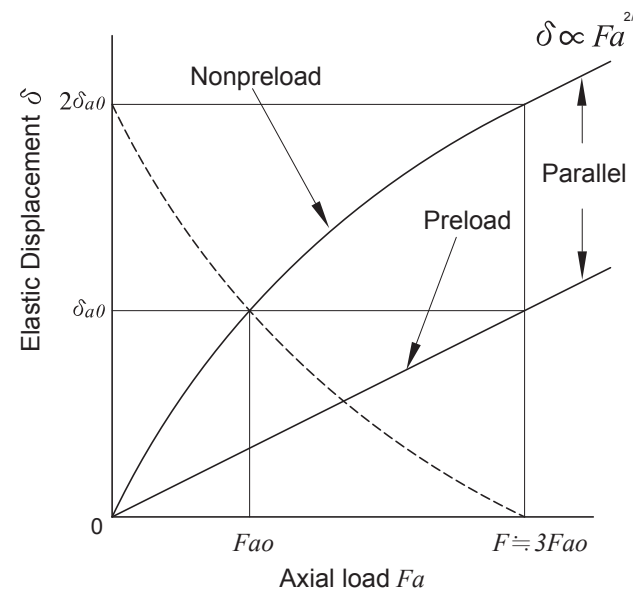

Fig.25 Elastic Displacement of the Ballscrew

Positioning Accuracy

Causes of Error in Positioning Accuracy

Lead error and rigidity of feed system are common causes of feed accuracy error. Other causes like thermal deformation and feed system assembly are also playing important roles in feed accuracy.

Selecting the Lead Accuracy

Refer to **page[A1-4]**, the Specified travel line should coincide with the nominal travel line. However, in order to compensate either the elongation caused by the thermal expansion during machine operating or the shortening of length due to external load, the specified travel may be set to be positive or negative to the Nominal travel. Machine designer can show the value of Specified travel on the drawing for our manufacturing, or, we can help to decide it based on our more than ten years experience.

There is another way to compensate thermal effect by "pretension" to Ballscrew. Generally, the pretension force shall elongate the Ballscrew to be equivalent to the thermal expansion at about 2-3°C.

Considering Thermal Displacement

If the screw-shaft temperature increases during operation, the heat elongates the screw shaft, thereby reducing the positioning accuracy. Expansion and shrinkage of a screw shaft due to heat can be calculated using equation (26).

$$\Delta L_{\theta} = \rho \cdot \theta \cdot L \dots\dots\dots(26)$$

Here:

- ΔL_{θ} Thermal displacement (μm)
- ρ Thermal-expansion coefficient ($12 \mu m/m^{\circ}C$)
- θ Screw-shaft temperature change ($^{\circ}C$)
- L Ballscrew length (mm)

That is to say, an increase in the screw shaft temperature of 1°C expands the shaft by 12 μm per meter. The higher the Ballscrew speed, the greater the heat generation. Thus, temperature increases reduce positioning accuracy. Where high accuracy is required, anti-temperature-elevation measures must be provided as follows:

To control temperature:

- Selecting appropriate preload.
- Selecting correct and appropriate lubricant.
- Selecting larger lead for the Ballscrew and decrease the rotation speed.

Compulsory cooling:

- Ballscrew with hollow cooling.
- Lubrication liquid or cooling air can be used to cool down external surface of Ballscrew.
- Nut cooling system: to reduce temperature of nut by cooling liquid through it.

To keep off effect upon temperature raise:

- Set a negative cumulative lead target value for the Ballscrew.
- Warm up the machine to stable machine's operating temperature.
- Pretension by using on Ballscrew while installing onto the machine.
- Use the Closed-loop positioning control.

Life of the Ballscrew

Even though the Ballscrew has been used with correct manner, it shall naturally be worn out and can no longer be used for a specified period. Its life is defined by the period from starting use to ending use caused by nature fail.

- a. Fatigue life - Time period for surface flaking off happened either on balls or on thread grooves.
- b. Accuracy life - Time period for serious losing of accuracy caused by wearing happened on thread groove surface, hence to make Ballscrew can no longer be used.

Fatigue Life

The basic dynamic rate load (C_a) of the Ballscrew is used to calculate its fatigue life when it is operated under a load.

Basic dynamic rate load C_a

The basic dynamic rate load (C_a) is the revolution of 10^6 that 90% of identical Ballscrew units in a group, when operated independently of one another under the same conditions, can achieve without developing flaking.

Fatigue life

Calculating life

There are three ways to show fatigue life:

- Total number of revolutions
- Total operating time.
- Total travel.

$$L = \left(\frac{C_a}{F_a \times f_w} \right)^3 \times 10^6 \dots\dots\dots(27)$$

$$L_t = \frac{L}{60 \times n} \dots\dots\dots(28)$$

$$L_s = \frac{L \times l}{10^6} \dots\dots\dots(29)$$

here:

- L Fatigue life (total number of revolutions)(rev)
- L_t Fatigue life (total operating time)(hr)
- L_s Fatigue life (total travel)(km)
- C_a Basic dynamic rate load(kgf)
- F_a Axial load(kgf)
- n Rotation speed(rpm)
- l Lead(mm)
- f_w Load factor (refer to Table 14)

Table 14 Load factor f_w

Vibration and impact	Velocity (V)	f_w
Light	$V < 15$ (m/min)	1.0~1.2
Medium	$15 < V < 60$ (m/min)	1.2~1.5
Heavy	$V > 60$ (m/min)	1.5~3.0

Too long or too short fatigue life are not suitable for Ballscrew selection. Using longer life make the Ballscrew's dimensions too large. It's an uneconomical result. Following table is a reference of the Ballscrew's fatigue life.

- Machine center 20,000 hours
- Production machine 10,000 hours
- Automatic controller 15,000 hours
- Surveying instruments 15,000 hours

Mean load

When axial load changed constantly. It is required to calculate the mean axial load (F_m) and the mean rotational speed (N_m) for fatigue life. Setting axial load (F_d) as Y-axis; rotational number (n, t) as X-axis. Getting three kind curves or lines:

- Gradational variation curve (Fig.26[A1-53])

Mean load can be calculated by using equation (30):

$$F_m = \left(\frac{F_1^3 \cdot n_1 \cdot t_1 + F_2^3 \cdot n_2 \cdot t_2 + \dots + F_n^3 \cdot n_n \cdot t_n}{n_1 \cdot t_1 + n_2 \cdot t_2 + \dots + n_n \cdot t_n} \right)^{\frac{1}{3}} \dots\dots\dots(30)$$

Mean rotational speed can be calculated by using equation (31):

$$N_m = \frac{n_1 \cdot t_1 + n_2 \cdot t_2 + \dots + n_n \cdot t_n}{t_1 + t_2 + \dots + t_n} \dots\dots\dots(31)$$

Axial load (kgf)	Rotation speed (rpm)	Time Ratio (Sec or %)
F_1	n_1	t_1
F_2	n_2	t_2
⋮	⋮	⋮
F_n	n_n	t_n

- Similar straight line (Fig.27)

When mean load variation curve like similar straight line. Mean rotational speed can be calculated using equation (32).

$$F_m = 1/3(F_{min} + 2F_{max}) \dots\dots\dots(32)$$

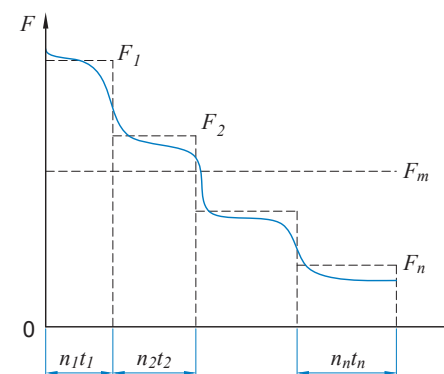

Fig.26 Gradational variation curve's load

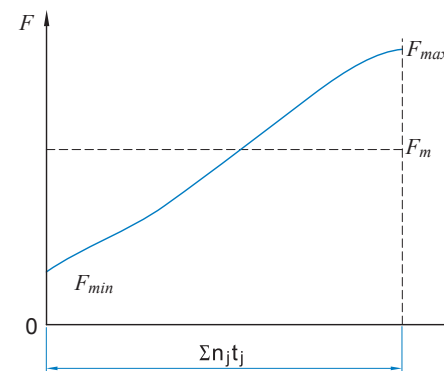

Fig.27 Similar straight line's load

• Sine curve there are two cases

1. When mean load variation curve shown as the Fig.28 below. Mean rotational speed can be calculated by using equation (33):

$$F_m = 0.65F_{max} \dots\dots\dots(33)$$

2. When mean load variation curve shown as the Fig.29 below. Mean rotational speed can be calculated by using equation (34):

$$F_m = 0.75F_{max} \dots\dots\dots(34)$$

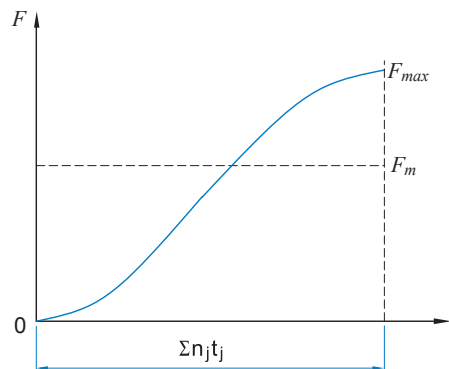

Fig.28 Variation like Sine curve's load (1)

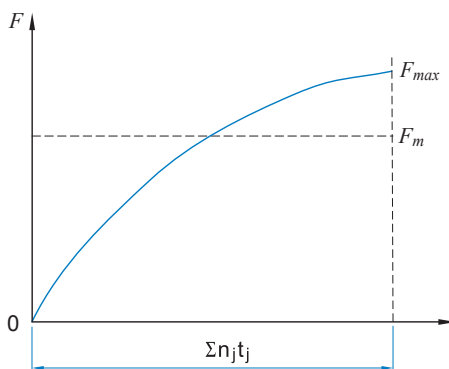

Fig.29 Variation like Sine curve's load (2)

Affection of installation errors

When twist load or radial load is applied to Ballscrew, there shall be bad effect on ballscrew operation and its life, It is required to make the feed system (Ballscrew, support bearings, Guideways) to be more rigid. Hence to reduce. installation errors.

Ballscrews must be meticulously installed onto the Yoke (bracket) of machine to achieve precise parallelism and squareness along moving direction of moving parts. It is very important to ensure minimum backlash happens.

Scales of reference calculate for support torque of ball screw, allow Fig.30

Nut type : R40-10B2-FSWC
specification

- shaft diameter : 40 mm
- ball diameter : 6.35 mm
- effective turns : 2.5 circuit x 2 row
- Axial play : 50 μm

conditions

- Axial force $F_a=300$ kgf
- Radial displacement:0

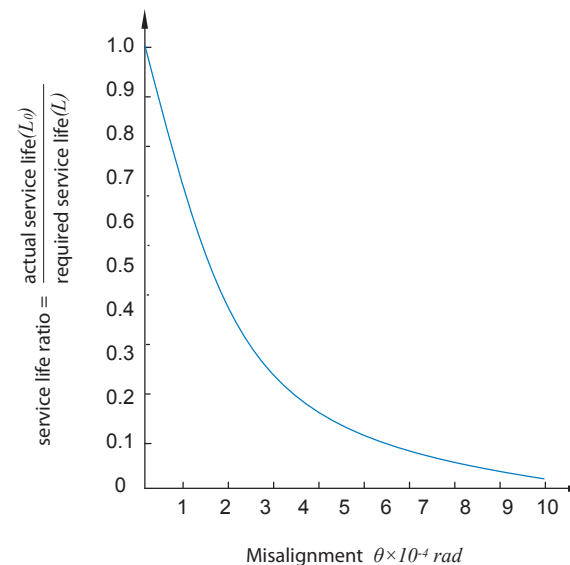

Fig.30 The effect on service life of a radial load caused by misalignment

Permissible Load on Thread Grooves

Even though the Ballscrew is seldom operated and is operated under low velocity, it is required to make the maximum load to be far smaller than its rated basic static load when making selection.

Basic static rate load C_o

The basic static rate load is the static load with a non-varying direction and magnitude that makes the sum of the permanent deformation of the rolling elements and raceway 0.0001 times the rolling element diameter. With the Ballscrew, the basic static rate load is defined in relation to the axial load.

Permissible axial load

$$F_{max} = C_o / f_s$$

Here:

- f_s Static safety factor
- General industrial machine.....1.2~2
- Machine tool.....1.5~3

Material and Hardness

Material and Hardness of *PMI* Ballscrews

Table 15 Material and hardness of Ballscrews

Denomination	Material	Heat treating	Hardness (HRC)
Precision ground	50CrMo4 QT/Equivalent	Induction hardening	58~62
Rolled	S55C/Equivalent	Induction hardening	58~62
Nut	SCM420H/Equivalent	Carburized hardening	58~62

Hardness factor

If used *PMI*'s standard materials else one, for a surface hardness of less than HRC58, the basic dynamic rate load (C_a) and the basic static rate load (C_o) must be adjusted. Adjustment is made by the following formula. Show in Fig.31

$$C_a' = f_{H'} \times C_a$$

$$C_o' = f_{H'} \times C_o$$

Here:

- $f_{H'}$ Hardness coefficient
- $f_{H''}$ Static Hardness coefficient

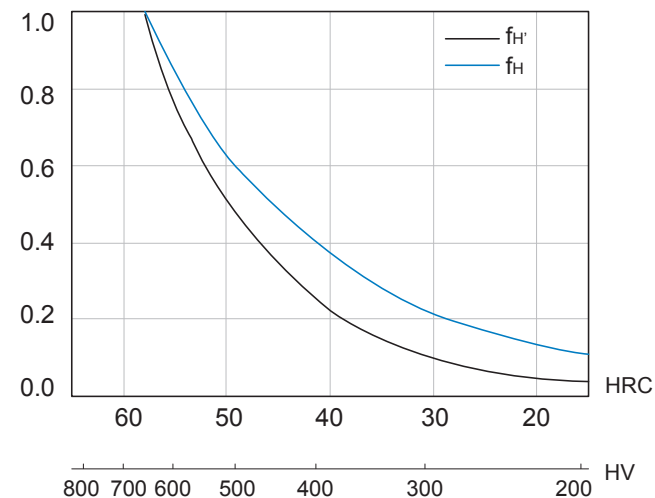

Fig.31 Hardness coefficient

Heat Treating Inspection Certificate



PRECISION MOTION INDUSTRIES, INC.

REPORT FOR HEAT TREATING INSPECTION



SPECIMEN#	P90227	P.O. NUMBER	SPECIFICATION
CUSTOMER			
PRODUCT	BALLSCREW	03-016030-1	R38-15B2-FSVC-557-685.8-C4
MATERIAL	50CrMo4QT		
HEATTREAT	INDUCTION SURFACE HARDENING		

ITEM	INSPECTION DATA	HEATTREATED ARE (SEESKETCH) 
HARDNESS	58 - 62 HRC AT SURFACE	
CASEDEPTH	1.5 mm BELOW THREAD ROOT	
MICRO-STRUCTURE	Martensite IN SURFACE AREA Sorbite IN CORE AREA	
TEMPERING	AT 160 DEGREES CELCIUS	

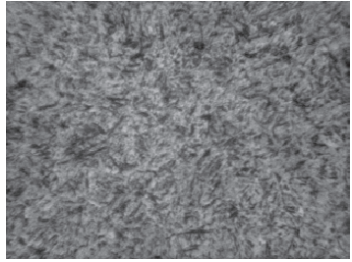
DEPTH	Series1	Series2	
0	725	718	
1	705	698	
2	704	705	
3	698	681	
4	694	642	
5	679	562	
6	625	277	
7	547	277	
8	390		
9	286		
10	288		
11			
12			
13			
14			
15			

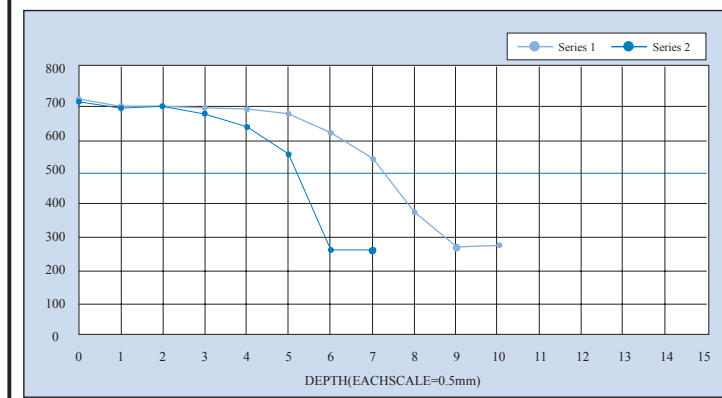

HV VS. HRC	
HV	HRC
800	64.0
780	63.3
760	62.5
740	61.8
720	61.0
700	60.1
690	59.7
680	59.2
670	58.8
660	58.3
650	57.8
640	57.3
630	56.8
620	56.3
610	55.7
600	55.2
590	54.7
580	54.1
570	53.6
560	53.0
540	51.7
520	50.5
500	49.1
480	47.7
460	46.1
440	44.5
420	42.7
400	40.8
380	38.8
360	36.6
340	34.4
320	32.2
300	29.8
280	27.1
260	24.0
240	20.3

REMARKS	PASS OR NOT	Q.C.CHIEF	INSPECTOR
---------	-------------	-----------	-----------

Lubrication

Lithium base lubricants are used for Ballscrew lubrication. Their viscosity are 30~140 cst (40°C) and ISO grades of 32~100.

Selecting:

- 1.High speed or Low temperature application: Using the lower viscosity lubricant.
- 2.High temperature, high load and low speed application: Using the higher viscosity lubricant.

Table 16 Checking and supply interval of lubricant

Manner	Checking interval	Checking item	Supply or replacing interval
Automatic interval oil supply	every week	oil volume and purity	To supply on each check, its volume depends on oil tank capacity
Lubricating grease	Within 2-3 months after starting operation of machine	foreign matter	Normally supply once a year as per the result of check
Oil bath	everyday before operation of machine	oil surface	To supply as per wasting condition

Table 17 calculate of supply lubricate oil

Lubrication method	Principles of inspection and add
oil	<p>Checked and add depending on the tank capacity every week. Oil should be changed when oil is dirty.</p> <p>Calculation of oil Capacity: Capacity of supply oil every 10 min. $Q = \frac{\text{Shaft diameter (mm)}}{90} \text{ c.c.} \dots\dots(35)$</p>

Table 18 calculate of supply lubricate grease

Lubrication method	Principles of inspection and add
grease	<p>Checked every 2~3 months after begin of the operation and see whether foreign matter. Change grease when dirty.</p> <p>Add grease depending on the use condition and operation environment. The add capacity should be the 50% of the internal volume of the nut.</p> <p>Avoid using different brands of grease</p>

Ball diameter d	Ø1.588	Ø2.0	Ø2.381	Ø2.778	Ø3.175	Ø3.969	Ø4.762
G value	0.8	1.0	1.0	1.5	1.2	1.3	2.0

Ball diameter d	Ø6.350	Ø7.144	Ø7.938	Ø9.525	Ø12.7	Ø15.875	Ø19.05
G value	3.0	3.5	3.9	5.0	6.0	9.6	12

$$Q = \left[\left(\sqrt{(\pi \times dm)^2 + Ld^2} \times \pi d^2 \times \text{effective turns} \right) \times \frac{1}{1000} + \left(\frac{\pi L \times (2DG + G^2)}{4} \right) \right] \times \frac{1}{1100} \dots\dots(36)$$

- Q Capacity of supply lubricate grease(cm³)
- D Shaft diameter(mm)
- d Ball diameter(mm)
- dm Ball circle diameter(mm)
- G Size factor of ball
- Ld Lead(mm)
- L Length of Nut(mm)

Dustproof

Same as the rolling bearings, if there is the particles such as chips or water get into the ballscrew, the wearing problem shall be deteriorated. In some serious cases, ballscrew shall then be damaged. In order to prevent these problems from happening, there are wipers assembly at both ends of ballnut and please use the Screw cover or Bellows for better dustproof. Should there be any more information required, please contact us. There is also the "O-Ring" at the wipers to seal the lubrication oil from leaking from ballnut.

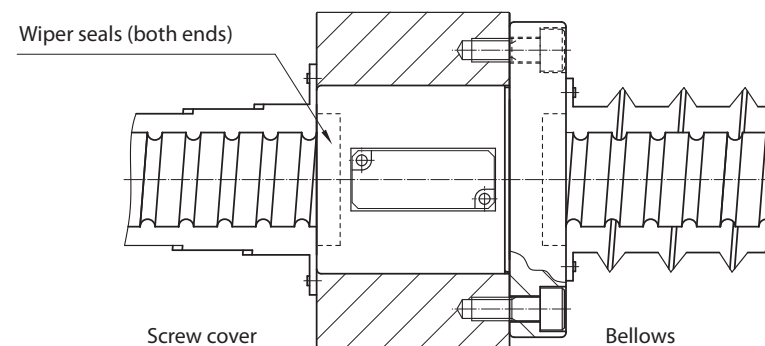

Dustproof by screw cover and bellows

Operating Torque of Ballscrew

Normal Drive

Rotational motion converted to linear motion is called normal drive. The torque required can be obtained by using equation (37)

$$T_a = \frac{F_a \times l}{2\pi \times \eta_1} \dots\dots\dots(37)$$

Reverse operation

Linear motion converted rotational motion is called reverse operation motion. The torque required can be obtained using equation (38)

$$T_b = \frac{F_a \times l \times \eta_2}{2\pi} \dots\dots\dots(38)$$

Preload torque

Friction torque due to preload on the Ballscrew, The torque required can be obtained by using equation (39)

$$T_p = k \times \frac{F_{ao} \times l}{2\pi} \dots\dots\dots(39)$$

Here:

- T_a Normal operation torque
- F_a Axial load
- l Lead
- η Normal efficiency

Here:

- T_b Reverse operation torque
- η_2 Reverse efficiency

here:

- T_p Preload torque
 - F_{ao} Preload
 - k Coefficient of preload
- torque see equation (1)

[A1-12]

$$k = 0.05 \times (\tan\beta)^{-0.5}$$

Drive Torque of Motor

Driving torque at constant speed

The torque can counteract load and let Ballscrew to rotate uniformly is called driving torque for constant speed. Driving torque = preloading torque + friction torque for axial load + friction torque for bearing.

$$T_1 = \left(k \times \frac{F_{ao} \cdot l}{2\pi} + \frac{F_a \cdot l}{2\pi \cdot \eta} + T_B \right) \times \frac{N_1}{N_2} \dots\dots\dots(40)$$

Here:

- T_1 Driving torque at constant speed
- F_{ao} Preload
- F_a Axial load
- F Cutting resistance
- μ Guiding surface friction coefficient
- W Total weight (Working table weight + Working object weight)
- T_B Friction torque for bearing
- N_1 Gear one
- N_2 Gear two

In general, driving torque of constant speed motion shall not over than 30% of rated torque of motor.

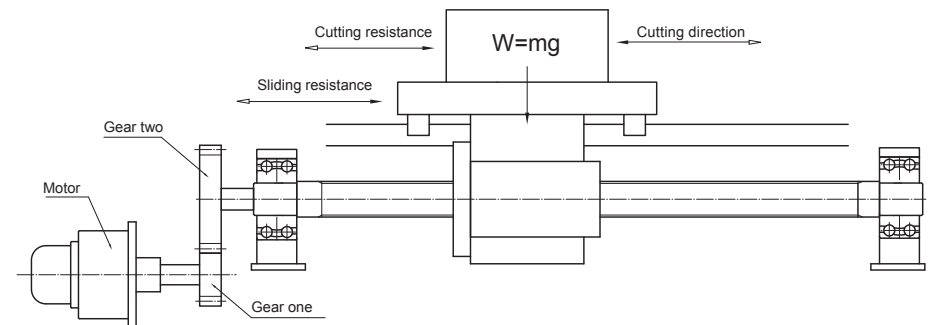

Fig.32 Cutting machine diagram

Driving torque at constant acceleration

The torque required to counteract load and to let Ballscrew to rotate at constant acceleration is driving torque at constant acceleration.

$$T_2 = T_l + J \cdot \dot{\omega} \quad \dots\dots\dots(41)$$

$$J = J_M + J_{G1} + \left(\frac{N_1}{N_2}\right)^2 \times [J_{G2} + J_{SH} + J_w + J_C] \quad \dots\dots\dots(42)$$

$$J_w = \frac{m}{g} \left(\frac{l}{2\pi}\right)^2 \quad \dots\dots\dots(43)$$

Here:

- T_2 Driving torque at constant acceleration
- $\dot{\omega}$ Motor's angular acceleration
- J Total inertial
- J_M Inertial of motor
- J_{G1} Inertial of gear one
- J_{G2} Inertial of gear two
- J_{SH} Inertial of screw shaft
- J_w Inertial of moving parts (Ballscrew, Table)
- J_C Inertial of Coupling
- m Total Masses (Working table mass + working piece mass)
- l Lead
- g Gravitational acceleration

• Cylindric inertia (Ballscrew, gear)

$$J = \frac{1}{32} \rho \pi D^4 L \quad (kg \cdot m^2) \quad \dots\dots\dots(44)$$

$$= \frac{\pi \gamma}{32g} D^4 L \quad (kg \cdot m^2) \quad \dots\dots\dots(45)$$

$$= \frac{mD^2}{8} \quad (kg \cdot m^2) \quad \dots\dots\dots(46)$$

Here:

- ρ Material Density
- γ Specific Gravity
- D Diameter of Cylinder
- L Length of Cylinder
- m Mass of Cylinder

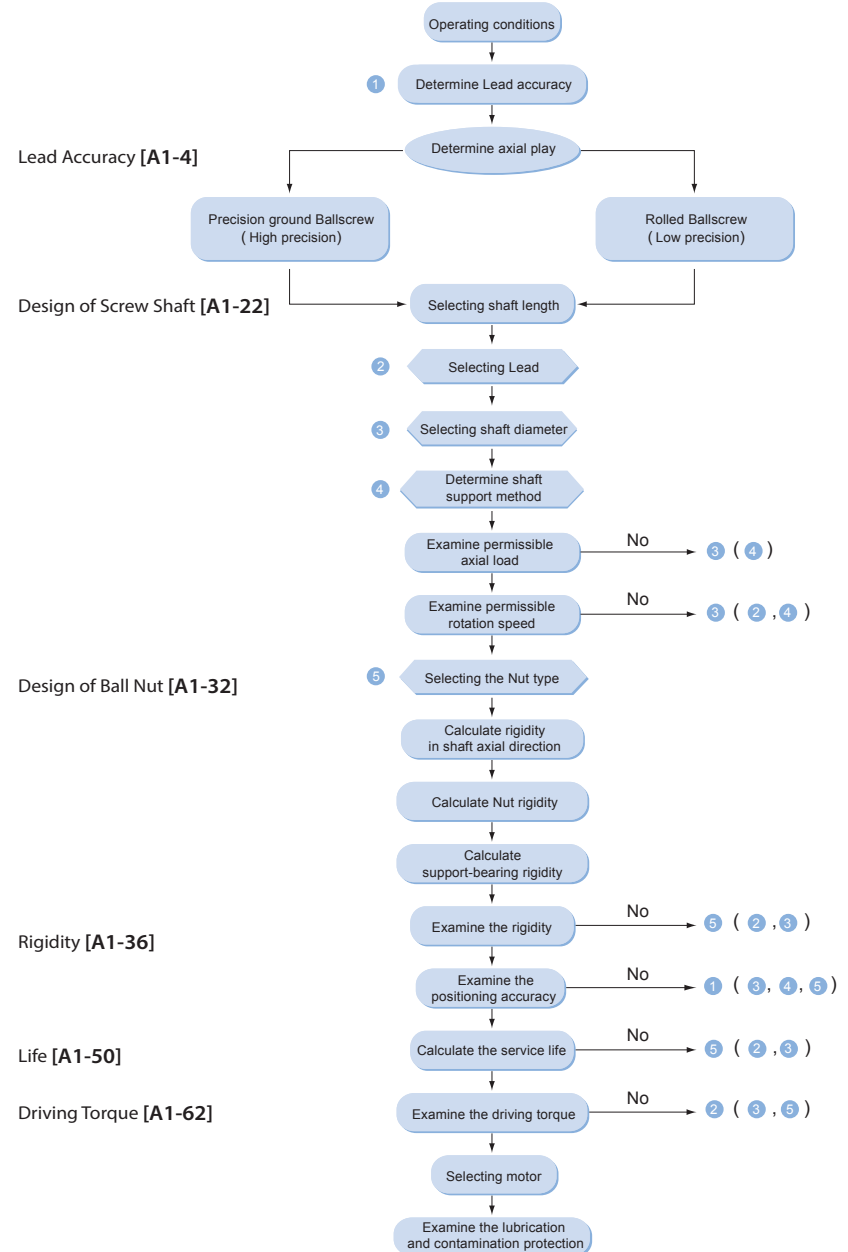

Nomenclature of PMI Ballscrew

Nomenclature of External Circulation Ballscrew

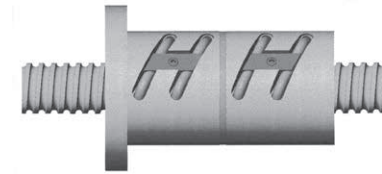

TYPE
FDWC



TYPE
DFWC

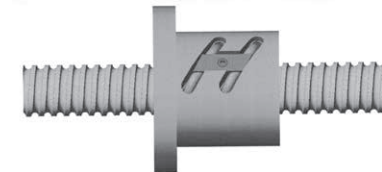

TYPE
FSWC

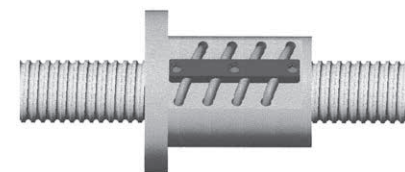

TYPE
FOWC

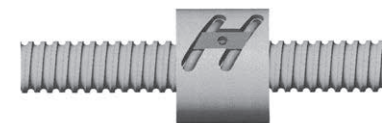

TYPE
RSWC

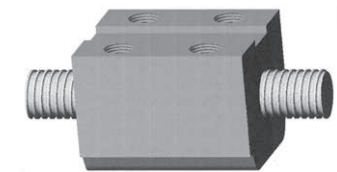

TYPE
SSWC

Nomenclature of Internal Circulation Ballscrew

1R50-10T 4-2FS I C -1000 -1500 -0.018 R

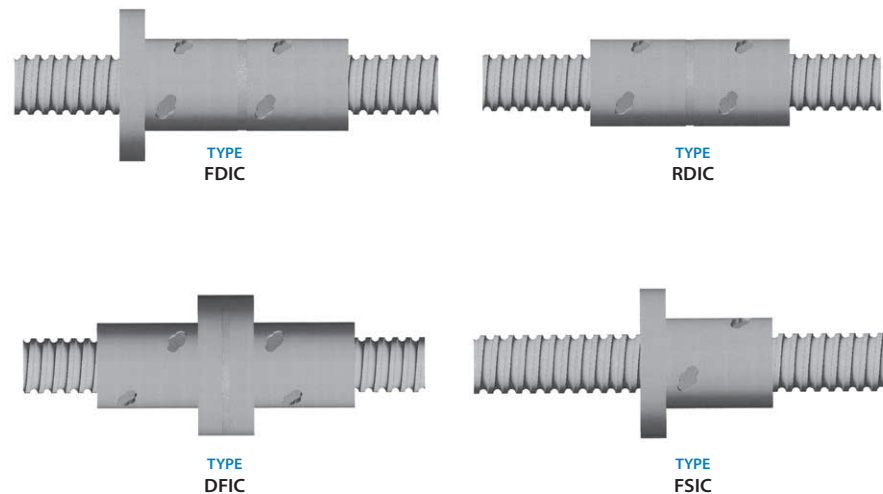
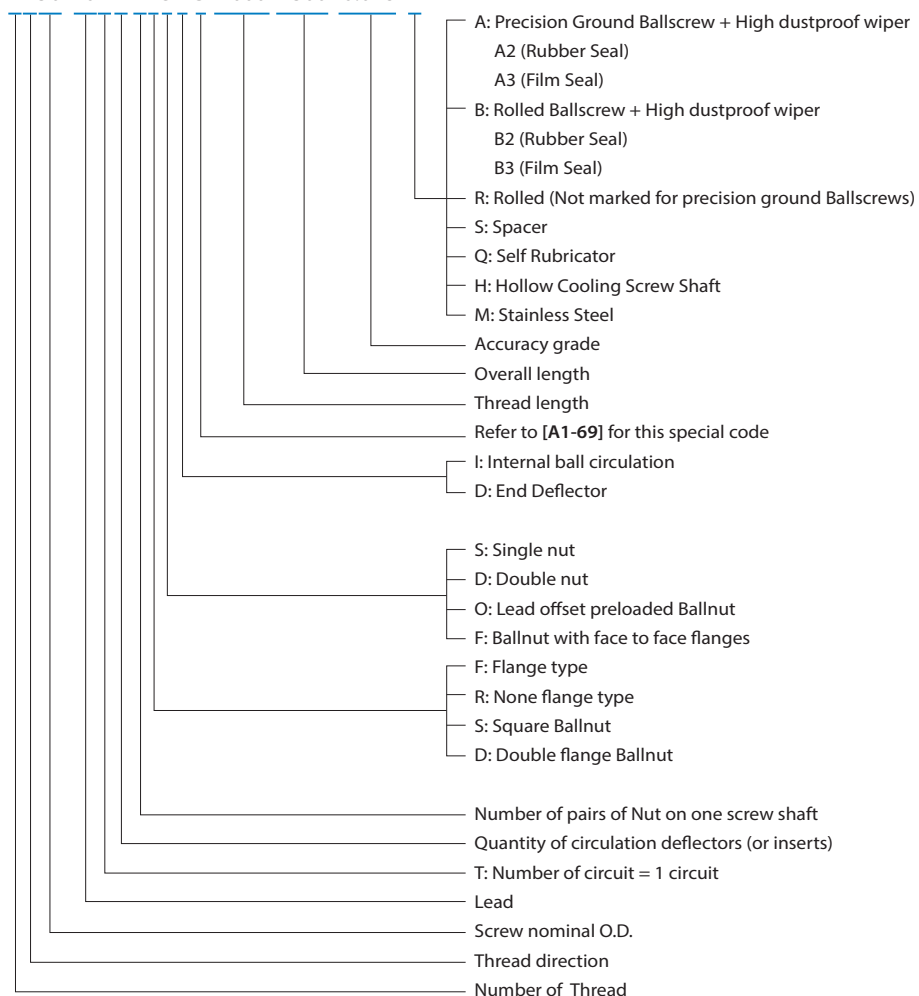

Table19 Special Code for Nut

C	Ground Grade
W	Rolled Grade
E	High Lead Ballscrews
H	Heavy Load Ballscrews
N	Rolled Grade (DIN 69051 Nut Dimension)
U	Rolled Grade + Seal (DIN 69051 Nut Dimension)
M	Automation Industry Specialized Type
A	Deflector Type Cooling Nut- Recirculation Type
B	Deflector Type Cooling Nut- Direct Passing Type
K	High Lead Type Cooling Nut- Recirculation Type
T	Rotation Nut Type
S	High Lead Low Noise Type

Sample Process of Selecting The Type of Ballscrew

Cutting Machine

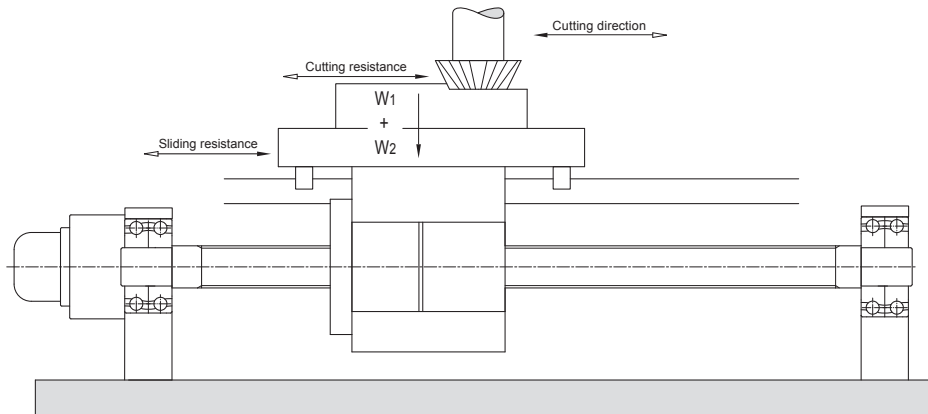

Fig.33 Cutting machine

Design Conditions

Table weight:	$W_1 = 1100 \text{ kg}$
Work piece weight:	$W_2 = 800 \text{ kg}$
Max. travel:	$S_{max} = 1000 \text{ mm}$
Rapid feed speed:	$V_{max} = 14 \text{ m/min}$
Life:	$L_t = 25000 \text{ h}$
Sliding surface friction coefficient:	$\mu = 0.1$
Driving motor:	$N_{max} = 2000 \text{ rpm}$
Positioning accuracy:	$\pm 0.030/1000 \text{ mm}$ (no load)
Repeatability accuracy:	$\pm 0.005 \text{ mm}$ (no load)
Lost Motion:	0.02 mm (no load)

Mechanical Conditions

Calculation data Kinds of Operation	Axial load (kgf)		Feed speed mm/min	Time ratio(%)
	Cutting resistance	Sliding resistance		
Rapid feed	0	190	14000	30
Light cutting	500	190	600	55
Heavy cutting	950	190	120	15

Sliding resistance: $F_a = \mu (W_1 + W_2)$
 $= 0.1 \times (1100 + 800)$
 $= 190 \text{ (kgf)}$

Items to Be Decided

- Screw nominal O.D., Lead, Type of Nut
- Accuracy grade
- Thermal displacement
- Driving motor

Selecting Screw nominal O.D., Lead, Nut

- Lead (l):

The highest rotation speed of motor

$$l \geq \frac{V_{max}}{N_{max}} = \frac{14000}{2000} = 7 \text{ (mm)}$$

☉Lead have to be 7mm or more.

(As per PMI catalog: select 8 and 10 mm for further analysis)

- Basic dynamic rate load (Ca)

Kinds of Operation	Calculation data	Feed speed		Time
	Axial load	l = 8	l = 10	ratio(%)
Rapid feed	F ₁ = 190	N ₁ = 1750	N ₁ = 1400	t ₁ = 30
Light cutting	F ₂ = 690	N ₂ = 75	N ₂ = 60	t ₂ = 55
Heavy cutting	F ₃ = 1140	N ₃ = 15	N ₃ = 12	t ₃ = 15

Calculation of mean load and mean rotation

$$\text{Mean load } F_m = \left(\frac{F_1^3 \cdot n_1 \cdot t_1 + F_2^3 \cdot n_2 \cdot t_2 + \dots + F_n^3 \cdot n_n \cdot t_n}{n_1 \cdot t_1 + n_2 \cdot t_2 + \dots + n_n \cdot t_n} \right)^{\frac{1}{3}}$$

$$\text{Mean rotation } N_m = \frac{n_1 \cdot t_1 + n_2 \cdot t_2 + \dots + n_n \cdot t_n}{t_1 + t_2 + \dots + t_n}$$

Lead l (mm)	8	10
Mean load F _m (kgf)	330	330
Mean rotation N _m (rpm)	569	455

Calculation of basic dynamic rate load

$$L = \left(\frac{Ca}{Fa \times f_w} \right)^3 \times 10^6 \quad L_t = \frac{L}{60N_m}$$

$$\Rightarrow Ca = (60N_m \times L_t)^{\frac{1}{3}} \times F_m \times f_w \times 10^{-2}$$

As per design Conditions:

$$L_t = 25000 \text{ (hours)}$$

$$f_w = 1.2$$

When l=8(mm)Ca ≥ 3756 (kgf)

If life > 25000 (hours) is needed,

Ca must be > 3756 (kgf)

When l=10(mm)Ca ≥ 3487 (kgf)

If life > 25000 (hours) is needed,

Ca must be > 3487 (kgf)

- Selecting the type of nut

In case stiffness is a major concern, lost motion becomes less important, following specifications are to be selected:

- 1.External circulation Ballscrew
- 2.Type: FDWC
- 3.Number of circuit: B×2 or B×3

The value of Ca can be found as per this catalog:

Unit: (kgf)

Screw nominal O.D.(mm)	lead 8 (mm)		lead 10 (mm)	
	B×2	B×3	B×2	B×3
32	3210	-	4660	-
36	3265	-	4930	-
40	3410	-	5220	-
45	3650	5175	5480	7760
50	3900	5520	5790	8200

- Selecting screw shaft diameter

Ballscrew shaft diameter can be decided by critical rotation speed of high speed feed.

Assume both of the supporting ends are fixed.

So the permissible rotational speed :

$$n = \alpha \times \frac{60\lambda^2}{2\pi L^2} \sqrt{\frac{EIg}{rA}} = f \frac{dr}{L^2} \times 10^7$$

$$\Rightarrow dr \geq \frac{n \times L^2}{f} \times 10^7$$

L = Max. stroke + Nut length/2 + Unthread area length

$$= 1000 + 100 + 200 = 1300 \text{ (mm)}$$

Screw shaft supported method is fixed-fixed

$$\Rightarrow f = 21.9$$

when $l=8$ (mm) $dr \geq 13.5$ (mm)

If the highest rotational speed reaches 1750 rpm,

screw shaft diameter at thread root area must be bigger than 14 mm.

©So screw shaft diameter shall be ranged in between 20 and 50 mm.

When $l=10$ (mm) $dr \geq 10.8$ (mm)

If the highest rotational speed reaches 1400 rpm,

screw shaft diameter at thread root area must be bigger than 11 mm.

©So screw shaft diameter shall be ranged in between 16 and 50 mm.

- Considering rigidity

By initial conditions:

Lost motion : 0.02 mm (no load)

Assume total displacement of components (including screw shaft, ballnut and support bearing)

of feed system is 0.016 mm. Thus the unilateral elastic displacement of feed system is $\Delta L \leq 8$ (μm)

Axial rigidity of the screw shaft: K_S

Elastic displacement of the screw shaft: ΔL_S

$$K_S = \frac{A \times E \times L}{x(L-x)} \times 10^{-3}$$

The smallest elastic displacement is in the middle of screw shaft.

From following diagram Using $x=L/2$

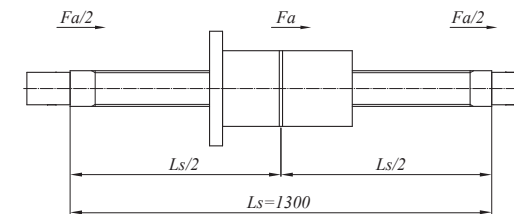

$$\Rightarrow K_S = \frac{\pi \times dr^2 \times E}{L_S} \times 10^{-3}$$

$$\Delta L_S = \frac{Fa}{K_S} = \frac{Fa \times L_S}{\pi \times dr^2 \times E} \times 10^3$$

Here Fa is sliding resistance of 190 (kgf)

The results are in the [A1-76] Table

Axial rigidity of the nut: K_n

Elastic displacement of the nut: ΔL_n

Setting the preload to be 1/3 of maximum axial load.

$$F_{ao} = F_{max} / 3 = 1140 / 3 = 380 \text{ (kgf)}$$

$$K_n = 0.8 \times K \left(\frac{F_{ao}}{\varepsilon \times C_a} \right)^{1/3}$$

$$\varepsilon = 0.1, \text{ then}$$

$$\Delta L_n = \frac{Fa}{K_n}$$

The results are in the [A1-76] Table

Nut model no.	dr	Ca	K	Screw		Nut		Total
				K_s	ΔL_s	K_n	ΔL_n	
32-10B2-FDWC	27.05	4660	125	37.1	5.1	93.0	2.0	7.1
36-10B2-FDWC	31.05	4930	138	48.9	3.9	101.2	1.9	5.8
40-10B2-FDWC	35.05	5220	151	62.3	3.0	108.7	1.7	4.7
45-10B2-FDWC	38.05	5480	167	73.5	2.6	118.3	1.6	4.2
50-10B2-FDWC	42.05	5790	182	89.7	2.1	126.5	1.5	3.6

©With the condition of $\Delta L \leq 8 (\mu m)$

Make following selection by ignoring the bearing rigidity, economical and safety consideration:

Type of Ballscrew: 40-10B2-FDWC

Screw shaft diameter: 40 (mm)

Lead: 10 (mm)

• Length of Ballscrew

$$L = \text{Max. travel} + \text{Nut length} + \text{Unthreaded area length}$$

(including journal ends length)

$$= 1000 + 180 + 100$$

$$= 1280$$

$$\approx 1300 \text{ (mm)}$$

• Preliminary check

a. Fatigue life

$$L_t = \left(\frac{Ca}{F_m \times f_w} \right)^3 \times 10^6 \times \frac{1}{60n}$$

$$= \left(\frac{5220}{330 \times 1.2} \right)^3 \times 10^6 \times \frac{1}{60 \times 455}$$

$$\approx 83900 \text{ (hours)} \geq 25000 \text{ (hours)}$$

b. Permissible rotational speed

$$n = f \times \frac{dr}{L^2} \times 10^7$$

$$= 4540 \text{ (rpm)}$$

Critical speed of screw shaft is 4540 (rpm). It is much bigger than the maximum rotational speed of design. So the Ballscrew selected is safe.

Selecting lead accuracy

Positioning accuracy required: $\pm 0.030/1000$ mm (Max. travel) Refer to Table 2[A1-6], accumulated reference lead deviation ($\pm E$) and total relative variation (e)

Accuracy grades: C4

$$E = \pm 0.025/1250 \text{ (mm)}$$

$$e = 0.018 \text{ (mm)}$$

Considering thermal displacement

According to the load capability of support bearings, make the specified travel (T) compensation to be 3°C

• Thermal displacement: ΔL_θ

$$\Delta L_\theta = \rho \cdot \theta \cdot L$$

$$= 12.0 \times 10^{-6} \times 3 \times 1300$$

$$= 0.047 \text{ (mm)}$$

• Pretension force: F_θ

$$F_\theta = \Delta L_\theta \times K_s = \frac{\Delta L_\theta \cdot E \cdot \pi dr^2}{4L}$$

$$= \frac{0.047 \times 2.1 \times 10^4 \times \pi \times 27.05^2}{4 \times 1300}$$

$$= 436 \text{ (kgf)}$$

Specified Travel (T): -0.047/1300

Pretension force: 436 (kgf)

Stretching: -0.047 (mm)

Selecting driving motor

<Required specifications>

The highest rotation speeds is 1500 (rpm)

Time required to reach highest rotational speed is within 0.15 sec.

• Inertial

a. Screw shaft:

$$GD_s^2 = \frac{\pi \rho}{8} \times D^4 \times L = \frac{\pi \times 7.8 \times 10^{-3}}{8} \times 4^4 \times 130 = 101.9 \text{ (kgf} \cdot \text{cm}^2)$$

b. Moving parts:

$$GD_w^2 = W \left(\frac{l}{\pi} \right)^2 = (1100+800) \times \left(\frac{1.0}{\pi} \right)^2 = 192.5 \text{ (kgf} \cdot \text{cm}^2)$$

c. Coupling:

$$GD_j^2 = 40 \text{ (kgf} \cdot \text{cm}^2)$$

d. Total of inertial:

$$GD_L^2 = GD_s^2 + GD_w^2 + GD_j^2 = 334.4 \text{ (kgf} \cdot \text{cm}^2)$$

• Driving torque

In this case, the time sharing of machine working at acceleration condition is limited. Assuming the machine works at constant speed, the torque caused by angular acceleration is then neglected.

a. Preloading torque:

$$T_P = k \times \frac{F_{ao} \times l}{2\pi} = 0.18 \times \frac{380 \times 1.0}{2\pi} = 10.8 \text{ (kgf} \cdot \text{cm)}$$

$$k = 0.18$$

$$F_{ao} = F_{max}/3$$

b. Friction torque

Rapid feed:

$$T_a = \frac{F_a \times l}{2\pi \times \eta} = \frac{190 \times 1.0}{2\pi \times 0.9} = 33.6 \text{ (kgf} \cdot \text{cm)}$$

Light cutting:

$$T_b = \frac{690 \times 1.0}{2\pi \times 0.9} = 122.1 \text{ (kgf} \cdot \text{cm)}$$

Heavy cutting:

$$T_c = \frac{1140 \times 1.0}{2\pi \times 0.9} = 201.7 \text{ (kgf} \cdot \text{cm)}$$

The maximum required driving torque is preloading torque plus friction torque of heavy cutting.

$$\begin{aligned} T_L &= T_P + T_c \\ &= 212.5 \text{ (kgf} \cdot \text{cm)} \end{aligned}$$

• Selecting driving motor

<Selecting conditions>

a. The highest rotation speed: $N_{max} \geq 1500 \text{ (rpm)}$ b. Rated torque: $T_M > T_L$ c. Rotor inertia: $J_M \geq J_L / 3$

The specifications required for driving motor are then decided as per above conditions.

© Motor specifications:

Output	$W_M = 3.6 \text{ (kW)}$
Highest rotation speeds	$N_{max} = 1500 \text{ (rpm)}$
Rated torque	$T_M = 22.6 \text{ (N} \cdot \text{m)}$
Rotor inertia	$GD_M^2 = 750 \text{ (kgf} \cdot \text{cm}^2)$

- Check required time period for reaching highest rotation speed

$$t_a = \frac{J}{T'_M - T_L} \times \frac{2\pi N}{60} \times f$$

Here

$$J : \text{Total inertia} \quad J = \frac{GD^2}{4g}$$

$$T'_M = 2 \times T_M$$

T_L : Rotation Torque (rapid)

f : Safe factor (choose 1.4 for this case)

$$t_a = \frac{(334.3+750)}{4 \times 980 \times (2 \times 230 - (18.1+33.6))} \times \frac{2\pi \times 1400}{60} \times 1.4 = 0.139 \text{ (sec)} < 0.15 \text{ (sec)}$$

This above motor specifications match design needs.

Calculating the stress of the Ballscrew

$$\sigma = \frac{F}{A} = \frac{F_{max}}{\pi dr^2/4} = \frac{1140 \times 9.8 \times 4}{\pi \times 35.05^2} = 11.56 \text{ N/mm}^2 = 1.16 \times 10^7 \text{ N/m}^2$$

(dr is screw shaft thread root diameter)

$$dr = 40 + 1.4 - 6.35 = 35.05 \text{ (mm)}$$

$$\tau = \frac{T \times r}{J} = \frac{21540 \times 20}{148167} = 2.91 \text{ N/mm}^2 = 2.91 \times 10^6 \text{ N/m}^2$$

$$T_{max} = T_L = 219.8 \text{ (kgf}\cdot\text{cm)} = 21540 \text{ (N}\cdot\text{mm)}$$

$$J = \frac{\pi dr^4}{32} = \frac{\pi (35.05^4)}{32} = 148167 \text{ (mm}^4\text{)}$$

$$\begin{aligned} \sigma_{max} &= \sqrt{\sigma^2 + \tau^2} \\ &= 11.9 \times 10^6 \text{ N/m}^2 \end{aligned}$$

50CrMo4 steel tension strength is $1.1 \times 10^8 \text{ N/m}^2 > \sigma_{max}$
Yield strength is $0.9 \times 10^8 \text{ N/m}^2 > \sigma_{max}$

◎So the Ballscrew selected is safe.

Calculating the buckling load of the screw shaft

$$P = \alpha \frac{\pi^2 nEI}{L^2} = m \frac{dr^4}{L^2} \times 10^3 = 20.3 \times \frac{35.05^4}{1100^2} \times 10^3 = 25300 \text{ (kgf)} > F_{max} \text{ (1140 kgf)}$$

◎So the Ballscrew selected is safe.

High Speed Porterage Apparatus (Horizontal application)

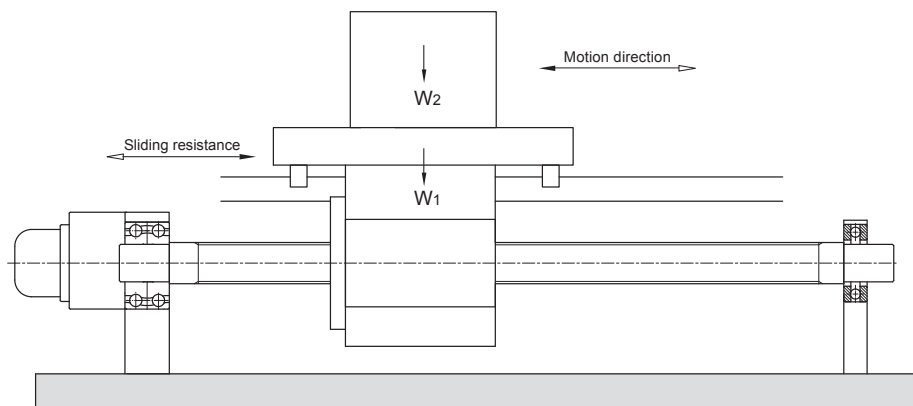

Fig.34 High speed porterage apparatus

Design Conditions

Table weight:	$W_1 = 50 \text{ kg}$
Work piece weight:	$W_2 = 25 \text{ kg}$
Max. travel:	$S_{max} = 1000 \text{ mm}$
Rapid feed speed:	$V_{max} = 50 \text{ m/min}$
Life:	$L_f = 25000 \text{ hours}$
Guiding surface friction coefficient:	$\mu = 0.01$
Driving motor:	$N_{max} = 3000 \text{ rpm}$
Positioning Accuracy:	$\pm 0.10/\text{at max. travel}$
Repeatability Accuracy:	$\pm 0.01 \text{ mm}$

Motion Conditions

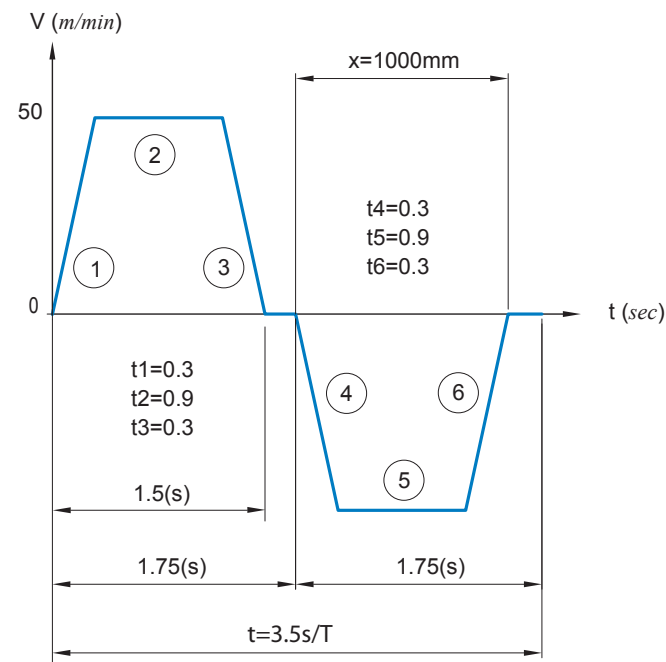

Fig.35 Porterage apparatus v-t diagram

Items to be decided

- Screw nominal O.D., Lead
- Accuracy grade
- Type of nut
- Driving motor

Selecting Screw nominal O.D., Lead

- Lead (l)

The highest rotation speed of motor

$$l \geq \frac{V_{max}}{N_{max}} = \frac{50000}{3000} \approx 17 \text{ (mm)}$$

☉Lead have to be 18 mm or more.

(As per PMI catalog : select 20 mm for further analysis)

If lead is 20 mm, the highest rapid feed speed 50 m/min shall be reached as long as the motor rotates at 2500 rpm.

- Initial selection of screw shaft length

L = Max. travel + Nut length + Unthreaded area length

$$= 1000 + 100 + 100 = 1200 \text{ (mm)}$$

- Selecting screw shaft diameter

Ballscrew shaft diameter can be decided by critical rotation speed of high speed feed.

Assume the supporting ends are fixed-supported.

So the permissible rotational speed :

$$n = \alpha \times \frac{60\lambda^2}{2\pi L^2} \sqrt{\frac{EIg}{rA}} = f \frac{dr}{L^2} \times 10^7$$

$$\Rightarrow dr \geq \frac{n \times L^2}{f} \times 10^7$$

L = Max. travel + Nut length/2 + Unthread area length

$$= 1000 + 50 + 100 = 1150 \text{ (mm)}$$

Screw shaft support method is fixed-supported

$$f = 15.1$$

$$dr \geq 21.9 \text{ (mm)}$$

If the high rotational speed is 2500 rpm,

Diameter at thread root area must be bigger than 22 mm.

☉So Screw-shaft diameter shall be ranged in between 25 and 36 mm

- Considering service life

First to analyze Fig.35[A1-83] (V-t diagram)

The speed line is a straight one, hence it is a constant acceleration, periodically reciprocating motion.

Maximum velocity : $V_{max} = 50 \text{ (m/min)} = 0.83 \text{ (m/s)}$

Acceleration time : $t_1 = 0.3 \text{ (s)}$

Deceleration time : $t_3 = 0.3 \text{ (s)}$

a. Running distance during acceleration

$$x_1 = \left(\frac{V_0 + V}{2} \right) \times t = \left(\frac{0 + 0.83}{2} \right) \times 0.3$$

$$= 0.125 \text{ (m)} = 125 \text{ (mm)}$$

b. Running distance during constant speed

$$x_2 = V \cdot t = 0.83 \times 0.9$$

$$= 0.75 \text{ (m)} = 750 \text{ (mm)}$$

c. Running distance from highest speed to stop

$$x_3 = \left(\frac{V_0 + V}{2} \right) \times t = \left(\frac{0.83 + 0}{2} \right) \times 0.3 = 0.125 \text{ (m)} = 125 \text{ (mm)}$$

d. The line segment

$$a_1 = \frac{V_{max}}{t_1} = \frac{0.833}{0.3} = 2.8 \text{ (m/s}^2\text{)}$$

$$F_1 = \mu(W_1 + W_2) \times g + (W_1 + W_2) \times a_1 = 0.01 \times (50 + 25) \times 9.8 + (50 + 25) \times 2.8 = 217 \text{ (N)}$$

$$N_1 = n_{max} / 2 = 2500 / 2 = 1250 \text{ (rpm)}$$

e. The line segment

$$F_2 = f \times \mu(W_1 + W_2) \times g = 0.01 \times (50 + 25) \times 9.8 = 7.35 \text{ (N)}$$

$$N_2 = 2500 \text{ (rpm)}$$

f. The line segment

$$F_3 = \mu(W_1 + W_2) \times g + (W_1 + W_2) \times a_3 = 0.01 \times (50 + 25) \times 9.8 + (50 + 25) \times (-2.8) = -203 \text{ (N)}$$

$$N_3 = n_{max} / 2 = 2500 / 2 = 1250 \text{ (rpm)}$$

Whence the relationship between the applied axial load, running distance, time and mean rotation can be as follows:

Motion	Axial load	Running distance	Time	Mean rotation
Acceleration forward	217	125	0.3	1250
Constant speed forward	7.35	750	0.9	2500
Deceleration forward	-203	125	0.3	1250
Acceleration returning	-217	125	0.3	1250
Constant speed returning	-7.35	750	0.9	2500
Deceleration returning	203	125	0.3	1250

g. Calculation of mean load and mean rotation:

$$F_m = \left(\frac{F_1^3 \cdot n_1 \cdot t_1 + F_2^3 \cdot n_2 \cdot t_2 + \dots + F_n^3 \cdot n_n \cdot t_n}{n_1 \cdot t_1 + n_2 \cdot t_2 + \dots + n_n \cdot t_n} \right)^{\frac{1}{3}} = \left(\frac{217^3 \times 1250 \times 0.6 + 7.35^3 \times 2500 \times 1.8 + 203^3 \times 1250 \times 0.6}{1250 \times 0.6 + 2500 \times 1.8 + 1250 \times 0.6} \right)^{\frac{1}{3}}$$

$$= 132.4 \text{ (N)}$$

$$N_m = \frac{n_1 \cdot t_1 + n_2 \cdot t_2 + \dots + n_n \cdot t_n}{t} = \frac{1250 \times 0.6 + 2500 \times 1.8 + 1250 \times 0.6}{3.5} = 1714 \text{ (rpm)}$$

h. Calculation of life

$$L_t = \left(\frac{Ca}{F_m \times f_w} \right)^3 \times \frac{1}{60 N_m} \times 10^6 = \left(\frac{1170 \times 9.8}{132.4 \times 2.5} \right)^3 \times \frac{1}{60 \times 1714} \times 10^6$$

$$= 404000 \geq 25000 \text{ (hours)}$$

©Above conforms design requirements.

Selecting accuracy grade

Positioning accuracy of $\pm 0.1/1000$ mm (Max. travel) From page.A1-6

Accuracy grade: C5

E = $\pm 0.040/1000$

e = 0.027

Selecting Ballscrew type

Considering operation conditions, effective turns of A1 is selected.

Selecting following type:

R25-20A1-FSWE-1000-1160-0.018

Screw-shaft support method is fixed-supported

Selecting driving motor

<Required specifications>

1.The highest rotation speed of 3000 (rpm)

2.Time required to reach highest rotational speed is within 0.30 sec

• Inertial

a. Screw shaft:

$$J_{SH} = \frac{\pi \rho}{32g} \times D^4 \times L = \frac{\pi \times 7.8 \times 10^{-3}}{32 \times 980} \times 2.5^4 \times 120 = 0.0037 \text{ (kgf} \cdot \text{cm} \cdot \text{sec}^2)$$

b. Moving parts:

$$J_w = \frac{W}{g} \left(\frac{l}{2\pi} \right)^2 = \frac{25+50}{980} \left(\frac{2}{2\pi} \right)^2 = 0.0078 \text{ (kgf} \cdot \text{cm} \cdot \text{sec}^2)$$

c. Coupling:

$$J_C = 0.0005 \text{ (kgf} \cdot \text{cm} \cdot \text{sec}^2)$$

d. Total of Inertial:

$$J_L = J_{SH} + J_w + J_C = 0.012 \text{ (kgf} \cdot \text{cm} \cdot \text{sec}^2)$$

• Driving torque

a. During constant speed:

$$T_1 = \frac{F_2 \times l}{2\pi \times \eta} = \frac{7.35 \times 2}{2\pi \times 0.9} = 2.6 \approx 3.00 \text{ (N.cm)}$$

$$\eta = 0.9$$

b. During acceleration

$$T_2 = T_1 + J\dot{\omega} = T_1 + (J_L + J_M) \times \frac{2\pi n}{60 t_1} = 3 + (0.009 + 0.01) \times 9.8 \times \left(\frac{2\pi \times 2500}{60 \times 0.3} \right) = 166 \text{ (N.cm)}$$

preselect motor, and give the specifications for the rate inertia

$$J_M = 0.01 \text{ (kgf.cm.sec}^2\text{)}$$

c. During deceleration

$$T_3 = T_1 - J\dot{\omega} = T_1 - (J_L + J_M) \times \frac{2\pi n}{60 t_3} = 3 - (0.009 + 0.01) \times 9.8 \times \left(\frac{2\pi \times 2500}{60 \times 0.3} \right) = -160 \text{ (N.cm)}$$

• Selecting driving motor

<Selecting conditions>

a. The highest rotation speed: $N_{max} \geq 3000 \text{ (rpm)}$

b. Rated torque ----- $T_M > T_L$

c. Rotor inertia ----- $J_M \geq J_L / 3$

The specifications required for driving motor are then decided as per above conditions.

☉ Motor specifications:

Output	$W_M = 400 \text{ (kW)}$
Highest rotation speeds	$N_{max} = 3000 \text{ (rpm)}$
Rated torque	$T_M = 1.27 \text{ (N.m)}$
Rotor inertia	$J_M = 0.01 \text{ (kgf.cm.sec}^2\text{)}$

• Effective torque:

$$T_{rms} = \sqrt{\frac{T_2^2 \times t_a + T_1^2 \times t_b + T_3^2 \times t_c}{t}} = \sqrt{\frac{166^2 \times 0.6 + 3^2 \times 1.8 + 160^2 \times 0.6}{3.5}} = 95 \text{ (N.cm)} < 127 \text{ (N.cm)}$$

☉ It conforms to design requirements.

• Time required to reach highest rotational speed.

$$t_a = \frac{J}{T_M - T_L} \times \frac{2\pi n}{60} \times f$$

Here:

J : Total inertia

$$T_M' = 2 \times T_M$$

T_L : Rotation Torque (rapid)

f : Safe factor (choose 1.4 for this case)

$$t_a = \frac{0.009 + 0.01}{2 \times 127 \times 3} \times 9.8 \times \frac{2\pi \times 2500}{60} \times 1.4 = 0.27 \text{ (s)} < 0.3 \text{ (s)}$$

☉ It conforms to design requirements.

Calculating the stress of the Ballscrew

$$\sigma = \frac{F}{A} = \frac{F_{max}}{\pi d r^2 / 4} = \frac{217 \times 4}{\pi \times 22.425^2} = 0.61 \text{ N/mm}^2 = 6.1 \times 10^5 \text{ N/m}^2$$

$$dr = 25 + 1.4 \cdot 762 = 21.238 \text{ (mm)}$$

(dr is screw shaft thread minor diameter)

$$\tau = \frac{T \times r}{J} = \frac{1660 \times 12.5}{24827} = 0.84 \text{ N/mm}^2 = 8.4 \times 10^5 \text{ N/m}^2$$

$$T_{max} = T_L = 166 \text{ (N.cm)} = 1660 \text{ (N.mm)}$$

$$J = \frac{\pi d r^4}{32} = \frac{\pi (22.425^4)}{32} = 24827 \text{ (mm}^4\text{)}$$

$$\sigma_{max} = \sqrt{\sigma^2 + \tau^2} = 0.10 \times 10^8 \text{ N/m}^2$$

50CrMo4 steel tension strength is $1.5 \times 10^8 \text{ N/m}^2$

Yield strength is $0.9 \times 10^8 \text{ N/m}^2$

☉ So the Ballscrew selected is safe.

Calculating the buckling load of the screw shaft

$$P = \alpha \frac{\pi^2 nEI}{L^2} = m \frac{dr^4}{L^2} \times 10^3$$

$$= 10.2 \times \frac{22.425^4}{1160^2} \times 10^3$$

$$= 1917 \text{ (kgf)} > F_{max} (22.14 \text{ kgf})$$

☉ So the Ballscrew selected is safe.

Vertical Porterage Apparatus

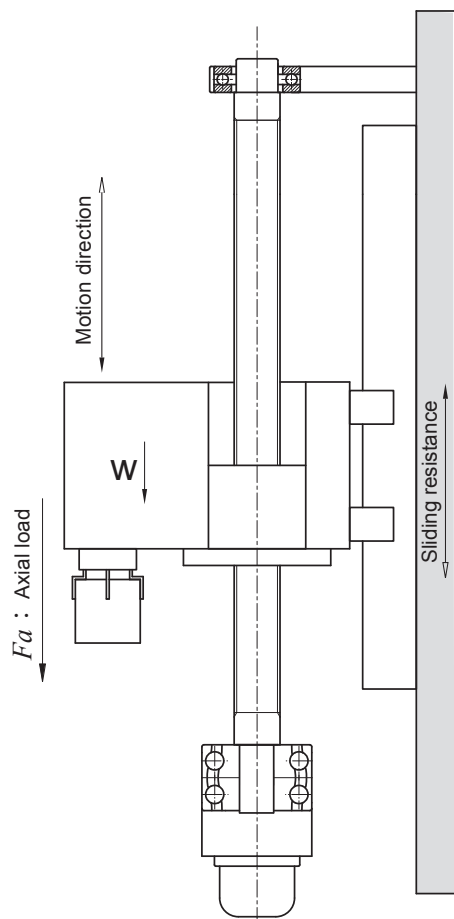

Fig.36 Vertical porterage apparatus

Design Conditions

Table weight:	$W_1 = 300 \text{ kg}$
Work piece weight:	$W_2 = 50 \text{ kg}$
Max. travel:	$S_{max} = 1500 \text{ mm}$
Rapid feed speed:	$V_{max} = 15 \times 10^3 \text{ mm/min}$
Life:	$Lt = 20000 \text{ hours}$
Guiding surface friction coefficient:	$\mu = 0.01$
Driving motor:	$N_{max} = 1500 \text{ rpm}$
Positioning accuracy:	$\pm 0.8/1500 \text{ mm}$
Repeatability accuracy:	$\pm 0.3 \text{ mm}$

Motion Conditions

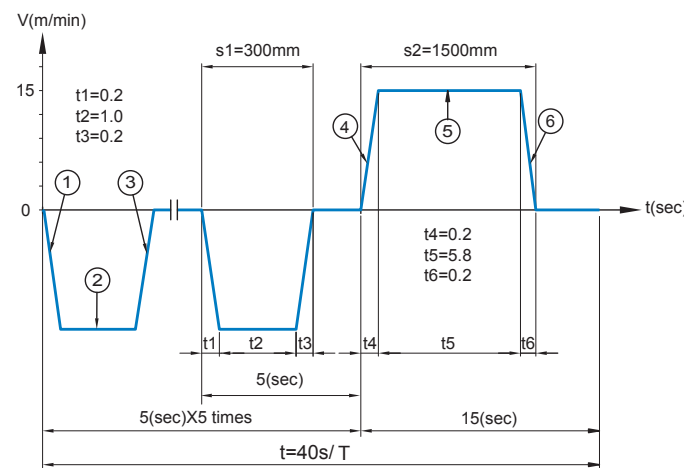

Fig.37 Porterage apparatus v-t diagram

Items to be decided:

- Accuracy grade
- Screw nominal O.D., Lead
- Driving motor

Selecting accuracy grades

As per design condition: positioning accuracy required: 0.8/1500 mm

$$\frac{\pm 0.8}{1500} = \frac{\pm 0.16}{300}$$

Refer to **Table 2[A1-6]**, accumulated reference lead deviation ($\pm E$) and total relative variation (e)

Accuracy grades C7

$E = \pm 0.05/300$ mm

☉ So the portage apparatus can use Rolled Ballscrew.

Selecting screw nominal O.D., Lead

- Lead (l) :

The highest rotation speed of motor

$$l \cong \frac{V_{max}}{N_{max}} = \frac{15000}{1500} = 10 \text{ (mm)}$$

☉ Lead have to be 10 mm or more.

(As per **PMI** catalog : select 10 mm for further analysis)

- Permissible axial load

Setting up is positive.

a. Force during acceleration (downward)

$$a_1 = \frac{V_{max}}{t_1} = \frac{15000}{60 \times 0.2} = 1250 \text{ (mm/s}^2\text{)} = 1.25 \text{ (m/s}^2\text{)}$$

$$f = \mu (W_1 + W_2) \times g = 0.01(300 + 50) \times 9.8 = 35 \text{ (N)} \text{ (Friction)}$$

$$F = ma \rightarrow F_1 = (W_1 + W_2) \times g - f - (W_1 + W_2) \times a_1 = 2958 \text{ (N)}$$

b. Force during constant speed (downward)

$$F = 0 \rightarrow F_2 = (W_1 + W_2) \times g - f = 3395 \text{ (N)}$$

c. Force during deceleration (downward)

$$F = ma \rightarrow F_3 = (W_1 + W_2) \times g - f + (W_1 + W_2) \times a_3 = 3833 \text{ (N)}$$

d. Force during acceleration (upward)

$$F = ma \rightarrow F_4 = (W_1 + W_2) \times g + f + (W_1 + W_2) \times a_4 = 3903 \text{ (N)}$$

e. Force during constant speed (upward)

$$F = 0 \rightarrow F_5 = (W_1 + W_2) \times g + f = 3465 \text{ (N)}$$

f. Force during deceleration (upward)

$$F = ma \rightarrow F_6 = (W_1 + W_2) \times g + f - (W_1 + W_2) \times a_6 = 3028 \text{ (N)}$$

So

$$F_{a_{max}} = F_4 = 3903 \text{ (N)}$$

- Buckling load:

$$P = \alpha \frac{\pi^2 nEI}{L^2} = m \frac{dr^4}{L^2} \times 10^3$$

$$dr = \left(\frac{P \times L^2}{m} \times 10^{-3} \right)^{1/4} = \left(\frac{3903 \times 1800^2}{9.8 \times 10.2} \times 10^{-3} \right)^{1/4}$$

$$= 19 \text{ (mm)}$$

Screw shaft diameter at thread root area must be bigger than 19 mm.

☉ So screw shaft diameter shall be ranged in between 25 and 50 mm.

- The length of screw shaft

$L = \text{Max. travel} + \text{Nut length} + \text{Unthreaded area length}$

$$= 1500 + 100 + 200 = 1800 \text{ (mm)}$$

Slenderness ratio: 60 or less

$$D \cong \frac{L}{60} = \frac{1800}{60} = 30 \text{ (mm)}$$

☉ So screw shaft diameter shall be ranged in between 32 and 50 mm.

- Permissible rotational speed

Assume the supporting ends are fixed-supported

So the permissible rotational speed:

$$n = \alpha \times \frac{60\lambda^2}{2\pi L^2} \sqrt{\frac{EIg}{\gamma A}} = f \frac{dr}{L^2} \times 10^7$$

$$\Rightarrow dr \geq \frac{n \times L^2}{f} \times 10^{-7} \quad (f=15.1, L=1800)$$

$$\geq 30$$

If the highest rotational speed reaches 1500 rpm, screw shaft thread diameter at thread root area must be bigger than 30 mm.

☉ So screw shaft diameter shall be ranged in between 36 and 50 mm.

- Calculating of basic dynamic rate load:

Motion	Axial load (N)	Mean rotation (rpm)	Time (sec)
Acceleration (down)	$F_1=2958$	$n_1=750$	$t_1=1.0$
Constant speed (down)	$F_2=3395$	$n_2=1500$	$t_2=5.0$
Deceleration (down)	$F_3=3833$	$n_3=750$	$t_3=1.0$
Acceleration (up)	$F_4=3903$	$n_4=750$	$t_4=0.2$
Constant speed (up)	$F_5=3465$	$n_5=1500$	$t_5=5.8$
Deceleration (up)	$F_6=3028$	$n_6=750$	$t_6=0.2$

Mean load

$$F_m = \left(\frac{F_1^3 \cdot n_1 \cdot t_1 + F_2^3 \cdot n_2 \cdot t_2 + \dots + F_n^3 \cdot n_n \cdot t_n}{n_1 \cdot t_1 + n_2 \cdot t_2 + \dots + n_n \cdot t_n} \right)^{\frac{1}{3}} = 3436 \text{ (N)}$$

Mean rotation

$$N_m = \frac{n_1 \cdot t_1 + n_2 \cdot t_2 + \dots + n_n \cdot t_n}{t} = 450 \text{ (rpm)}$$

As per design condition:

Life required is 20000 hours, Let $f_w=1.2$

$$L_t = \left(\frac{Ca}{F_m \times f_w} \right)^3 \times \frac{1}{60N_m} \times 10^6$$

$$Ca = (60N_m \times L_t)^{\frac{1}{3}} \times F_m \times f_w \times 10^{-2} = 33576 \text{ (N)} = 3426 \text{ (kgf)}$$

☉ If the life required is > 20000 (hours),

Ca has to be > 3426 (kgf)

- Calculating basic static rate load:

$$Co = F_{max} \times f_s \quad f_s = 2.0$$

$$= 7806 \text{ (N)}$$

$$= 800 \text{ (kgf)}$$

Co has to be > 800 (kgf)

☉ Selection is made as follows:

Type of the Ballscrew: 40-10B2-FSWW

Screw shaft diameter: 40 (mm)

Lead: 10 (mm)

Basic dynamic rate load: 3520 (kgf)

Selecting driving motor

<Required specifications>

The highest rotation speeds is 1500 mm/min

Time required to reach highest rotational speed is within 0.2 sec.

- Inertial

a. Screw shaft:

$$GD_s^2 = \frac{\pi \rho}{32} \times D^4 \times L = \frac{\pi \times 7.8 \times 10^{-3}}{32} \times 4^4 \times 180 = 35.29 \text{ (kgf} \cdot \text{cm}^2)$$

b. Moving parts:

$$GD_w^2 = W \left(\frac{l}{\pi} \right)^2 = (300+50) \times \left(\frac{1.0}{\pi} \right)^2 = 192.5 \text{ (kgf} \cdot \text{cm}^2)$$

c. Coupling:

$$GD_j^2 = 1.0 \text{ (kgf} \cdot \text{cm}^2)$$

d. Total of Inertial:

$$GD_L^2 = GD_s^2 + GD_w^2 + GD_j^2 = 228.79 \text{ (kgf} \cdot \text{cm}^2)$$

• Driving torque:

(1)Friction torque

a.Acceleration (downward):

$$T_1 = \frac{Fa \times l}{2\pi \times \eta} = \frac{2950 \times 1.0}{2\pi \times 0.9} = 520 \text{ (N}\cdot\text{cm)}$$

b.Constant speed (downward):

$$T_2 = \frac{Fa \times l}{2\pi \times \eta} = \frac{3395 \times 1.0}{2\pi \times 0.9} = 600 \text{ (N}\cdot\text{cm)}$$

c.Deceleration (downward):

$$T_3 = \frac{Fa \times l}{2\pi \times \eta} = \frac{3833 \times 1.0}{2\pi \times 0.9} = 680 \text{ (N}\cdot\text{cm)}$$

d.Acceleration (upward):

$$T_4 = 690 \text{ (N}\cdot\text{cm)}$$

e.Constant speed (upward):

$$T_5 = 610 \text{ (N}\cdot\text{cm)}$$

f.Deceleration (upward):

$$T_6 = 540 \text{ (N}\cdot\text{cm)}$$

(2)Preloading torque

No preload is applied to the roller ballscrew, so the preload torque is zero.

(3)Torque required for acceleration:

$$T_7 = J \cdot \omega$$

$$= (J_L + J_M) \times \frac{2\pi n}{60 t_i} = \frac{(228.79 + 120)}{980} \times \left(\frac{2\pi \times 1500}{60 \times 0.2} \right) = 279.53 \text{ (kgf}\cdot\text{cm)} = 2739 \text{ (N}\cdot\text{cm)}$$

First select motor's specification

$$GD_M = 120 \text{ (kgf}\cdot\text{cm}^2)$$

(4)Total torque:

a.Acceleration (downward):

$$T_{k1} = T_1 + T_7 = 520 + 2739 = 3259 \text{ (N}\cdot\text{cm)}$$

b.Constant speed (downward):

$$T_{l1} = T_2 = 600 \text{ (N}\cdot\text{cm)}$$

c.Deceleration (downward):

$$T_{g1} = T_3 + T_7 = 680 + 2739 = 3419 \text{ (N}\cdot\text{cm)}$$

d.Acceleration (upward):

$$T_{k2} = T_4 + T_7 = 690 + 2739 = 3429 \text{ (N}\cdot\text{cm)}$$

e.Constant speed (upward):

$$T_{l2} = T_5 = 610 \text{ (N}\cdot\text{cm)}$$

f.Deceleration (upward):

$$T_{g2} = T_6 + T_7 = 540 + 2739 = 3279 \text{ (N}\cdot\text{cm)}$$

The maximum torque takes place at the time of acceleration.

$$T_{max} = T_{k2} = 3429 \text{ (N}\cdot\text{cm)}$$

- Selecting driving motor

<Selecting conditions>

a. The highest rotation speeds: $N_{max} \geq 1500$ (rpm)

b. Rated torque: $T_M = T_{rms}$

c. Rotor inertia: $J_M \geq J_L/3$

The specifications required for driving motor are then decided as per above conditions

◎ Motor specifications:

Output	$W_M = 2000$ (W)
Highest rotation speeds	$N_{max} = 1500$ (rpm)
Rated torque	$T_M = 20$ (N.m)
Rotor inertia	$GD_M^2 = 120$ (kgf.cm ²)

- Effective torque:

$$T_{rms} = \sqrt{\frac{T_{k1}^2 \times t_1 + T_{i1}^2 \times t_2 + T_{g1}^2 \times t_3 + T_{k2}^2 \times t_4 + T_{i2}^2 \times t_5 + T_{g2}^2 \times t_6}{t}}$$

$$= \sqrt{\frac{3259^2 \times 1.0 + 600^2 \times 5 + 3419^2 \times 1 + 3429^2 \times 0.2 + 610^2 \times 5.8 + 3279^2 \times 0.2}{20}}$$

$$= 607.93 \text{ (N-cm)} < 2000 \text{ (N-cm)}$$

◎ It conforms to design requirements.

Calculating the stress of the Ballscrew

$$\sigma = \frac{F}{A} = \frac{F_{max}}{\pi dr^2/4}$$

$$= \frac{3903 \times 9.8 \times 4}{\pi \times 35.05^2}$$

$$= 4.04 \text{ N/mm}^2$$

$$= 4.04 \times 10^6 \text{ N/m}^2$$

$$\tau = \frac{T \times r}{J}$$

$$= \frac{34290 \times 20}{148167}$$

$$= 4.63 \text{ N/mm}^2$$

$$= 4.63 \times 10^6 \text{ N/m}^2$$

$$\sigma_{max} = \sqrt{\sigma^2 + \tau^2}$$

$$= 6.14 \times 10^6 \text{ N/m}^2$$

$$dr = 40 + 1.4 - 6.35 = 35.05 \text{ (mm)}$$

(dr is screw shaft thread root diameter)

$$T_{max} = T_L = 3429 \text{ (N-cm)} = 34290 \text{ (N-mm)}$$

$$J = \frac{\pi dr^4}{32} = \frac{\pi (35.05^4)}{32} = 148167 \text{ (mm}^4\text{)}$$

50CrMo4 steel tension strength is $1.1 \times 10^8 \text{ N/m}^2$

Yield strength is $0.9 \times 10^8 \text{ N/m}^2$

◎ So the Ballscrew selected is safe.

Calculating the buckling load of the screw shaft

$$P = \alpha \frac{\pi^2 nEI}{L^2} = m \frac{dr^4}{L^2} \times 10^3$$

$$= 10.2 \times \frac{35.05^4}{1800^2} \times 10^3$$

$$= 4751 \text{ (kgf)} > F_{max} \text{ (398 kgf)}$$

◎ So the Ballscrew selected is safe.

PMI Ballscrew Cooling System

PMI's design of hollow cooling system is especially good for high speed Ballscrews. It shall well dissipate heat generated by friction between balls and grooves during Ballscrew running, and then to minimize thermal deformation as to ensure positioning accuracy.

Introduction to Hollow Cooling Screw Shaft

The hollow cooling system is designed by PMI (Fig.38) It uses a coolant pipe through the hollow hole of Ballscrew. The hollow hole is through all of the Ballscrew, and one end is clogged with the oil seal. The coolant is pumped into coolant pipe and flow to the end of coolant pipe. Coolant then flow reversely along the hollow hole back into the coolant collector. It can cool down the Ballscrew. The coolant is then sucked back to the cooling unit to drop coolant temperature and pumped again to the coolant pipe to complete circulation.

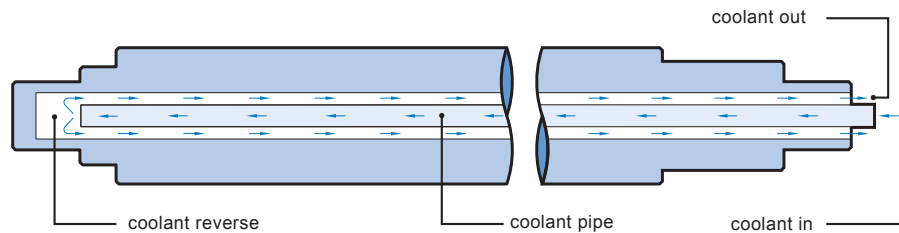

Fig.38 Hollow cooling diagram

Hollow Cooling Screw Shaft Related Introduction

Hollow cooling system

Features:

- (1) Well and effectively control Ballscrew thermal expansion.
- (2) Simple design and structure to save cost.

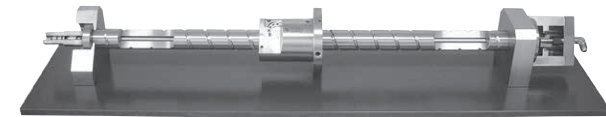

Fig.39 Hollow cooling system

Cooling entrance

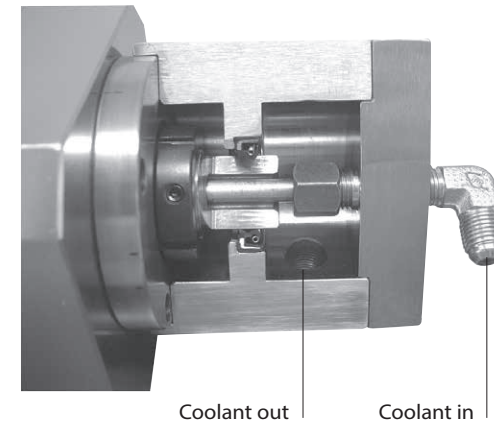

Fig.40 Cooling entrance

End sealing

Features: Easy for installing, disassembling and maintenance.

Coolant pipe support installation

Supported the coolant pipe. Let it don't touch Ballscrew.

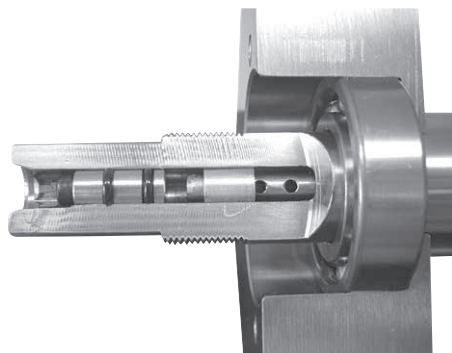

Fig.41 End sealing structure

Thermal control experiment

Test condition

Screw nominal O.D. : $\varnothing 40\text{ mm}$
 Lead: 10 mm
 Rotation speed: 1000 min^{-1}
 Speed: 10 m/min
 Load: 400 kgf
 Slideways: Box ways

The results of experiment

As per the results by experiment, *PMI*'s design of hollow cooling system proves an effective way for controlling the thermal expansion on the Ballscrew. Hence it is a very helpful design to high precision machine tools.

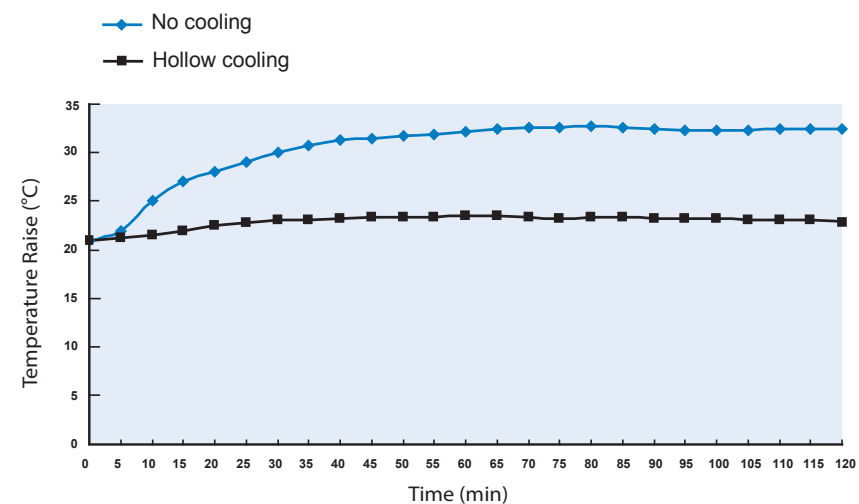

Fig.42 The results of experiment

Nut Cooling

The principle of design

Cool liquid is able to control the heat generation and thermal expansion by creating circulating cooling channel in the nut.

Type A - Recirculation Type Cooling

Single Nut Cooling

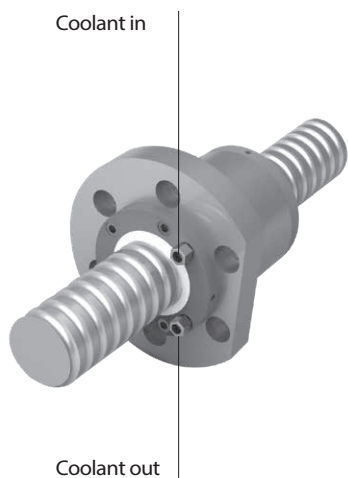

Double Nut Cooling

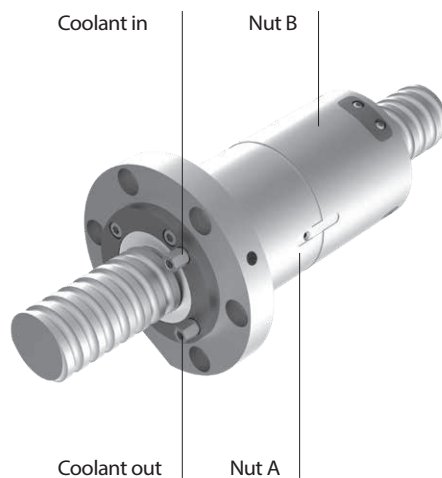

Fig.43 Single nut cooling and Double nut cooling diagram

Table 21 Recirculation type cooling nut- Testing Parameters

Model no.	R45-12T5-FDDA-1274-1569-0.018
Operation travel(mm)	690
Feed speed(m/min)	7.2
Mean rotation (rpm)	523.3
Acceleration (m/s ²)	5
Preload (kgf)	392
Table weight (kgf)	200
Mounting method	fixed-supported
Coolant	Mobil Velocite oil no.3 (ISO VG 2)
Coolant flow (L/min)	3.1
Coolant Temperature (°C)	Room temperature ±0.5

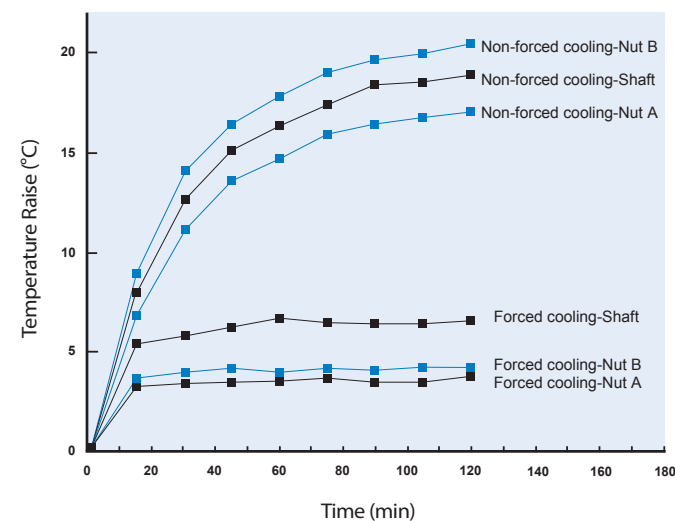

Fig.44 The results of experiment

Type B - Direct Passing Type Cooling

Cooling liquid at the same time enter the cooling channel of nut by direct passing, it's better cooling rate than recirculation channel type.

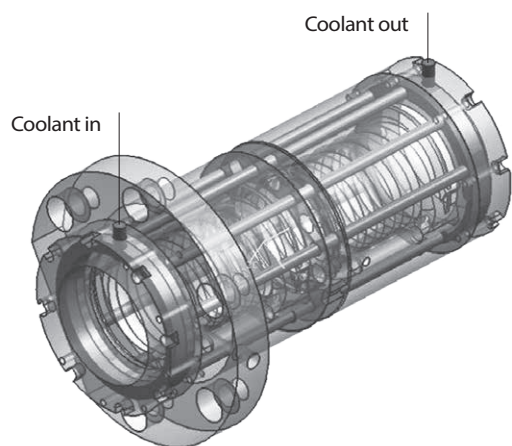

Fig.45 Direct passing type

Characteristics

Increase the positioning accuracy and the stability

Control the temperature rise of the ballscrew and reduced the heat deformation. The high velocity and accuracy of the machine will be reached.

Decrease the warm-up time of machine

The stable temperature of the ballscrew be quickly, so the warm-up time of the machine could be shortened.

Maintain capability of the lubrication oil

When the temperature of the ballscrew is stabilized, it is able to avoid the deterioration of the lubrication caused by high temperature.

Table 22 Recirculation type and Direct passing type cooling nut-Testing Parameters (FDDDB type has 3 coolant inlets)

Model no.	R45-12T5-FDDA-1274-1569-0.018 R45-12T5-FDDB-1274-1569-0.018
Operation travel(mm)	690
Feed speed(m/min)	7.2
Mean rotation (rpm)	550
Acceleration (m/s ²)	5
Preload (kgf)	392
Table weight (kgf)	250
Mounting method	fixed-supported
Coolant	Mobil Velocite oil no.3 (ISO VG 2)
Coolant flow (L/min)	3.1
Coolant Temperature (°C)	Room temperature ±0.5°C

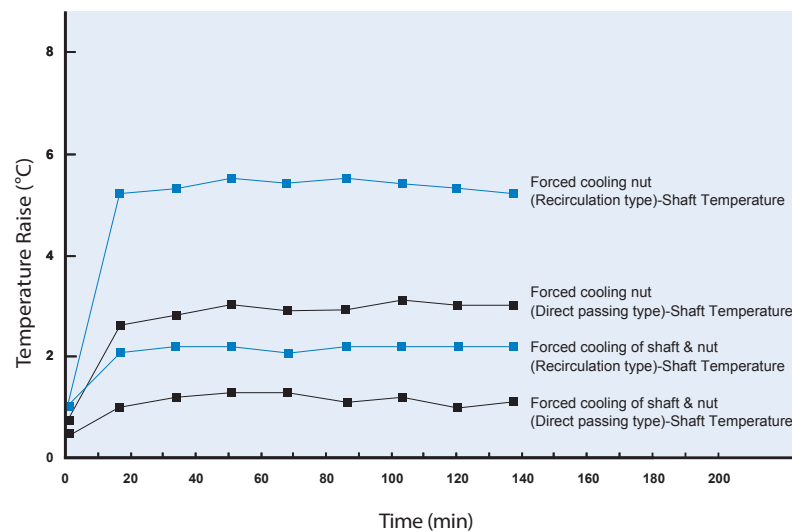

Fig.46 Recirculation type & Direct passing type Comparison

Nomenclature

Example: R45-12T5-FDDA-700-800-0.008

A (Recirculation type cooling)

B (Direct passing type cooling)

Cooling Nut Applications

CNC Machine / Precision Machine / High Speed Machine / Medical equipment

Ball screw of High Dustproof

The ballscrew which is applied to particular environment is easily affected by foreign matters like metal and wood dust intruding inside the screw and affecting the lifetime. In order to prevent from this, high dust-proof series accessories are designed. The special groove design of ballscrew can make the internal dust-proof and sealed washer of wiper fully attached the surface of whorl, and achieves the double effect of dust-free and dust-proof.

As the ballscrews comes with specially designed grooves, the highly dustproof seal washer inside the scraper perfectly matches the threads, a feature that ensures the removal of scraps as well as insulation dust.

Type A2 : Rubber Seal

Wiper specially developed for ball screws, with a multi-layered contact lips structure that ensures effective dust removal, the contact Gothic arch thread of bulgy shape and the lips interference outside diameter of screw shaft, so the dust can't entry inside of nut. As the ballscrews comes with specially designed grooves, the highly dustproof seal washer inside the scraper perfectly matches the threads, a feature that ensures the removal of scraps as well as insulation dust.

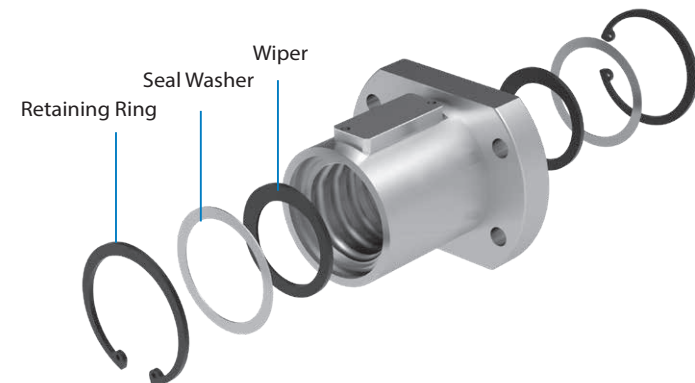

Fig.47 Assembly of rubber seal

Table 23 High dustproof Test Conditions

Specifications	R40-10-FSVE
Running Stroke	300 mm (per cycle)
Motor Speed	150 rpm
Test Environment	Sawdust automatic circulation system

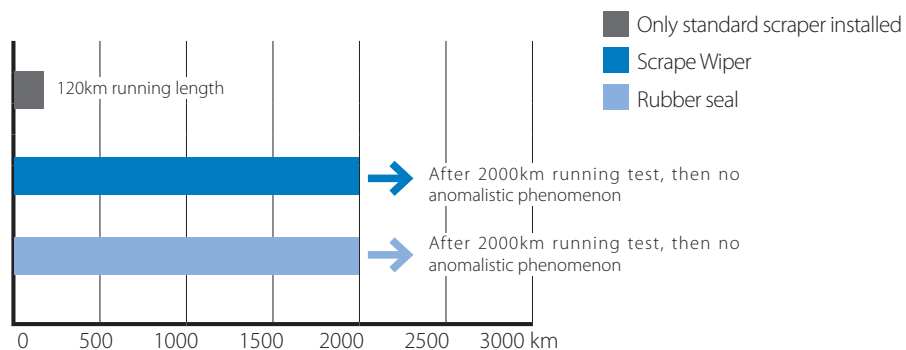

Fig.48 Dustproof performance Comparison

Type A3: Film Seal

The dustproof seals develop focus on general tool machine industrial that doesn't obviously increase of preload torque and temperature rise. Inhibit the grease leakage and scattering achieve cleaner operating environment. Provide the kind of seals that have better strength, service life and prevent fine dust or metal bit into the nut.

Heat generates and preload torque

The preload torque increase only 1~2 kgf-cm with film seals for ballscrew. Compare with non contact wiper, the suppression temperature rise at 1.5~2°C

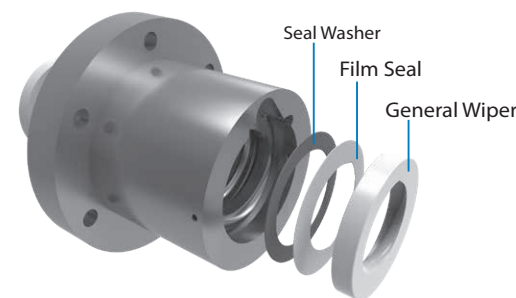

Fig.49 Assembly of a Film seal

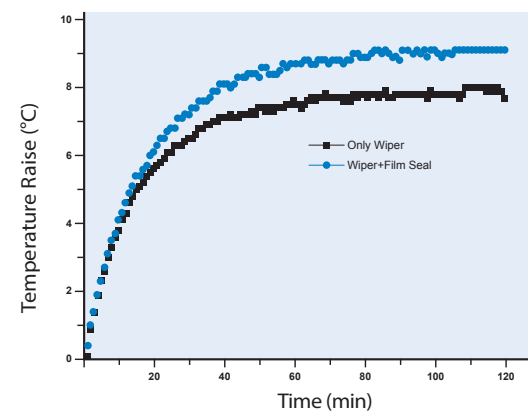

Fig.50 Heat generation comparison

Nomenclature

Example: R 32-10 B2-FSVE-600-700-0.008 A2

A2 (Precision Grade + Rubber Seal),

A3 (Precision Grade + Film Seal)

B2 (Rolled Grade+ Rubber seal type),

B3 (Rolled grade + Film Seal)

Application of High Dustproof Ballscrew

Woodworking machine, laser processing machines, high accuracy transportation equipment, mechanical arms, and other machines that require a dustproof environment.

Spacer Ball Screw

Structure and Features

The Ball Screw with the Spacer eliminates collision and friction between balls and increases the grease retention. This makes it possible to achieve a low noise, extends the lubrication maintenance interval and outstanding sliding.

Features

Low Noise, Soft Noise Tone and High Accuracy

With Spacer can avoid the interference sound among balls. And due to non-mutual friction thus increase heat generation, keep the accuracy in the range.

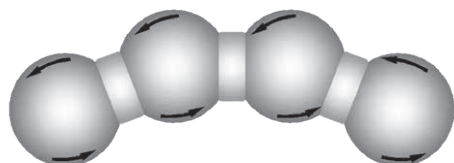

Extend the Maintenance Interval

The friction between the balls has been eliminated; the oil storage grooves design of Spacer and grease retention has been improved, the long-term maintenance-free operation is achieved.

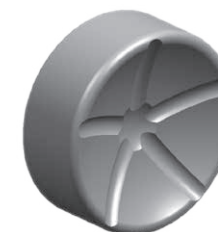

Smooth Motion

The use of a Spacer eliminates the friction between the balls, improves the torque feature, minimizes the torque fluctuation, and keeps constant speed during low-speed, thus high positioning accuracy to be achieved.

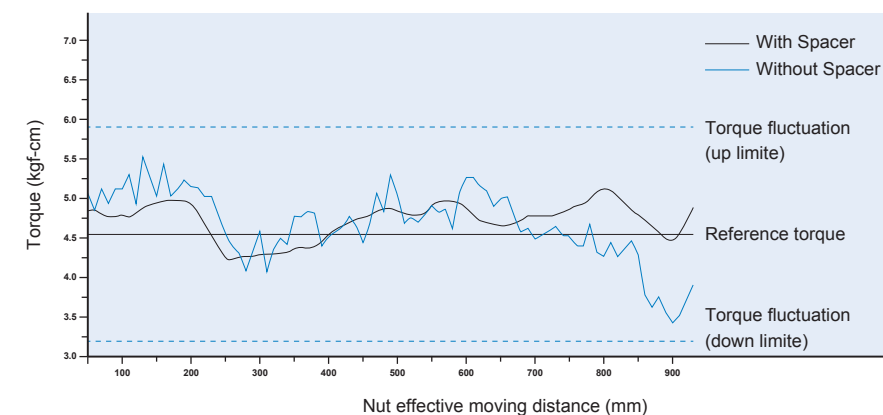

Self-Lubricant Unit-Q Lubricator

PMI lubricator unit is designed with an oil reservoir which equipped with a high-density fiber net. The lubricator feeds the right amount of lubricant to the raceway on the ballscrew. This allows an oil film to continuously be formed between the steel balls and the raceway, and drastically extends the lubrication and maintenance intervals.

Construction

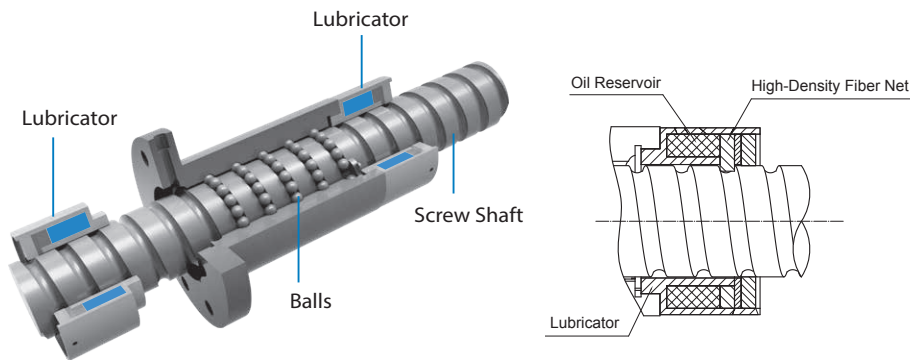

Features

Contrary to the oil losing problem caused by ordinary lubrication, the Q lubricator effectively and evenly distributes adequate amount of oil onto ball raceway during the movement.

- Lengthening the maintenance intervals
- Environmentally Friendly
- Without the installation of other lubricating device, the cost of overall equipment cost is reduce.

Fits the Following Type of Nuts

Internal Ball Circulation Nuts, External Ball Circulation Nuts, End Deflector Series

PMI Precision Ground BallScrew

Internal Ball Circulation Nuts

Features

The advantage of internal ball circulation nut is that the outer diameter is smaller than that of external ball circulation nut. Hence it is suitable for the machine with limit space for Ballscrew installation.

It is strictly required that there is at least one end of screw shaft with complete threads [A1-29] Also the rest area next to this complete thread must be with smaller diameter than the nominal diameter of the screw shaft. Above are required for easy assembling the ballnut onto the screw shaft.

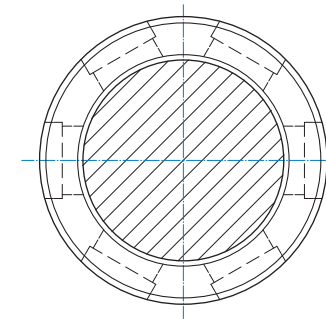
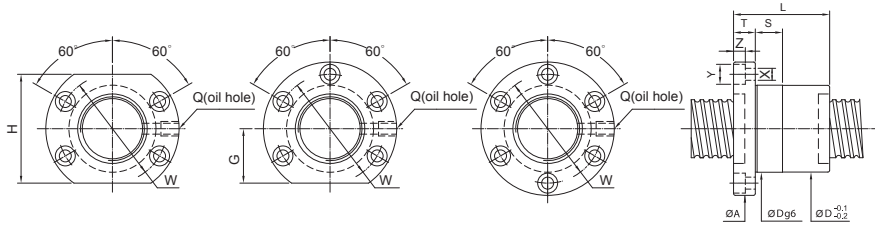

Fig.1 Internal ball circulation's side view

FSIC



Unit:mm

SCREW SIZE	BALL DIA.	EFFECTIVE TURNS	BASIC RATE LOAD (kgf)		NUT		FLANGE					FIT		BOLT			OIL HOLE	STIFFNESS kgf/μm
			Dynamic (1×10 ⁶ REV.) Ca	Static Co	Dg6	L	A	T	W	G	H	S	X	Y	Z	Q		
14	3	2	3	260	460	26	37	46	10	36	-	-	10	4.5	8	4.5	M6×1P	13
	4	2.381	3	420	805	26	42	46	10	36	20	40	10	4.5	8	4.5	M6×1P	14
		2.778	4	840	1870	26	47	46	10	36	20	40	10	4.5	8	4.5	M6×1P	21
5	3.175	3	720	1010	26	42	46	10	36	20	40	10	4.5	8	4.5	M6×1P	16	
16	4	2.381	3	435	920	28	42	48.5	10	39	20	40	10	4.5	8	4.5	M6×1P	16
	5	3.175	3	765	1240	30	42	49	10	39	20	40	10	4.5	8	4.5	M6×1P	18
			4	980	1650	30	49	49	10	39	20	40	10	4.5	8	4.5	M6×1P	23
6	3.175	4	980	1650	30	55	54	12	40	20	40	12	5.5	9.5	5.5	M6×1P	23	
20	4	2.381	4	600	1530	34	44	60	12	48	22	44	12	5.5	9.5	5.5	M6×1P	25
	5	3.175	3	860	1710	47												21
			4	1100	2280	34	53	57	12	45	20	40	12	5.5	9.5	5.5	M6×1P	28
	6	3.969	3	1080	2050	34	53	57	12	45	20	40	12	5.5	9.5	5.5	M6×1P	22
			4	1380	2730	34	61	57	12	45	20	40	12	5.5	9.5	5.5	M6×1P	28
	10	3.175	3	860	1710	36	66	57	12	45	20	40	12	5.5	9.5	5.5	M6×1P	21
25	4	2.381	3	500	1440	40	40	63	12	51	22	44	15	5.5	9.5	5.5	M8×1P	23
			4	980	2300	47												
	5	3.175	4	1250	3070	40	53	63.5	12	51	22	44	15	5.5	9.5	5.5	M8×1P	33
			5	1520	3830	57												
	6	3.969	3	1275	2740	40	53	63.5	12	51	22	44	15	5.5	9.5	5.5	M8×1P	26
			4	1630	3650	40	61	61	12	51	22	44	15	5.5	9.5	5.5	M8×1P	34
	8	3.969	4	1630	3650	40	69	63.5	12	51	22	44	15	5.5	9.5	5.5	M8×1P	34
			5	1970	4560	40	77	77	12	51	22	44	15	5.5	9.5	5.5	M8×1P	43
	10	3.175	3	980	2300	38	70	68	15	55	26	52	15	6.6	11	6.5	M8×1P	26
4			1250	3070	38	81	81	15	55	26	52	15	6.6	11	6.5	M8×1P	33	
4.762		3	1620	3205	80												27	
28	6	3.175	3	1030	2630	43	50	68	12	55	26	52	15	6.6	11	6.5	M8×1P	28
			4	1320	3510	45	77	73	12	60	30	60	15	6.6	11	6.5	M8×1P	37

FSIC

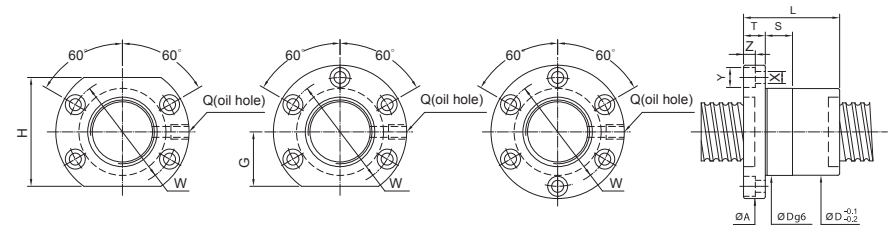

Unit:mm

SCREW SIZE	BALL DIA.	EFFECTIVE TURNS	BASIC RATE LOAD (kgf)		NUT		FLANGE					FIT		BOLT			OIL HOLE	STIFFNESS kgf/μm	
			Dynamic (1×10 ⁶ REV.) Ca	Static Co	Dg6	L	A	T	W	G	H	S	X	Y	Z	Q			
32	4	2.381	3	560	1840	43	40	68	15	55	26	52	15	6.6	11	6.5	M8×1P	28	
			5	870	3070	49													45
	3	1095	3060	47														31	
5	3.175	4	1400	4080	48	53	73.5	12	60	30	60	15	6.6	11	6.5	M8×1P	41		
		6	1980	6120	62													60	
6	3.969	3	1500	3750	53													32	
		4	1920	5000	48	61	73.5	12	60	30	60	15	6.6	11	6.5	M8×1P	43		
	6	2720	7500	73														63	
8	4.762	3	1820	4230	50	68	83	16	66	32	64	15	6.6	11	6.5	M8×1P	32		
		4	2330	5640	77													43	
	3	2605	5310	54	80	88	16	70	34	68	15	9	14	8.5	M8×1P	33			
10	6.35	3	3340	7080	54	90	90	16	70	34	68	15	9	14	8.5	M8×1P	45		
		4	3340	7080	54	90	90	16	70	34	68	15	9	14	8.5	M8×1P	45		
	3	2605	5310	54	86	88	16	70	34	68	15	9	14	8.5	M8×1P	33			
36	5	3.175	4	1490	4690	52	56	88	16	70	34	68	15	9	14	8.5	M8×1P	46	
			4	2530	6630	55	73	88	16	72	29	58	15	9	14	8.5	M8×1P	48	
	10	6.35	3	2810	6210	58	78	89	18	77	36	72	20	11	17.5	11	M8×1P	37	
40	5	3.175	4	1575	5290	56												49	
			5	1910	6610	55	61	88.5	16	72	29	58	15	9	14	8.5	M8×1P	61	
	6	3.969	3	2230	7940	65												73	
			4	1660	4810	56													39
	8	4.762	3	1660	4810	56													39
			4	2130	6410	55	65	88.5	16	72	34	68	15	9	14	8.5	M8×1P	51	
	10	6.35	3	3020	9620	77													75
			4	2120	5720	64													40
		4.762	3	2720	7620	60	77	93	16	76	36	72	20	9	14	8.5	M8×1P	52	
12	7.144	3	3850	11430	94													77	
		4	3010	7100	83													41	
	6.35	3	3010	7100	82													41	
12	6.35	4	3850	9470	64	93	106	18	84	43	86	20	11	17.5	11	M8×1P	53		
		5	4670	11830	99													67	
	3	4010	9250	70	93	110	18	85	45	90	20	11	17.5	11	M8×1P	43			
4	5130	12330	103														56		

FSIC

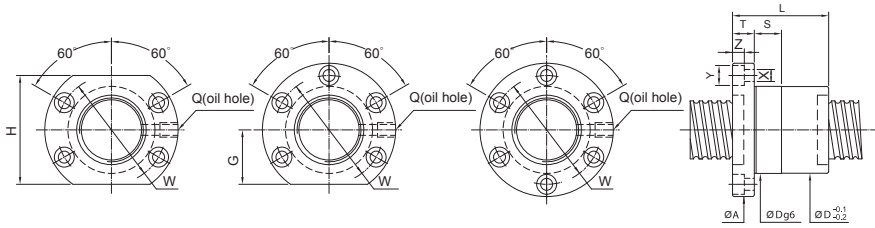

Unit:mm

SCREW SIZE		BALL DIA.	EFFECTIVE TURNS	BASIC RATE LOAD (kgf)		NUT		FLANGE					FIT			BOLT			OIL HOLE	STIFFNESS kgf/μm
O.D.	LEAD			Dynamic (1×10 ⁶ REV.) Ca	Static Co	Dg6	L	A	T	W	G	H	S	X	Y	Z	Q			
45	8	4.762	4	2870	8620	64	72	92	16	75	36	72	15	9	14.5	9	M6×1P	54		
	12	7.144	3	4160	10750	70	86	110	16	90	42	84	20	11	17.5	11	PT1/8"	48		
			4	5330	14330	70	99	110	16	90	42	84	20	11	17.5	11	PT1/8"	62		
16	6.35	3	3220	8200	70	102	110	16	90	42	84	20	11	17.5	11	PT1/8"	45			
50	5	3.175	4	1730	6760	55												60		
			5	2100	8450	66	61	98	16	82	36	72	20	9	14	8.5	PT1/8"	74		
			6	2450	10140	65													86	
	6	3.969	4	2380	8250	65													61	
			5	2880	10310	66	64	98	16	82	36	72	20	9	14	8.5	PT1/8"	76		
			6	3370	12380	77													90	
	8	4.762	4	3010	9610	79													63	
			5	3650	12010	70	84	113	18	90	42	84	20	11	17.5	11	PT1/8"	77		
			6	4260	14420	96													92	
	10	6.35	3	3430	9300	83													49	
			4	4390	12400	74	93	116	18	94	42	84	20	11	17.5	11	M8×1P	65		
			5	5320	15500	99													80	
6			6220	18600	114													95		
7.144			4	5520	16330	104													67	
			5	6690	20410	75	117	121	22	97	47	94	20	14	20	13	PT1/8"	84		
7.938	3	4510	11150	75	99	121	22	97	47	94	20	14	20	13	PT1/8"	50				
	4	5770	14870	111													60			
16	6.35	3	3430	9300	74	104	116	18	94	42	84	20	11	17.5	11	PT1/8"	49			
20	7.938	3	4510	11150	78	146	121	28	97	47	94	20	14	20	13	PT1/8"	50			

FSIC

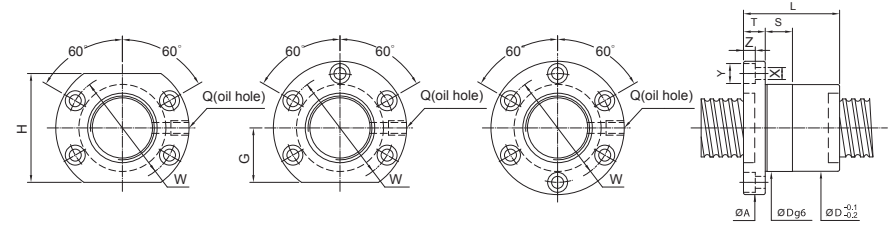

Unit:mm

SCREW SIZE		BALL DIA.	EFFECTIVE TURNS	BASIC RATE LOAD (kgf)		NUT		FLANGE					FIT			BOLT			OIL HOLE	STIFFNESS kgf/μm
O.D.	LEAD			Dynamic (1×10 ⁶ REV.) Ca	Static Co	Dg6	L	A	T	W	G	H	S	X	Y	Z	Q			
63	6	3.969	4	2610	10550	67	80	122	18	100	45	90	20	11	17.5	11	PT1/8"	73		
			6	3700	15830	80	80	124	18	102	46	92	20	11	17.5	11	PT1/8"	107		
	8	4.762	4	3375	12200	80	80	124	18	102	46	92	20	11	17.5	11	PT1/8"	76		
			6	4780	18300	82	96	124	18	102	46	92	20	11	17.5	11	PT1/8"	111		
	10	6.35	4	5020	16450	85	98	132	22	107	48	96	20	14	20	13	PT1/8"	79		
			6	7110	24680	118													116	
12	7.938	4	6580	19430	90	111	136	22	112	52	104	20	14	20	13	PT1/8"	80			
		6	9320	29150	136													111		
20	9.525	3	8490	23610	95	146	153	28	123	59	118	20	18	26	17.5	PT1/8"	79			
		4	10870	31480	156													89		
80	10	6.35	4	5510	21200	98												95		
			5	6670	26500	105	105	151	22	127	57	114	20	14	20	13	PT1/8"	118		
	6	7.938	4	7810	31800	118												140		
			6	10620	38550	136													143	
	12	9.525	4	7500	25700	110	111	156	22	132	59	118	20	14	20	13	PT1/8"	98		
			6	10620	38550	136													143	
20	9.525	3	9770	31700	115	146	173	28	143	66	132	20	18	26	17.5	PT1/8"	97			
		4	12510	42270	168													127		
100	10	6.35	3	4760	20090	84												91		
			4	6090	26790	95													120	
			5	7380	33490	125	104	171	22	147	67	134	25	14	20	13	PT1/8"	148		
	6	7.938	4	8630	40190	115													176	
			5	14440	54960	140													140	
			6	20460	82440	175													205	
20	9.525	4	14440	54960	159													140		
		5	17490	68700	135	157	205	28	169	73	146	30	18	26	17.5	PT1/8"	173			
		6	20460	82440	200													205		

FDIC

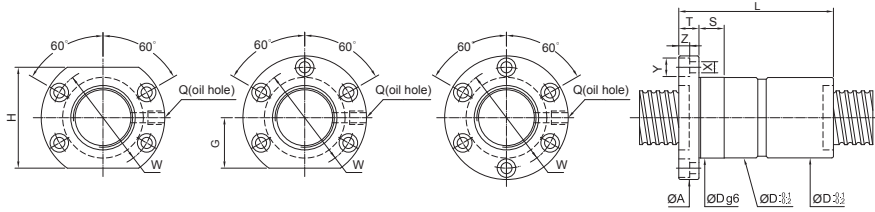

Unit:mm

SCREW SIZE		BALL DIA.	EFFECTIVE TURNS	BASIC RATE LOAD (kgf)		NUT	FLANGE					FIT	BOLT	OIL HOLE	STIFFNESS kgf/μm			
O.D.	LEAD			Dynamic (1×10 ⁷ REV.) Ca	Static Co		Dg6	L	A	T	W					G	H	S
16	4	2.381	3	435	920	30	66	48.5	10	39	20	40	10	4.5	8	4.5	M6×1P	31
	5	3.175	3	765	1240	30	80	49	10	39	20	40	10	4.5	8	4.5	M6×1P	35
20	5	3.175	3	860	1710	34	82	57	12	45	20	40	12	5.5	9.5	5.5	M6×1P	43
	6	3.969	3	1080	2050	34	93	57	12	45	20	40	12	5.5	9.5	5.5	M6×1P	43
25	5	3.175	3	980	2300	40	82	63.5	12	51	22	44	15	5.5	9.5	5.5	M8×1P	51
	6	3.969	3	1275	2740	40	93	63.5	12	51	22	44	15	5.5	9.5	5.5	M8×1P	52
32	5	3.175	3	1095	3060	48	82	73.5	12	60	30	60	15	6.6	11	6.5	M8×1P	63
	6	3.969	3	1500	3750	48	93	73.5	12	60	30	60	15	6.6	11	6.5	M8×1P	65
36	5	3.175	3	1490	4690	52	96	88	16	70	34	68	15	9	14	8.5	M8×1P	91
	8	4.762	3	2605	5310	54	139	88.5	16	70	34	68	15	9	14	8.5	M8×1P	95
45	8	4.762	3	2810	6210	58	138	98	18	77	36	72	20	11	17.5	11	M8×1P	75
	10	6.35	3	3600	8280	58	159	98	18	77	36	72	20	11	17.5	11	M8×1P	98

FDIC

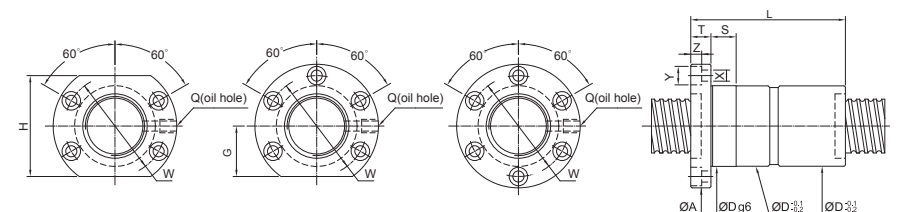

Unit:mm

SCREW SIZE		BALL DIA.	EFFECTIVE TURNS	BASIC RATE LOAD (kgf)		NUT	FLANGE					FIT	BOLT	OIL HOLE	STIFFNESS kgf/μm			
O.D.	LEAD			Dynamic (1×10 ⁷ REV.) Ca	Static Co		Dg6	L	A	T	W					G	H	S
40	5	3.175	4	1575	5290	96	111	88.5	16	72	29	58	15	9	14	8.5	M8×1P	100
	6	3.969	4	2130	6410	55	113	88.5	16	72	34	68	15	9	14	8.5	M8×1P	124
45	8	4.762	3	1660	4810	97	121	92	16	75	36	72	15	9	14.5	9	M6×1P	109
	10	6.35	3	2120	5720	60	134	93	16	76	36	72	20	9	14	8.5	M8×1P	124
50	10	6.35	4	2720	7620	60	134	93	16	76	36	72	20	9	14	8.5	M8×1P	124
	12	7.144	3	3850	11430	63	142	106	18	84	43	86	20	11	17.5	11	M8×1P	133
55	12	7.144	3	3010	7100	142	154	106	18	84	43	86	20	11	17.5	11	M8×1P	82
	16	6.35	3	3010	7100	63	204	106	18	84	43	86	20	11	17.5	11	M8×1P	133
60	12	7.144	3	4010	9250	70	160	110	18	85	45	90	20	11	17.5	11	M8×1P	86
	16	6.35	3	5130	12330	70	185	110	16	90	45	90	20	11	17.5	11	PT1/8"	114
65	8	4.762	4	2870	8620	64	136	92	16	75	36	72	15	9	14.5	9	M6×1P	109
	12	7.144	3	4160	10750	70	158	110	16	90	45	90	20	11	17.5	11	PT1/8"	94
70	12	7.144	4	5330	14330	70	183	110	16	90	45	90	20	11	17.5	11	PT1/8"	124
	16	6.35	3	3220	8200	70	198	110	16	90	45	90	20	11	17.5	11	PT1/8"	90

FDIC

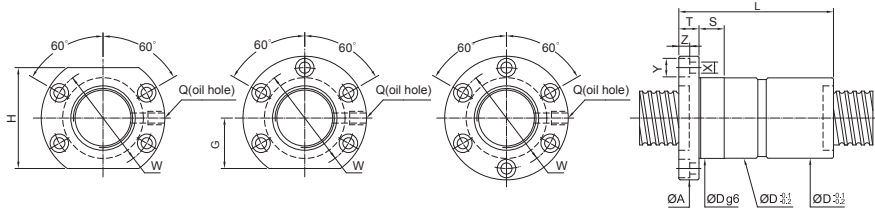

Unit:mm

SCREW SIZE		BALL DIA.	EFFECTIVE TURNS	BASIC RATE LOAD (kgf)		NUT		FLANGE					FIT			BOLT			OIL HOLE	STIFFNESS kgf/mm
O.D.	LEAD			Dynamic (1×10 ⁶ REV.) Ca	Static Co	Dg6	L	A	T	W	G	H	S	X	Y	Z	Q			
50	5	3.175	4	1730	6760	96													119	
			5	2100	8450	66	111	98	16	82	36	72	20	9	14	8.5	PT1/8"	148		
			6	2450	10140	122													174	
	6	3.969	4	2380	8250	111													123	
			5	2880	10310	66	122	98	16	82	36	72	20	9	14	8.5	PT1/8"	151		
			6	3370	12380	142													181	
	8	4.762	4	3010	9610	136													125	
			5	3650	12010	70	157	113	18	90	42	84	20	11	17.5	11	PT1/8"	155		
			6	4260	14420	174													185	
	10	6.35	3	3430	9300	143													99	
			4	4390	12400	74	162	114	18	92	42	84	20	11	17.5	11	PT1/8"	129		
			5	5320	15500	189													161	
	12	7.938	6	6220	18600	205													191	
			7.144	5	6680	20420	75	213	121	22	97	47	94	20	14	20	13	PT1/8"	166	
			3	4510	11150	75	171	121	22	97	47	94	20	14	20	13	PT1/8"	101		
	16	6.35	4	5770	14870	195													132	
			3	3430	9300	74	201	114	18	92	42	84	20	11	17.5	11	PT1/8"	99		
			3	4510	11150	78	253	121	28	97	47	94	20	14	20	13	PT1/8"	101		

FDIC

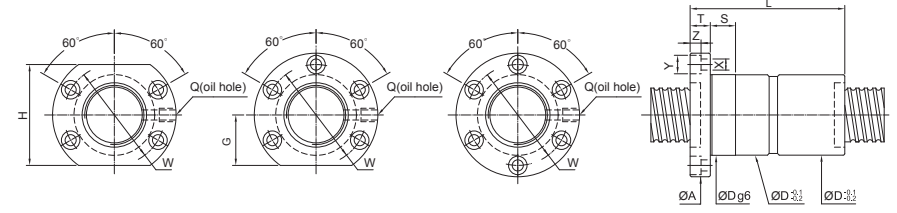

Unit:mm

SCREW SIZE		BALL DIA.	EFFECTIVE TURNS	BASIC RATE LOAD (kgf)		NUT		FLANGE					FIT			BOLT			OIL HOLE	STIFFNESS kgf/mm
O.D.	LEAD			Dynamic (1×10 ⁶ REV.) Ca	Static Co	Dg6	L	A	T	W	G	H	S	X	Y	Z	Q			
63	6	3.969	4	2610	10550	120													146	
			6	3700	15830	80	144	122	18	100	45	90	20	11	17.5	11	PT1/8"	217		
	8	4.762	4	3375	12200	82	141	124	18	102	46	92	20	11	17.5	11	PT1/8"	151		
			6	4780	18300	178													222	
	10	6.35	4	5020	16450	85	166	132	22	107	48	96	20	14	20	13	PT1/8"	158		
			6	7110	24680	209													232	
12	7.938	4	6580	19430	90	195	136	22	112	52	104	20	14	20	13	PT1/8"	161			
		6	9320	29150	248													236		
20	9.525	3	8490	23610	95	255	153	28	123	59	118	20	18	26	17.5	PT1/8"	157			
		4	10870	31480	296													207		
80	10	6.35	4	5510	21200	166													190	
			5	6670	26500	105	185	151	22	127	57	114	20	14	20	13	PT1/8"	235		
			6	7810	31800	209													280	
	12	7.938	4	7500	25700	110	195	156	22	132	59	118	20	14	20	13	PT1/8"	196		
			6	10620	38550	248													288	
			3	9770	31700	254													193	
20	9.525	4	12510	42270	115	297	173	28	143	66	132	20	18	26	17.5	PT1/8"	254			
		6	17720	63410	376													373		
100	10	6.35	3	4760	20090	143													173	
			4	6090	26790	125	164	171	22	147	67	134	25	14	20	13	PT1/8"	228		
			5	7380	33490	184													281	
	16	9.525	6	8630	40190	210													334	
			4	14440	54960	252													266	
			5	17490	68700	135	285	205	28	169	73	146	30	18	26	17.5	PT1/8"	329		
20	9.525	6	20460	82440	318													391		
		4	14440	54960	299													266		
20	9.525	5	17490	68700	135	340	205	28	169	73	146	30	18	26	17.5	PT1/8"	329			
		6	20460	82440	381													391		

FOIC

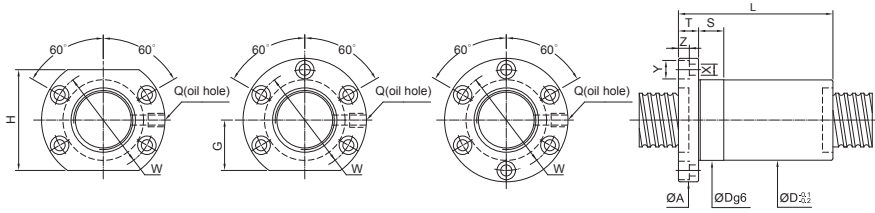

Unit:mm

SCREW SIZE	O.D.	LEAD	BALL DIA.	EFFECTIVE TURNS	BASIC RATE LOAD (kgf)		NUT		FLANGE					FIT			BOLT			OIL HOLE	STIFFNESS kgf/μm
					Dynamic (1×10 ⁶ REV.) Ca	Static Co	Dg6	L	A	T	W	G	H	S	X	Y	Z	Q			
20	5	3.175	3.175	2×(2)	610	1140	53	57	12	45	20	40	12	5.5	9.5	5.5	M6×1P	29			
				3×(2)	860	1710	34	67	12	45	20	40	12	5.5	9.5	5.5	M6×1P	43			
20	6	3.969	3.969	2×(2)	760	1370	61	57	12	45	20	40	12	5.5	9.5	5.5	M6×1P	29			
				3×(2)	1080	2050	34	77	12	45	20	40	12	5.5	9.5	5.5	M6×1P	50			
25	4	2.381	2.381	2×(2)	350	960	44										M8×1P	30			
				3×(2)	500	1440	40	56	63	12	51	22	44	15	5.5	9.5	5.5	M8×1P	46		
				4×(2)	640	1920	64													59	
				2×(2)	690	1530	53														35
				3×(2)	980	2300	40	67	63.5	12	51	22	44	15	5.5	9.5	5.5	M8×1P	51		
				4×(2)	1250	3070	76														
25	6	3.969	3.969	3×(2)	1275	2740	40	77	63.5	12	51	22	44	15	5.5	9.5	5.5	M8×1P	52		
				3×(2)	1275	2740	40	85	63.5	12	51	22	44	15	5.5	9.5	5.5	M8×1P	52		
				2×(2)	1140	2140	88	69	15	55	26	52	15	6.6	11	6.5	M8×1P	36			
				3×(2)	1610	3210	42	102													53
28	6	3.175	3.175	3×(2)	1030	2630	43	69	68	12	55	26	52	15	6.6	11	6.5	M8×1P	56		
				2×(2)	730	1750	45	77	73	12	60	30	60	15	6.6	11	6.5	M8×1P	38		
32	4	2.381	2.381	3×(2)	560	1840	56	68	12	55	26	52	15	6.6	11	6.5	M8×1P	55			
				5×(2)	870	3070	43	73												89	
				3×(2)	1095	3060	67	73.5	12	60	30	60	15	6.6	11	6.5	M8×1P	63			
				4×(2)	1400	4080	48	77													82
32	6	3.969	3.969	3×(2)	1500	3750	77	73.5	12	60	30	60	15	6.6	11	6.5	M8×1P	65			
				4×(2)	1920	5000	48	90												86	
				3×(2)	1820	4230	95	83	16	66	32	64	15	6.6	11	6.5	M8×1P	66			
				4×(2)	2330	5640	50	112													86
32	10	6.35	6.35	3×(2)	2605	5310	54	120	88	16	70	34	68	15	9	14	8.5	M8×1P	67		
				3×(2)	2605	5310	54	124	88	16	70	34	68	15	9	14	8.5	M8×1P	67		

FOIC

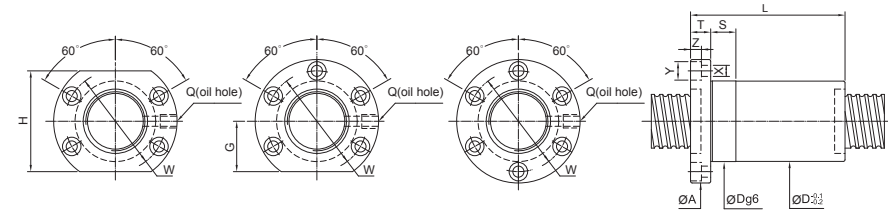

Unit:mm

SCREW SIZE	O.D.	LEAD	BALL DIA.	EFFECTIVE TURNS	BASIC RATE LOAD (kgf)		NUT		FLANGE					FIT			BOLT			OIL HOLE	STIFFNESS kgf/μm		
					Dynamic (1×10 ⁶ REV.) Ca	Static Co	Dg6	L	A	T	W	G	H	S	X	Y	Z	Q					
40	5	3.175	3.175	3×(2)	1230	3970	65														75		
				4×(2)	1575	5290	55	80	88.5	16	72	29	58	15	9	14	8.5	M8×1P	100				
				6×(2)	2230	7940	101																147
				4×(2)	2130	6410	93	88.5	16	72	34	68	15	9	14	8.5	M8×1P	103					
40	6	3.969	3.969	6×(2)	3020	9620	55	118													149		
				4×(2)	2720	7620	60	116	93	16	76	36	72	20	9	14	8.5	M8×1P	105				
				3×(2)	3010	7100	123	106	18	84	43	86	20	11	17.5	11	PT1/8"	82					
				4×(2)	3850	9470	64	143															107
40	12	6.35	6.35	4×(2)	3850	9470	63	160	106	18	84	43	86	20	11	17.5	11	PT1/8"	107				
				3×(2)	1350	5070	65															89	
				4×(2)	1730	6760	66	80	98	16	82	36	72	20	9	14	8.5	PT1/8"	119				
				6×(2)	2450	10140	101																174
50	6	3.969	3.969	4×(2)	2380	8250	93	98	16	82	36	72	20	9	14	8.5	PT1/8"	123					
				6×(2)	3370	12380	66	118														181	
				4×(2)	3010	9610	70	119	113	18	90	42	84	20	11	17.5	11	PT1/8"	125				
				3×(2)	3430	9300	123	116	18	92	42	84	20	11	17.5	11	M8×1P	99					
50	10	6.35	6.35	4×(2)	4390	12400	74	143													129		
				7.144	5530	16330	75	164	121	22	97	47	94	20	14	20	13	PT1/8"	135				
				3×(2)	4510	11150	147	121	22	97	47	94	20	14	20	13	PT1/8"	101					
				4×(2)	5770	14870	75	164															132
63	6	3.969	3.969	4×(2)	2610	10550	96	122	18	100	45	90	20	11	17.5	11	PT1/8"	146					
				6×(2)	3700	15830	80	121														217	
				4×(2)	3375	12200	82	119	124	18	102	46	92	20	11	17.5	11	PT1/8"	151				
				4×(2)	5020	16450	85	147	132	22	107	48	96	20	14	20	13	PT1/8"	158				
63	10	6.35	6.35	3×(2)	5140	14570	147	136	22	112	52	104	20	14	20	13	PT1/8"	122					
				4×(2)	6580	19430	90	171														161	
				2×(2)	5990	15740	95	156	153	28	123	59	118	20	18	26	17.5	PT1/8"	107				
				2×(2)	3360	13390	95	171	22	147	67	134	25	14	20	13	PT1/8"	118					
80	10	6.35	6.35	3×(2)	4760	20090	105	115													173		
				2×(2)	11280	41220	115	175	205	28	169	73	146	30	18	26	17.5	PT1/8"	201				
				3×(2)	7960	27480	115	159	205	28	169	73	146	30	18	26	17.5	PT1/8"	137				
				2×(2)	11280	41220	115	175	205	28	169	73	146	30	18	26	17.5	PT1/8"	201				

RSIC

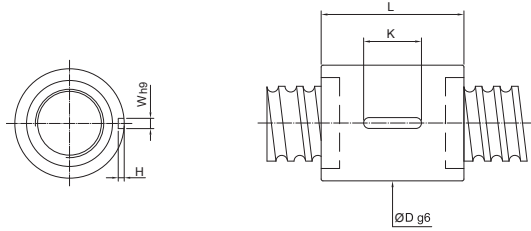

Unit:mm

SCREW SIZE		BALL DIA.	EFFECTIVE TURNS	BASIC RATE LOAD (kgf)		NUT		KEYWAY			STIFFNESS
O.D.	LEAD			Dynamic (1×10 ⁶ REV.) Ca	Static Co	Dg6	L	K	W	H	kgf/μm
16	5	3.175	3	765	1240	30	40	20	3	1.8	18
			4	860	1710	34	41	20	3	1.8	21
20	5	3.175	3	1100	2280	34	48	20	3	1.8	28
			4	1080	2050	34	46	20	4	2.5	22
25	6	3.969	3	1380	2730	34	56	25	4	2.5	28
			4	980	2300	40	41	20	4	2.5	26
32	5	3.175	3	1250	3070	40	48	20	4	2.5	33
			4	1275	2740	40	46	20	4	2.5	26
40	6	3.969	3	1630	3650	40	56	25	4	2.5	34
			4	1095	3060	41	20	4	2.5	31	
50	5	3.175	3	1400	4080	48	48	20	4	2.5	41
			4	1980	6120	61	25	60			
63	6	3.969	3	1500	3750	46	20	5	3.0	32	
			4	1920	5000	50	56	25	5	3.0	43
80	8	4.762	3	2720	7500	70	32	6	3.5	63	
			4	1820	4230	59	25	5	3.0	32	
100	10	6.35	3	2330	5640	50	70	25	5	3.0	43
			4	2605	5310	68	25	6	3.5	33	
125	5	3.175	3	3340	7080	54	79	32	6	3.5	45
			4	1575	5290	55	48	20	4	2.5	49
160	6	3.969	3	2230	7940	55	61	25	4	2.5	73
			4	2130	6410	55	56	25	5	3.0	51
200	8	4.762	3	3020	9620	55	70	32	5	3.0	75
			4	2720	7620	60	70	25	5	3.0	52
250	10	6.35	3	3850	11430	60	91	40	5	3.0	77
			4	3010	7100	65	68	25	6	3.5	41
315	10	6.35	3	3850	9470	65	79	32	6	3.5	53
			4								

RSIC

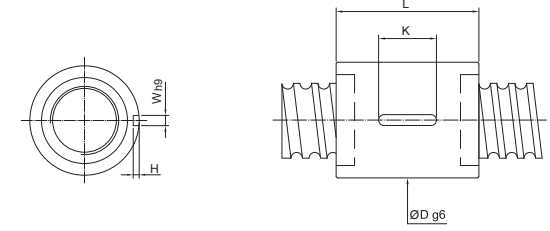

Unit:mm

SCREW SIZE		BALL DIA.	EFFECTIVE TURNS	BASIC RATE LOAD (kgf)		NUT		KEYWAY			STIFFNESS
O.D.	LEAD			Dynamic (1×10 ⁶ REV.) Ca	Static Co	Dg6	L	K	W	H	kgf/μm
50	5	3.175	4	1730	6750	66	48	20	4	2.5	60
			6	2450	10130	66	61	25	4	2.5	86
63	6	3.969	4	2380	8250	66	56	25	5	3.0	61
			6	3370	12380	66	70	32	5	3.0	90
80	8	4.762	4	3010	9610	70	70	32	5	3.0	63
			6	4260	14420	70	91	32	5	3.0	92
100	10	6.35	3	3430	9300	74	68	32	6	3.5	49
			4	4390	12400	74	79	32	6	3.5	65
125	12	7.938	3	6220	18600	74	102	32	6	3.5	95
			4	4510	11150	75	82	40	6	3.5	50
160	6	3.969	4	5770	14870	75	95	40	6	3.5	66
			6	2610	10550	80	56	25	6	3.5	73
200	8	4.762	4	3700	15830	80	70	32	6	3.5	107
			6	3375	12200	82	70	32	6	3.5	76
250	10	6.35	4	4780	18300	82	91	40	6	3.5	111
			6	5020	16450	85	79	32	8	4.0	79
315	12	7.938	4	7110	24680	85	85	40	8	4.0	116
			6	6580	19430	90	95	40	8	4.0	80
400	10	6.35	4	9320	29150	90	123	50	8	4.0	118
			6	5510	21200	105	79	32	8	4.0	95
500	12	7.938	4	7810	31800	105	102	40	8	4.0	140
			6	7500	25700	110	95	40	8	4.0	98
630	20	9.525	3	10620	38550	110	123	50	8	4.0	143
			4	9770	31700	115	126	50	10	5.0	97
800	10	6.35	3	12510	42270	115	149	63	10	5.0	127
			4	4760	20090	125	72	32	10	5	91
1000	16	9.525	4	6090	26790	125	82	50	10	5	120
			5	7380	33490	125	94	50	10	5	148
1250	20	12.7	4	8630	40190	125	104	63	10	5	176
			6	14440	54960	135	128	63	10	5	140
1600	16	9.525	4	14440	54960	135	144	63	10	5	140
			5	17490	68700	135	77	63	10	5	173
2000	20	12.7	4	20460	82440	135	162	63	10	5	205
			6	14440	54960	144	144	63	10	5	140
2500	20	12.7	4	17490	68700	135	164	63	10	5	173
			6	20460	82440	135	187	63	10	5	205

RDIC

RDIC

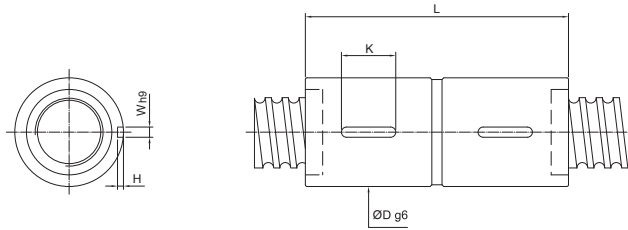

Unit:mm

SCREW SIZE		BALL DIA.	EFFECTIVE TURNS	BASIC RATE LOAD (kgf)		NUT		KEYWAY			STIFFNESS
O.D.	LEAD			Dynamic (1×10 ⁶ REV.) Ca	Static Co	Dg6	L	K	W	H	kgf/μm
16	5	3.175	3	765	1240	28	75	20	3	1.8	35
			4	980	1650		85				47
20	5	3.175	3	860	1710	34	75	20	3	1.8	43
			4	1100	2280		85				56
20	6	3.969	3	1080	2050	34	87	20	4	2.5	43
			4	1380	2730		103	25			56
25	5	3.175	3	980	2300	40	75	20	4	2.5	51
			4	1250	3070		85				67
25	6	3.969	3	1275	2740	40	87	20	4	2.5	52
			4	1630	3650		103	25			68
32	5	3.175	3	1095	3060		75	20			63
			4	1400	4080	48	85	20	4	2.5	82
			6	1980	6120		105	25			122
	6	3.969	3	1500	3750		87	20			65
			4	1920	5000	50	103	25	5	3.0	86
			6	2720	7500		127	32			125
8	4.762	3	1820	4230	50	109		5	3.0	66	
		4	2330	5640		127				86	
10	6.35	3	2605	5310		135	25	6	3.5	67	
		4	3340	7080	54	155	32			89	
40	5	3.175	4	1575	5290		85	20	4	2.5	100
			6	2230	7940	55	105	25			147
	6	3.969	4	2130	6410		103	25	5	3.0	103
			6	3020	9620	55	127	32			149
	8	4.762	4	2720	7620	60	127	25	5	3.0	105
6			3850	11430		161	40			154	
10	6.35	3	3010	7100		135	25	6	3.5	82	
		4	3850	9470	65	155	32			107	

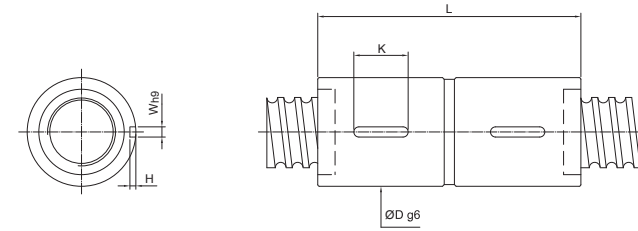

Unit:mm

SCREW SIZE		BALL DIA.	EFFECTIVE TURNS	BASIC RATE LOAD (kgf)		NUT		KEYWAY			STIFFNESS
O.D.	LEAD			Dynamic (1×10 ⁶ REV.) Ca	Static Co	Dg6	L	K	W	H	kgf/μm
50	5	3.175	4	1730	6750	66	85	20	4	2.5	119
			6	2450	10130		105	25			174
50	6	3.969	4	2380	8250	66	103	25	5	3.0	123
			6	3370	12380		127	32			181
50	8	4.762	4	3010	9610	70	127	32	5	3.0	125
			6	4260	14420		161				185
50	10	6.35	3	3430	9300		135	32			99
			4	4390	12400	74	155	32	6	3.5	129
50	12	7.938	3	4510	11150		161	40	6	3.5	101
			4	5770	14870	75	185	40			132
63	6	3.969	4	2610	10550	80	106	25	6	3.5	146
			6	3700	15830		130	32			217
63	8	4.762	4	3375	12200	82	131	32	6	3.5	151
			6	4780	18300		165	40			222
63	10	6.35	4	5020	16450	85	160	32	8	4.0	158
			6	7110	24680		202	40			232
63	12	7.938	4	6580	19430	90	185	40	8	4.0	161
			6	9320	29150		238	50			236
80	10	6.35	4	5510	21200	105	160	32	8	4.0	190
			6	7810	31800		202	40			280
80	12	7.938	4	7500	25700	110	185	40	8	4.0	196
			6	10620	38550		238	50			288
80	20	9.525	3	9770	31700		245	50	10	5.0	193
			4	12510	42270	115	289	63			254
100	10	6.35	3	4760	20090		132				173
			4	6090	26790	125	164	50	10	5	228
			5	7380	33490		174				281
	16	9.525	4	8630	40190		204				334
			5	14440	54960		240				266
			6	20460	82440	135	274	63	10	5	329
20	9.525	4	14440	54960		284				266	
		5	17490	68700	135	324	63	10	5	329	
		6	20460	82440		306				391	
20	9.525	4	14440	54960		284				266	
		5	17490	68700	135	324	63	10	5	329	
		6	20460	82440		366				391	

Features

It is important for a high-lead ballscrew to be with characteristics of high rigidity, low noise and thermal control.

Its characteristics are as follow:

High DN Value

Max. DN Value: 220,000

Low Noise

The average and accurate ball circle diameter (BCD) through whole threads make the ballscrews to obtain the stable and consistent drag torque as well as to reduce the noise.

The audio frequency is low and downy due to the designed of plastic circulation system.

Space Saving

The ballnut diameter reduces 20%~25% substantially and the length of nut is shorter.

The total space shall be reduced to approximately 50% consequently.

Circulation

The specially designed pathway of the Recirculation System makes a contact with lead angle and also with BCD in the same tangency, improving its smoothness effectively.

Applications

CNC Machinery / Precision Machinery / High Speed Machinery /
Semi-Conductor Equipment / Medical equipment

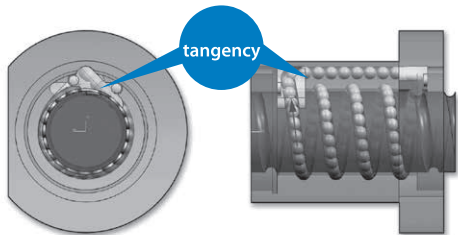
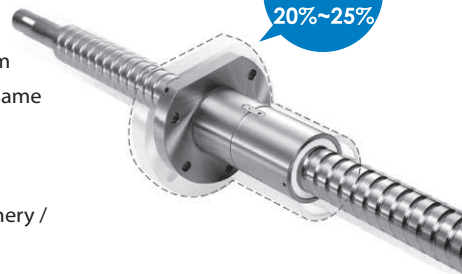

Note: The ball diameter above(include) 7.983mm of End Deflector is made from metal.

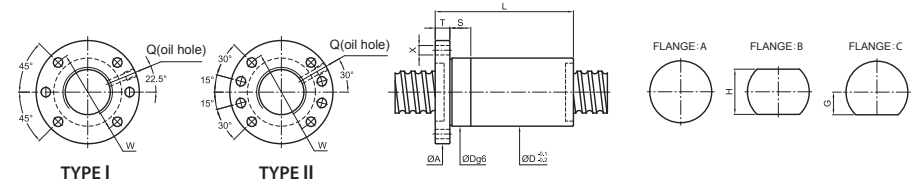

Unit:mm

SCREW SIZE	O.D.	LEAD	BALL DIA.	EFFECTIVE TURNS	MODIFIED LOAD CAPACITY (kgf)		NUT		FLANGE					FIT	OIL HOLE	BOLT	STIFFNESS	
					Dynamic (1×10 ⁶ REV.) Cam	Static Coam	Dg6	L	A	T	W	G	H					TYPE
12	4		2.381	3	610	1190	28											20
	5			3	610	1190	24	32	44	10	34	16	32	I	10	M6×1P	4.5	20
	10			3	590	1160	45											20
	20		2	390	770	54											14	
14	4		3.175	3	680	1430	26	28	46	10	36	16	32	I	10	M6×1P	4.5	23
	5			3	820	1520	28	32	49	10	36	16	32	I	10	M6×1P	4.5	25
15	5		3.175	3	850	1640	35											26
	10			3	840	1610	29	47	51	10	39	19	38	I	10	M6×1P	5.5	26
	20			2	560	1050	58											18
16	5		3.175	3	890	1760	29	35										27
	10			3	870	1740	29	50	51	10	39	19	38	I	10	M6×1P	5.5	27
	16			2	600	1150	29	51										19
20	4		2.381	3	780	2000	32	28	54	12	42	19	38	I	12	M6×1P	5.5	29
	5			4	1300	3030	40											43
	10		3.175	3	990	2220	36	47	62	12	49	24	48	I	12	M6×1P	6.6	33
	20			2	670	1450	56											23
	6			3	1540	3310	37	38	62	12	49	23	46	I	12	M6×1P	6.6	34
8		3	1540	3300	45	45	62	12	49	23	46	I	12	M6×1P	6.6	34		
10		4	4.762	4	2560	5530	40	62	62	12	51	24	48	I	15	M6×1P	6.6	47
25	4		2.381	3	870	2560	36	28	62	12	49	22	44	I	12	M6×1P	6.6	34
	5			4	1440	3840	41											50
	10		3.175	3	1100	2810	50											38
	15			4	1410	3780	40	81	62	12	51	24	48	I	15	M6×1P	6.6	50
	20			2	750	1840	60											26
	25		2	730	1810	71												26
	6		3.969	4	2250	5710	45											53
	12			4	2240	5660	43	70	64	12	51	24	48	I	15	M6×1P	6.6	53
	25		2	1160	2720	70												28
	8		4.762	4	2880	6890	55											55
	10			4	2880	6870	63											55
16		4		2830	6790	85	65	15	54	25.5	51		I	15	M6×1P	6.6	55	
20		2		1470	3180	61												29
10		5		6.35	5050	11500	51	78	84	16	67	32	64	I	15	M6×1P	9	72

Note: Coam and Cam are the modified static and dynamic load capacities,calculated according to ISO-3408-5

FSDC

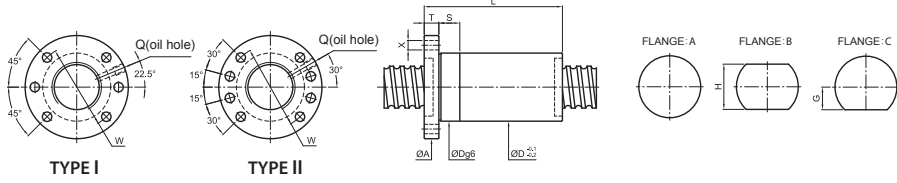

Unit: mm

SCREW SIZE		BALL DIA.	EFFECTIVE TURNS	MODIFIED LOAD CAPACITY (kgf)		NUT		FLANGE						FIT	OIL HOLE	BOLT	STIFFNESS
O.D.	LEAD			Dynamic (1×10 ⁶ REV.) Cam	Static Coam	Dg6	L	A	T	W	G	H	TYPE				
28	5	3.175	5	1850	5460	43	48	65	12	51	24	48	I	15	M8×1P	6.6	67
	6	3.969	5	2880	7980	46	52	66	12	54	26	52	I	15	M8×1P	6.6	70
	8		3	2350	5720	46											46
	10	4.762	3	2340	5710	48	52	74	12	60	30	60	I	15	M8×1P	6.6	46
	16		5	3680	9690	102											73
	12	6.35	5	5280	12530	54	78	87	16	72	34.5	69	I	15	M8×1P	9	77
32	12		5	5270	12500	54	88										77
	5	3.175	4	1610	4970	50	41	87	16	72	34.5	69	I	15	M8×1P	9	61
	6		5	3050	9140	52											77
	10	3.969	4	2550	7500	53	62	87	16	72	34.5	69	I	15	M8×1P	9	63
	32		2	1300	3540	90											40
	8		5	3900	10930	67											80
	10		5	3890	10910	77											80
	12	4.762	5	3890	10890	53	87	87	16	72	34.5	69	I	15	M8×1P	9	80
	15		5	3860	10850	53	116										80
	20		2	1700	4230	70											34
	32		2	1640	4120	90											34
	10		5	4900	13360	78											84
	12		5	4890	13340	88											84
	16	5.556	5	4860	13280	55	107	87	16	72	34.5	69	I	15	M8×1P	9	79
20		3	3140	8110	87											53	
10		5	5720	14490	78											85	
12		5	5710	14470	57	88	87	16	72	34.5	69	I	15	M8×1P	9	85	
16	6.35	4	4520	11100	92											69	
20		3	3530	8340	88											54	

Note: Coam and Cam are the modified static and dynamic load capacities,calculated according to ISO-3408-5

FSDC

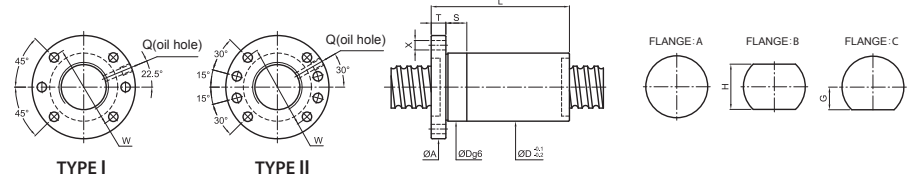

Unit: mm

SCREW SIZE		BALL DIA.	EFFECTIVE TURNS	MODIFIED LOAD CAPACITY (kgf)		NUT		FLANGE						FIT	OIL HOLE	BOLT	STIFFNESS
O.D.	LEAD			Dynamic (1×10 ⁶ REV.) Cam	Static Coam	Dg6	L	A	T	W	G	H	TYPE				
36	8	4.762	5	4170	12580	56	63	84	11	68	34	68	I	15	M8×1P	9	86
	10		5	6050	16460	78											93
	12		5	6080	16430	88											93
	16	6.35	5	6050	16360	61	109	91	18	76	34	68	II	15	M8×1P	9	93
	20		4	4910	12890	109											76
	36		2	2570	6250	95											41
38	10		5	6260	17740	80											97
	12	6.35	5	6260	17410	63	88	93	18	78	35	70	II	20	M8×1P	9	97
	16		5	6220	17350	109											97
40		3	3830	10220	142											71	
40	5	3.175	4	1760	6260	58	42	91	18	76	34	68	II	15	M8×1P	9	71
	6	3.969	5	3420	11810	58	52	91	18	76	34	68	II	15	M8×1P	9	92
	8	4.762	4	3610	11260	60	56	91	18	76	34	68	II	15	M8×1P	9	77
	10		5	6430	18440	78											101
	12		5	6420	18410	88											101
	15	6.35	5	6380	18350	65	103	95	18	80	36	72	II	20	M8×1P	9	101
	16		5	6390	18330	108											101
	20		4	5190	14450	110	98	18	83	37	74		II	20	M8×1P	11	82
	40		2	2700	6950	110	98	18	83	37	74		II	20	M8×1P	11	43
	12	7.144	5	7530	20800	70	110	98	18	83	37	74	II	20	M8×1P	11	103
16		5	7500	20730	110											103	

Note: Coam and Cam are the modified static and dynamic load capacities,calculated according to ISO-3408-5

FSDC

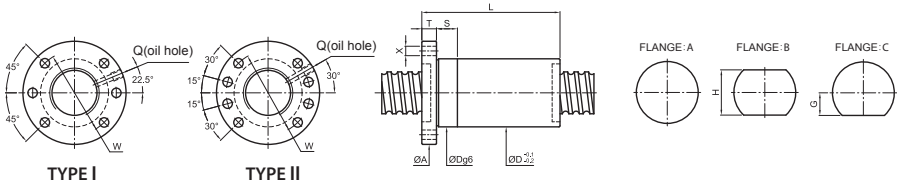

Unit:mm

SCREW SIZE		BALL DIA.	EFFECTIVE TURNS	MODIFIED LOAD CAPACITY (kgf)		NUT		FLANGE						FIT	OIL HOLE	BOLT	STIFFNESS
O.D.	LEAD			Dynamic (1×10 ⁶ REV.) Cam	Static Coam	Dg6	L	A	T	W	G	H	TYPE				
45	8	4.762	4	3770	12580	66	55	98	18	83	37	74	II	20	M8×1P	11	84
	10		5	6910	21330		78										110
	12	6.35	5	6910	21310	70	89	105	18	88	40	80	II	20	M8×1P	11	110
	16		5	6880	21250		111										110
	12	7.144	5	7930	23300	73	88	105	18	88	40	80	II	20	M8×1P	11	113
	20		4	6440	18340	73	110										91
50	5	3.175	5	2360	9950	70	48	105	18	88	40	80	II	20	M8×1P	11	105
	8	4.762	5	4780	17550	70	64	105	18	88	40	80	II	20	M8×1P	11	109
	10		5	7160	23320		78										119
	12	6.35	5	7150	23300		90										119
	16		5	7120	23250	75	109	118	18	100	46	92	II	20	M8×1P	11	119
	20		3	4460	13520		95										74
20	7.938	4	7810	22680	80	114	121	18	104	50	100	II	25	M8×1P	11	101	
55	12	6.35	5	7340	25280	80	96	118	18	100	46	92	II	20	M8×1P	11	128
63	10	6.35	5	7800	29210	88	84	135	22	115	50	110	II	20	M8×1P	11	141
	16	9.525	5	13640	43620	102	116	147	20	127	56	112	II	25	M8×1P	14	167
80	20		5	15350	56760		143										196
	25	9.525	4	12530	44860	118	146	165	25	145	65	130	II	25	M8×1P	14	159
	30		3	9610	32980		134										121

Note: Coam and Cam are the modified static and dynamic load capacities,calculated according to ISO-3408-5

FDDC

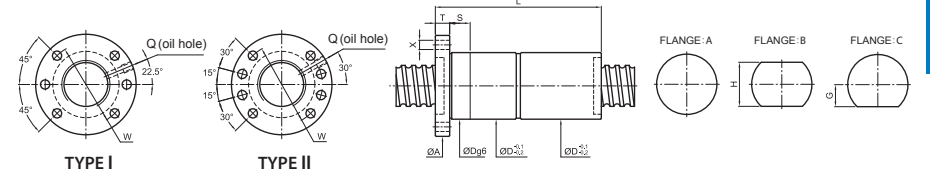

Unit:mm

SCREW SIZE		BALL DIA.	EFFECTIVE TURNS	MODIFIED LOAD CAPACITY (kgf)		NUT		FLANGE						FIT	OIL HOLE	BOLT	STIFFNESS	
O.D.	LEAD			Dynamic (1×10 ⁶ REV.) Cam	Static Coam	Dg6	L	A	T	W	G	H	TYPE					S
20	4	2.381	3	780	2000	32	61	54	12	42	19	38	I	12	M6×1P	5.5	44	
	5		4	1300	3030		80										65	
	10	3.175	3	990	2220	36	97	62	12	49	24	48	I	12	M6×1P	6.6	50	
	20		2	670	1450		116										33	
	6	3.969	3	1540	3310	37	81	62	12	49	19	38	I	12	M6×1P	6.6	51	
	8		3	1540	3300	37	93										51	
10	4.762	4	2560	5530	40	107	62	12	51	24	48	I	15	M6×1P	6.6	70		
25	4	2.381	3	870	2560	36	60	62	12	49	19	38	I	12	M6×1P	6.6	53	
	5		4	1440	3840		81										77	
	10		3	1100	2810		100										58	
	15	3.175	4	1410	3780	40	166	62	12	51	24	48	I	15	M6×1P	6.6	77	
	20		2	750	1840		120										39	
	25		2	730	1810		146										39	
	6	3.969	4	2250	5710		87										80	
	12		4	2240	5660	43	142	64	12	51	22	44	I	15	M6×1P	6.6	80	
	25			2	1160	2720		145										41
	8			4	2880	6890		111										83
10	4.762	4	2880	6870		128											83	
16		4	2830	6790	45	173	65	15	54	25.5	51	I	15	M6×1P	6.6	83		
20			2	1470	3180		122										42	
10		6.35	5	5050	11500	51	153	84	16	67	32	64	I	15	M6×1P	9	108	

Note: Coam and Cam are the modified static and dynamic load capacities,calculated according to ISO-3408-5

FDDC

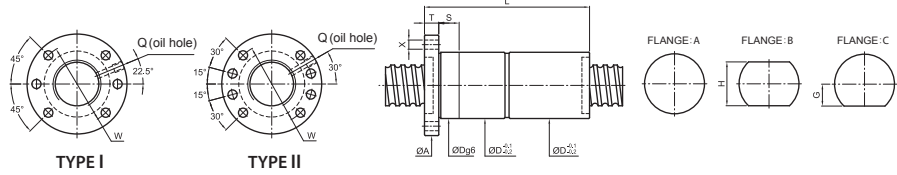

Unit: mm

SCREW SIZE		BALL DIA.	EFFECTIVE TURNS	MODIFIED LOAD CAPACITY (kgf)		NUT		FLANGE						FIT	OIL HOLE	BOLT	STIFFNESS
O.D.	LEAD			Dynamic (1×10 ⁶ REV.) Cam	Static Coam	Dg6	L	A	T	W	G	H	TYPE				
28	5	3.175	5	1850	5460	43	93	65	12	51	24	48	I		M8×1P	6.6	104
	6	3.969	5	2880	7980	46	106	66	12	50	26	52	I		M8×1P	6.6	108
	8		3	2350	5720		94										69
	10	4.762	3	2340	5710	48	102	74	12	60	30	60	I	15	M8×1P	6.6	69
	16		5	3680	9690		206										112
	10		5	5280	12530		158										118
	12	6.35	5	5270	12500	54	172	87	16	72	34.5	69	I		M8×1P	9	118
	12		5	5270	12500		172										118
32	5	3.175	4	1610	4970	50	81	87	16	72	34.5	69	I	15	M8×1P	9	93
	6		5	3050	9140		106										120
	10	3.969	4	2550	7500	53	126	87	16	72	34.5	69	I	15	M8×1P	9	96
	32		2	1300	3540		172										60
	8		5	3900	10930		132										124
	10		5	3890	10910		147										124
	12		5	3890	10890		171										124
	15	4.762	5	3860	10850	53	221	87	16	72	34.5	69	I	15	M8×1P	9	124
	20		2	1700	4230		140										51
	32		2	1640	4120		186										51
	10		5	4900	13360		153										129
	12		5	4890	13340		172										129
	16	5.556	5	4860	13280	55	211	87	16	72	34.5	69	I	15	M8×1P	9	121
	20		3	3140	8110		177										79
	10		5	5720	14490		153										131
	12		5	5710	14470		172										131
16	6.35	4	4520	11100	57	180	87	16	72	34.5	69	I	15	M8×1P	9	105	
20		3	3530	8340		178										80	

Note: Coam and Cam are the modified static and dynamic load capacities,calculated according to ISO-3408-5

FDDC

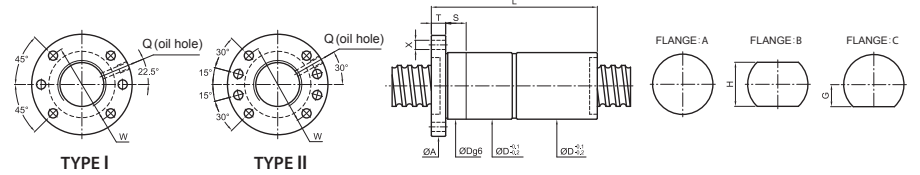

Unit: mm

SCREW SIZE		BALL DIA.	EFFECTIVE TURNS	MODIFIED LOAD CAPACITY (kgf)		NUT		FLANGE						FIT	OIL HOLE	BOLT	STIFFNESS
O.D.	LEAD			Dynamic (1×10 ⁶ REV.) Cam	Static Coam	Dg6	L	A	T	W	G	H	TYPE				
36	8	4.762	5	4170	12580	56	127	84	11	68	34	68	II	15	M8×1P	9	133
	10		5	6050	16460		153										142
	12		5	6080	16430		172										142
	16	6.35	5	6050	16360	61	213	91	18	76	34	68	II	15	M8×1P	9	142
	20		4	4910	12890		217										115
	36		2	2570	6250		194										59
	36		2	2570	6250		194										59
38	10		5	6260	17740		155										149
	12		5	6260	17410		172										149
	16	6.35	5	6220	17350	63	213	93	18	78	35	70	II	20	M8×1P	9	149
	40		3	3830	10220		282										106
40	5	3.175	4	1760	6260	60	87	91	18	76	34	68	II	15	M8×1P	9	111
	6	3.969	5	3420	11810	60	108	91	18	76	34	68	II	15	M8×1P	9	142
	8	4.762	4	3610	11260	62	118	91	18	76	34	68	II	15	M8×1P	9	118
	10		5	6430	18440		158										155
	12		5	6420	18410		172										155
	15	4.762	5	6380	18350	68	226	95	18	80	36	72	II	20	M8×1P	9	155
	16	6.35	5	6390	18330		212										155
	20		4	5190	14450		220										125
	40		2	2700	6950		210										64
	12		5	7530	20800		174										158
	16	7.144	5	7500	20730	70	212	98	18	83	37	74	II	20	M8×1P	11	158

Note: Coam and Cam are the modified static and dynamic load capacities,calculated according to ISO-3408-5

FDDC

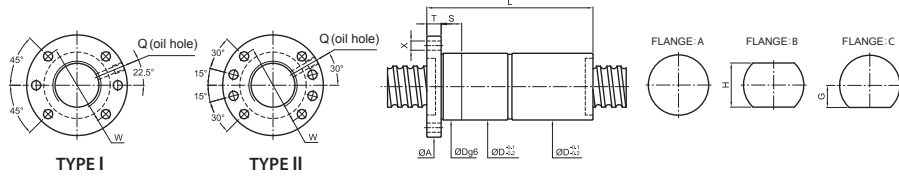

Unit: mm

SCREW SIZE	BALL DIA.	EFFECTIVE TURNS	MODIFIED LOAD CAPACITY (kgf)		NUT		FLANGE						FIT	OIL HOLE	BOLT	STIFFNESS	
			Dynamic (1×10 ⁶ REV.) Cam	Static Coam	Dg6	L	A	T	W	G	H	TYPE					S
45	8	4.762	4	3770	12580	66	114	98	18	83	37	74	II	20	M8×1P	11	130
	10		5	6910	21330		158										170
	12	6.35	5	6910	21310	70	171	105	18	88	40	80	II	20	M8×1P	11	170
	16		5	6880	21250		215										170
	20	7.144	4	6440	18340	73	220	105	18	88	40	80	II	20	M8×1P	11	139
50	5	3.175	5	2360	9950	75	98	105	18	88	40	80	II	20	M8×1P	11	164
	8	4.762	5	4780	17550	75	128	105	18	88	40	80	II	20	M8×1P	11	169
	10		5	7160	23320		158										185
	12	6.35	5	7150	23300	75	174	118	18	100							185
	16		5	7120	23250		215				46	92	II	20	M8×1P	11	185
	20		3	4460	13520	75	185	118	18	100							112
55	12	7.938	4	7810	22680	80	225	121	18	104	46	92	II	20	M8×1P	11	154
	16		5	7340	25280	80	180	118	18	100	46	92	II	20	M8×1P	11	198
63	10	6.35	5	7800	29210	88	164	135	22	115	50	100	II	20	M8×1P	14	220
	16	9.525	5	13640	43620	102	228	147	20	127	56	112		25			257
80	20		5	15350	56760		283										305
	25	9.525	4	12530	44860	118	296	165	25	145	65	130	II	25	M8×1P	14	245
	30		3	9610	32980		254										185

Note: Coam and Cam are the modified static and dynamic load capacities, calculated according to ISO-3408-5

External Ball Circulation Nuts

Features

- Lower noise due to longer ball circulation paths.
- Offers smoother ball circulation.
- Offers better solution and quality for high lead or large diameter ballscrews.

Type

There are two types of Ballnut of the external circulation Ballscrews. They are "immersion type" of Fig.2 and "extrusive type" of Fig.3 The "immersion type" means the ball circulation tubes are inside the circular surface of Ballnut as shown on specifications of this catalogue are of "immersion type".

In some cases, as per designs on customer's drawings, there are smaller outer diameters ballnuts required. Then the ball circulation tubes shall extrude out of Ballnut circular surface.

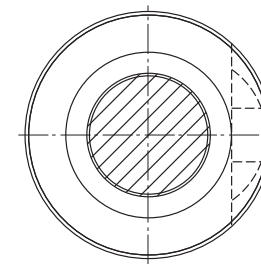

Fig.2 Immersion type

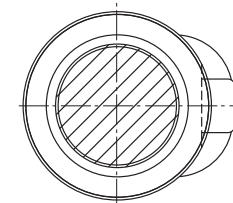
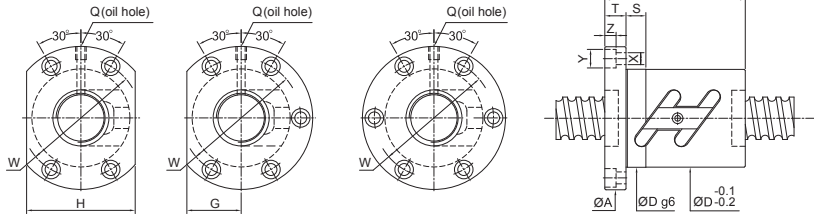

Fig.3 Extrusive type

FSWC



Unit:mm

SCREW SIZE		BALL DIA.	EFFECTIVE TURNS circuit × row	BASIC RATE LOAD (kgf)		NUT	FLANGE					FIT	BOLT	OIL HOLE	STIFFNESS				
O.D.	LEAD			Dynamic (1×10 ⁶ REV.) Ca	Static Co		Dg6	L	A	T	W					G	H	S	X
10	3	2.000	2.5×1	250	430	37											9		
	4	2.000	2.5×1	250	430	26	40	46	10	36	14	28	10	4.5	8	4.5	M6×1P	9	
	5	2.000	2.5×1	250	430	42												9	
12	4	2.381	2.5×1	380	640	40												12	
	5	2.381	2.5×1	380	640	30	40	50	10	40	16	32	10	4.5	8	4.5	M6×1P	12	
14	4	2.381	2.5×1	410	750	40												14	
	5	3.175	2.5×1	675	1145	34	42	57	11	45	17	34	10	5.5	9.5	5.5	M6×1P	15	
15	4	2.381	2.5×1	420	800	40												14	
	5	3.175	2.5×1	680	1210	34	42	57	10	45	17	34	10	5.5	9.5	5.5	M6×1P	15	
	10	3.175	2.5×1	680	1210	55												16	
16	4	2.381	1.5×2	490	1010	44												18	
			2.5×1	430	850	34	41	57	11	45	17	34	10	5.5	9.5	5.5	M6×1P	15	
			3.5×1	560	1180	42													21
	5	3.175	1.5×2	805	1525	45												19	
			2.5×1	690	1270	40	41	63	11	51	21	42	15	5.5	9.5	5.5	M6×1P	16	
6	3.175	2.5×2	1250	2540	56													31	
		3.5×1	920	1780	46													22	
		1.5×2	805	1525	52													19	
10	3.175	2.5×1	690	1270	40	44	63	11	51	21	42	15	5.5	9.5	5.5	M6×1P	16		
		3.5×1	920	1780	52													22	
		2.5×1	690	1270	40	56	63	11	51	21	42	15	5.5	9.5	5.5	M6×1P	16		
20	4	2.381	1.5×2	530	1270	44												21	
			2.5×1	480	1060	40	40	63.5	11	51	21	42	15	5.5	9.5	5.5	M6×1P	18	
			2.5×2	820	2120	40	50												35
			3.5×1	600	1480	43													25
	5	3.175	1.5×2	965	2070	45							15					24	
			2.5×1	830	1730	42							10	5.5	9.5	5.5	M6×1P	20	
			2.5×2	1510	3460	44	56	67	11	55	26	52	15					39	
6	3.969	3.5×1	1110	2420	46							15					26		
		1.5×2	1285	2545	56													24	
8	3.969	2.5×1	1100	2120	48	49	71	11	59	27	54	15	5.5	9.5	5.5	M6×1P	20		
		3.5×1	1470	2970	56													28	
10	3.969	1.5×2	1285	2545	61													24	
		2.5×1	1100	2120	48	54	75	13	61	27	54	15	6.6	11	6.5	M6×1P	20		
		3.5×1	1470	2970	62													28	

FSWC

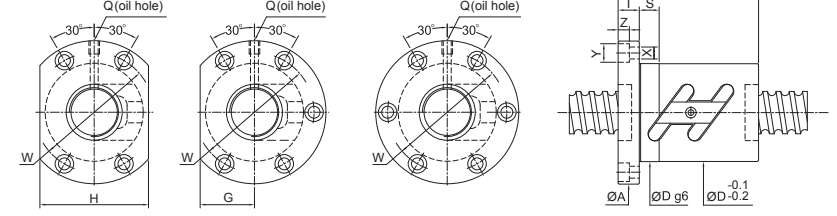

Unit:mm

SCREW SIZE		BALL DIA.	EFFECTIVE TURNS circuit × row	BASIC RATE LOAD (kgf)		NUT	FLANGE					FIT	BOLT	OIL HOLE	STIFFNESS			
O.D.	LEAD			Dynamic (1×10 ⁶ REV.) Ca	Static Co		Dg6	L	A	T	W					G	H	S
4	2.381	1.5×2	600	1630	44													26
		2.5×1	510	1355	46	40	69	11	57	26	52	15	5.5	9.5	5.5	M6×1P	22	
		2.5×2	930	2710	49													42
		3.5×1	680	1900	42													30
5	3.175	1.5×2	1065	2575	45													28
		2.5×1	910	2150	41	41	73	11	61	28	56	15	5.5	9.5	5.5	M6×1P	24	
		2.5×2	1650	4300	50	56												46
		3.5×1	1210	3010	46													33
6	3.969	1.5×2	1420	3215	56													29
		2.5×1	1210	2680	49	49	76	11	64	29	58	15	5.5	9.5	5.5	M6×1P	24	
		2.5×2	2190	5360	62	62												47
		3.5×1	1610	3750	56													34
8	4.762	1.5×2	1820	3840	61													30
		2.5×1	1560	3200	58	61	85	13	71	32	64	15	6.6	11	6.5	M6×1P	25	
		3.5×1	2080	4480	66													35
		1.5×2	1820	3840	71													30
10	4.762	2.5×1	1560	3200	58	65	85	15	71	32	64	15	6.6	11	6.5	M6×1P	25	
		3.5×1	2080	4480	75													35
12	3.969	2.5×1	1210	2680	53	60	76	11	64	32	64	15	5.5	9.5	5.5	M6×1P	24	
5	3.175	1.5×2	1110	2960	46													31
		2.5×1	950	2470	55	42	83	12	69	31	62	15	6.6	11	6.5	M8×1P	26	
		2.5×2	1720	4940	56	56												50
		3.5×1	1270	3460	47													36
6	3.969	1.5×2	1480	3605	57													32
		2.5×1	1270	3000	50	50	83	12	69	31	62	15	6.6	11	6.5	M8×1P	26	
		2.5×2	2300	6000	63	63												51
		3.5×1	1690	4200	57													37
8	4.762	1.5×2	1935	4325	65													33
		2.5×1	1650	3600	60	63	93	15	76	36	72	15	9	14	8.5	M8×1P	28	
10	4.762	3.5×1	2200	5040	68													38
		1.5×2	1935	4325	74													33
10	4.762	2.5×1	1650	3600	60	67	93	15	76	36	72	15	9	14	8.5	M8×1P	28	
		3.5×1	2200	5040	77													38

FSWC

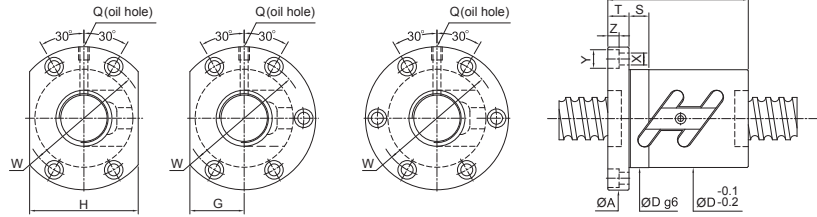

Unit:mm

SCREW SIZE		BALL DIA.	EFFECTIVE TURNS circuit x row	BASIC RATE LOAD (kgf)		NUT	FLANGE					FIT	BOLT	OIL HOLE	STIFFNESS					
O.D.	LEAD			Dynamic (1×10 ⁶ REV.) Ca	Static Co		Dg6	L	A	T	W					G	H	S	X	Y
32	4	2.381	2.5×1	565	1750	54	40	81	12	67	32	64	15	6.6	11	6.5	M6×1P	26		
			2.5×2	1020	3500													50	50	50
	5	3.175	1.5×2	1180	3410	47													34	
			2.5×1	1010	2840	43														29
			2.5×2	1830	5680	58	57	85	12	71	32	64	15	6.6	11	6.5	M8×1P	56		
			2.5×3	2590	8520	72														82
			3.5×1	1350	3980	47														40
	6	3.969	1.5×2	1560	4135	57													35	
			2.5×1	1330	3450	45														29
			2.5×2	2410	6900	62	63	88	12	75	34	68	15	6.6	11	6.5	M8×1P	57		
			3.5×1	1770	4830	57														40
	8	4.762	1.5×2	2010	5010	64													36	
2.5×1			1720	4180	63														30	
2.5×2			3120	8360	66	80	98	15	82	38	76	15	9	14	8.5	M8×1P	59			
10	6.35	1.5×2	3000	6530	78													38		
		2.5×1	2570	5440	68														32	
		2.5×2	4660	10880	74	97	108	15	90	41	82	15	9	14	8.5	M8×1P	61			
12	6.35	1.5×2	3000	6530	78													38		
		2.5×1	2570	5440	74	77	108	18	90	41	82	15	9	14	8.5	M8×1P	32			
		2.5×2	4660	10880	74	110	108	18	90	41	82	15	9	14	8.5	M8×1P	62			
36	5	3.175	1.5×2	1240	3850	50												38		
			2.5×2	1920	6420	65	60	98	15	82	38	76	15	9	14	8.5	M8×1P	62		
			2.5×3	2720	9630	75	75												90	
	6	3.969	1.5×2	1410	4490	50													44	
			2.5×2	2600	7900	65	66	98	15	82	38	76	15	9	14	8.5	M8×1P	63		
			2.5×3	3680	11850	84	84												93	
	10	6.35	1.5×2	3180	7410	81													41	
			2.5×1	2720	6180	75	71	118	18	98	45	90	15	11	17.5	11	M8×1P	35		
			2.5×2	4930	12360	75	103	118	18	98	45	90	15	11	17.5	11	M8×1P	68		
			3.5×1	3630	8650	81													48	
	12	6.35	1.5×2	2720	6180	77													35	
			2.5×2	4930	12360	75	110	118	18	98	45	90	15	11	17.5	11	M8×1P	68		
3.5×1			3630	8650	91	91												48		

FSWC

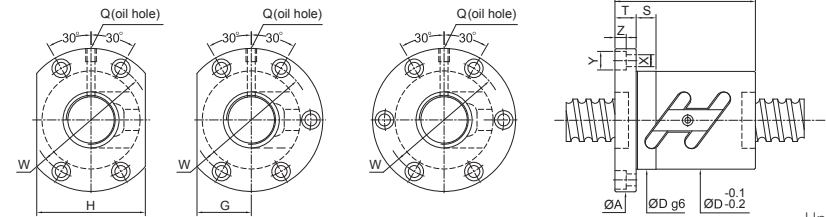

Unit:mm

SCREW SIZE		BALL DIA.	EFFECTIVE TURNS circuit x row	BASIC RATE LOAD (kgf)		NUT	FLANGE					FIT	BOLT	OIL HOLE	STIFFNESS				
O.D.	LEAD			Dynamic (1×10 ⁶ REV.) Ca	Static Co		Dg6	L	A	T	W					G	H	S	X
40	5	3.175	1.5×2	1280	4275	50												41	
			2.5×1	1090	3560	48													34
			2.5×2	1980	7120	67	60	101	15	83	39	78	15	9	14	8.5	M8×1P	66	
			2.5×3	2800	10680	75													98
			3.5×1	1450	4980	50													47
	6	3.969	1.5×2	1750	5300	60													42
			2.5×1	1500	4420	53													35
			2.5×2	2720	8840	70	66	104	15	86	40	80	15	9	14	8.5	PT1/8"	69	
	8	4.762	1.5×2	3850	13260	84													101
			2.5×3	2000	6190	60													49
			1.5×2	2220	6320	64													43
			2.5×1	1900	5270	63	74	108	15	90	41	82	15	9	14	8.5	PT1/8"	36	
10	6.35	2.5×2	3450	10540	83													70	
		3.5×1	2540	7380	68													50	
		1.5×2	3370	8335	81													45	
12	6.35	2.5×1	2880	6950	71													35	
		2.5×2	5220	13900	82	103	124	18	102	47	94	20	11	17.5	11	PT1/8"	74		
		3.5×1	3840	9730	81													52	
45	10	6.35	2.5×1	2880	6950	77												38	
			2.5×2	5220	13900	86	112	128	18	106	48	96	20	11	17.5	11	PT1/8"	74	
			3.5×1	3840	9730	91													52
	12	7.144	2.5×2	5480	15700	88	101	132	18	110	50	100	20	11	17.5	11	PT1/8"	81	
			2.5×3	7760	23550	131													119
12	7.144	2.5×1	3550	8950	84													43	
		2.5×2	6440	17900	90	112	132	18	110	50	100	20	11	17.5	11	PT1/8"	82		
			2.5×3	9120	26850	148												121	

FSWC

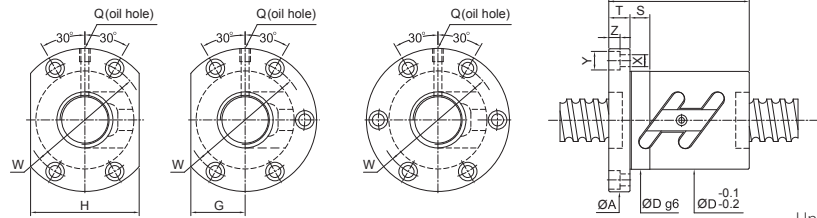

Unit:mm

SCREW SIZE	BALL DIA.	EFFECTIVE TURNS circuit x row	BASIC RATE LOAD (kgf)		NUT	FLANGE					FIT				BOLT	OIL HOLE	STIFFNESS		
			Dynamic (1×10 ⁶ REV.) Ca	Static Co		Dg6	L	A	T	W	G	H	S	X				Y	Z
50	5	3.175	1.5×2	1410	5305	50												49	
			1.5×3	2000	7960	80	60	114	15	96	43	86	15	9	14	8.5	PT1/8"	72	
			2.5×2	2190	8840	60													80
			3.5×1	1610	6190	50													57
	6	3.969	1.5×2	1920	6600	60												50	
			2.5×2	2980	11000	84	67	118	15	100	45	90	15	9	14	8.5	PT1/8"	82	
			2.5×3	4220	16500	85													121
			3.5×1	2190	7700	60													58
	8	4.762	1.5×2	2515	7810	68												52	
			2.5×2	3900	13020	87	86	128	18	107	49	98	20	11	17.5	11	PT1/8"	85	
			2.5×3	5520	19530	109													125
			3.5×1	2870	9110	71													60
10	6.35	1.5×2	3725	10450	81												54		
		2.5×1	3190	8710	71													45	
		2.5×2	5790	17420	93	101	135	18	113	51	102	20	11	17.5	11	PT1/8"	88		
		2.5×3	8200	26130	131													130	
12	7.144	3.5×1	4260	12190	81												63		
		2.5×1	3700	10050	88	146	22	122	55	110	20	14	20	13	PT1/8"	46			
55	10	6.35	2.5×2	6005	19540	101											95		
			2.5×3	8510	29310	131	144	18	122	54	108	20	11	17.5	11	PT1/8"	140		
63	10	6.35	2.5×1	3510	11200	75											55		
			2.5×2	6370	22400	108	105	154	22	130	58	116	20	14	20	13	PT1/8"	106	
			2.5×3	9020	33600	135												156	
12	7.938	2.5×1	4770	13780	88												59		
			2.5×2	8650	27560	115	124	161	22	137	61	122	20	14	20	13	PT1/8"	113	
80	10	6.35	2.5×3	12250	41340	160											167		
			2.5×2	7130	28500	105	176	22	152	66	132	20	14	20	13	PT1/8"	129		
16	9.525	2.5×3	10100	42750	134												190		
			2.5×2	9710	35560	124	182	22	158	68	136	20	14	20	13	PT1/8"	137		
80	7.938	2.5×3	13760	53340	160												202		
			2.5×2	16450	59280	160	204	28	172	77	154	30	18	26	17.5	PT1/8"	170		
80	16	9.525	2.5×3	23300	88920	208											250		

FDWC

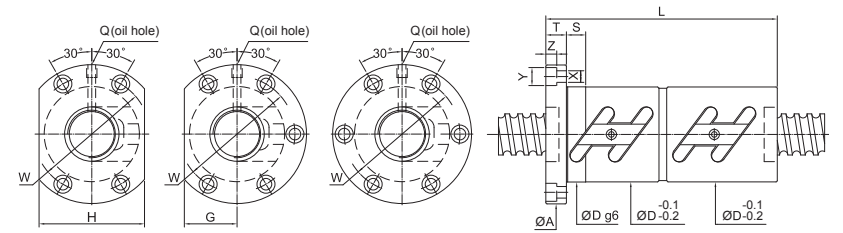

Unit:mm

SCREW SIZE	BALL DIA.	EFFECTIVE TURNS circuit x row	BASIC RATE LOAD (kgf)		NUT	FLANGE					FIT				BOLT	OIL HOLE	STIFFNESS		
			Dynamic (1×10 ⁶ REV.) Ca	Static Co		Dg6	L	A	T	W	G	H	S	X				Y	Z
16	4	2.381	1.5×2	490	1010	81												36	
			2.5×1	430	850	34	70	57	11	45	17	34	15	5.5	9.5	5.5	M6×1P	30	
			3.5×1	560	1180	78													42
			1.5×2	805	1525	90													39
	5	3.175	2.5×1	690	1270	40	77	63	11	51	20	40	15	5.5	9.5	5.5	M6×1P	33	
			2.5×2	1250	2540	105													63
			3.5×1	920	1780	88													45
			1.5×2	805	1525	90													39
	6	3.175	2.5×1	690	1270	40	80	63	11	51	20	40	15	5.5	9.5	5.5	M6×1P	33	
			3.5×1	920	1780	90													45
			1.5×2	530	1270	83													42
			2.5×1	480	1060	40	67	63	11	51	24	48	15	5.5	9.5	5.5	M6×1P	36	
20	4	2.381	2.5×2	820	2120	89												69	
			3.5×1	600	1480	75												49	
			1.5×2	965	2070	99													47
			2.5×1	830	1730	76													40
	5	3.175	2.5×2	1510	3460	44	105	67	11	55	26	52	15	5.5	9.5	5.5	M6×1P	40	
			3.5×1	1110	2420	80													77
			1.5×2	1285	2545	98													49
			2.5×1	1100	2120	48	82	71	11	59	27	54	15	5.5	9.5	5.5	M6×1P	41	
8	3.969	3.5×1	1470	2970	93												45		
		1.5×2	1285	2545	108													49	
		2.5×2	1100	2120	48	102	75	13	61	28	56	15	6.6	11	6.5	M6×1P	41		
		3.5×1	1470	2970	110													56	

FDWC

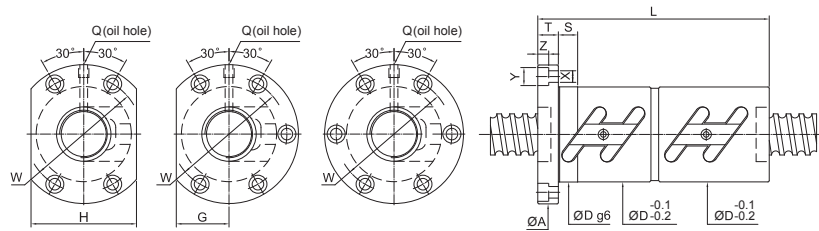

Unit:mm

SCREW SIZE		BALL DIA.	EFFECTIVE TURNS circuit x row	BASIC RATE LOAD (kgf)		NUT Dg6	FLANGE							FIT S	BOLT X	OIL HOLE Y	Z	Q	STIFFNESS kgf/4m
O.D.	LEAD			Dynamic (1x10 ⁶ REV.) Ca	Static Co		L	A	T	W	G	H	S						
25	4	2.381	1.5x2	600	1630	83												51	
			2.5x1	510	1355	67												43	
			2.5x2	930	2710	91	69	11	57	26	52	15	5.5	9.5	5.5	M6x1P			84
			3.5x1	680	1900	75													59
	5	3.175	1.5x2	1065	2575	80												57	
			2.5x1	910	2150	77												48	
			2.5x2	1650	4300	105	73	11	61	28	56	15	5.5	9.5	5.5	M6x1P			92
			3.5x1	1210	3010	86													65
	6	3.969	1.5x2	1420	3215	91												58	
			2.5x1	1210	2680	82												49	
			2.5x2	2190	5360	116	76	11	64	29	58	15	5.5	9.5	5.5	M6x1P			94
			3.5x1	1610	3750	93													67
8	4.762	1.5x2	1820	3840	111												60		
		2.5x1	1560	3200	95												50		
		3.5x1	2080	4480	111													69	
		1.5x2	1820	3840	134													60	
10	4.762	2.5x1	1560	3200	85												50		
		3.5x1	2080	4480	138												69		
		1.5x2	1110	2960	86												62		
		2.5x1	950	2470	78												52		
28	5	3.175	2.5x2	1720	4940	106	83	12	69	31	62	15	6.6	11	6.5	M8x1P		101	
			3.5x1	1270	3460	86												72	
			1.5x2	1480	3605	98												63	
			2.5x1	1270	3000	89												53	
	6	3.969	2.5x2	2300	6000	117	83	12	69	31	62	15	6.6	11	6.5	M8x1P		103	
			3.5x1	1690	4200	94												73	
			1.5x2	1935	4325	113												66	
			2.5x1	1650	3600	97												55	
	8	4.762	3.5x1	2200	5040	113												76	
			1.5x2	1935	4325	134												66	
			2.5x1	1635	3600	93												55	
			3.5x1	2200	5040	138												76	
10	4.762	1.5x2	1935	4325	134											66			
		2.5x1	1635	3600	93											55			
		3.5x1	2200	5040	138											76			
		1.5x2	1110	2960	86											62			

FDWC

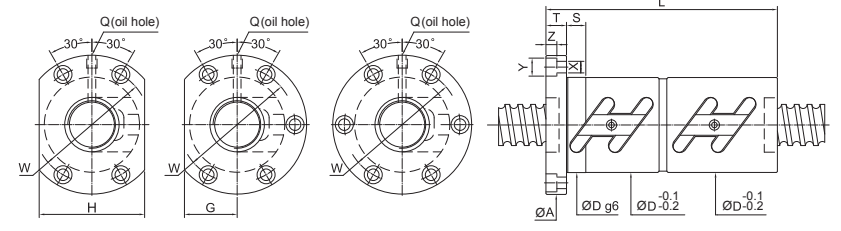

Unit:mm

SCREW SIZE		BALL DIA.	EFFECTIVE TURNS circuit x row	BASIC RATE LOAD (kgf)		NUT Dg6	FLANGE							FIT S	BOLT X	OIL HOLE Y	Z	Q	STIFFNESS kgf/4m
O.D.	LEAD			Dynamic (1x10 ⁶ REV.) Ca	Static Co		L	A	T	W	G	H	S						
32	4	2.381	2.5x1	565	1750	54												52	
			2.5x2	1020	3500	90												101	
			1.5x2	1180	3410	82												69	
			2.5x1	1010	2840	78												58	
	5	3.175	2.5x2	1830	5680	58												112	
			2.5x3	2590	8520	136											164		
			3.5x1	1350	3980	82											80		
			1.5x2	1560	4135	100											70		
	6	3.969	2.5x1	1330	3450	62											59		
			2.5x2	2410	6900	123											114		
			3.5x1	1770	4830	100											81		
			1.5x2	2010	5010	113											76		
8	4.762	2.5x1	1720	4180	106											64			
		2.5x2	3120	8360	152											123			
		3.5x1	2300	5850	113											88			
		1.5x2	3000	6530	138											76			
10	6.35	2.5x1	2570	5440	118											64			
		2.5x2	4660	10880	177											123			
		3.5x1	3430	7620	148											88			
		1.5x2	3000	6530	160											76			
12	6.35	2.5x1	2570	5440	137											64			
		2.5x2	4660	10880	208											124			
		3.5x1	3430	7620	160											88			
		1.5x2	3000	6530	160											76			
36	5	3.175	2.5x2	1240	3850	91										75			
			2.5x3	1920	6420	110										123			
			2.5x1	2720	9630	139										181			
			3.5x1	1410	4490	90										87			
	6	3.969	2.5x2	2600	7900	123										126			
			2.5x3	3680	11850	159										187			
			2.5x1	3265	9450	153										129			
			3.5x1	2360	8650	151										96			
	8	4.762	1.5x2	3180	7410	141										83			
			2.5x1	2720	6180	131										70			
			2.5x2	4930	12360	180										136			
			3.5x1	3630	8650	151										96			
10	6.35	2.5x1	2720	6180	137										70				
		2.5x2	4930	12360	208										136				
		3.5x1	3630	8650	151										96				
		1.5x2	3180	7410	141										83				
12	6.35	2.5x1	2720	6180	137										70				
		2.5x2	4930	12360	208										136				
		3.5x1	3630	8650	161										97				
		1.5x2	3180	7410	141										83				

FDWC

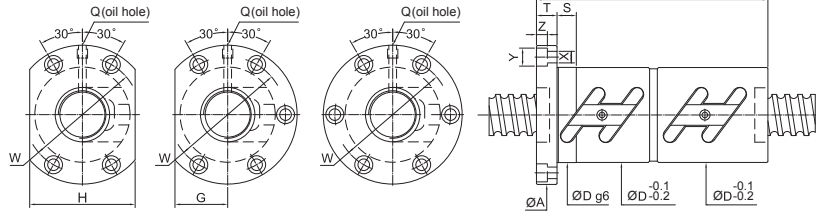

Unit:mm

SCREW SIZE		BALL DIA.	EFFECTIVE TURNS circuit x row	BASIC RATE LOAD (kgf)		NUT	FLANGE						FIT	BOLT	OIL HOLE	STIFFNESS			
O.D.	LEAD			Dynamic (1×10 ⁶ REV.) Ca	Static Co		Dg6	L	A	T	W	G					H	S	X
40	5	3.175	1.5×2	1280	4275	88												82	
			2.5×1	1090	3560	84													69
			2.5×2	1980	7120	67	108	101	15	83	39	78	15	9	14	8.5	M8×1P		133
			2.5×3	2800	10680	139													196
			3.5×1	1450	4980	88													95
	6	3.969	1.5×2	1750	5300	103												85	
			2.5×1	1500	4420	90												71	
			2.5×2	2720	8840	70	123	104	15	86	40	80	15	9	14	8.5	PT1/8"		138
			2.5×3	3850	13260	159													202
			3.5×1	2000	6190	103													98
	8	4.762	1.5×2	2220	6320	124												86	
			2.5×1	1900	5270	108												73	
2.5×2			3450	10540	74	108	15	90	41	82	15	9	14	8.5	PT1/8"		141		
3.5×1			2540	7380	125													100	
1.5×2			3370	8335	141													91	
10	6.35	2.5×1	2880	6950	131												71		
		2.5×2	5220	13900	82	180	124	18	102	47	94	20	11	17.5	11	PT1/8"	148		
		3.5×1	3840	9730	151												105		
12	6.35	2.5×1	2880	6950	137												76		
		2.5×2	5220	13900	86	208	128	18	106	48	96	20	11	17.5	11	PT1/8"	148		
		3.5×1	3840	9730	161												105		
45	6	3.969	2.5×2	2850	9870	80	123	114	15	96	48	96	15	9	14	8.5	PT1/8"	151	
			2.5×3	4035	14800	159												222	
	8	4.762	2.5×2	3650	11780	158												155	
			2.5×3	5175	17670	206												228	
	10	6.35	2.5×2	5480	15700	180												163	
2.5×3			7760	23550	243												239		
12	7.144	2.5×1	3550	8950	140												85		
		2.5×2	6440	17900	210												165		

FDWC

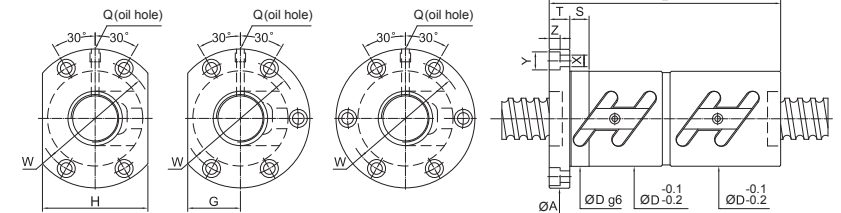

Unit:mm

SCREW SIZE		BALL DIA.	EFFECTIVE TURNS circuit x row	BASIC RATE LOAD (kgf)		NUT	FLANGE						FIT	BOLT	OIL HOLE	STIFFNESS			
O.D.	LEAD			Dynamic (1×10 ⁶ REV.) Ca	Static Co		Dg6	L	A	T	W	G					H	S	X
50	5	3.175	1.5×2	1410	5305	108												98	
			1.5×3	2000	7960	80	128	114	15	96	43	86	15	9	14	8.5	PT1/8"	144	
			2.5×2	2190	8840	113													159
			2.5×3	1610	6190	108													114
			3.5×1	1920	6600	111													101
	6	3.969	1.5×2	2980	11000	84	123	118	15	100	45	90	15	9	14	8.5	PT1/8"	164	
			2.5×3	4220	16500	159													242
			3.5×1	2190	7700	107													117
			1.5×2	2515	7810	127													104
			2.5×2	3900	13020	87	156	128	18	107	49	98	20	11	17.5	11	PT1/8"	170	
	8	4.762	2.5×3	5520	19530	208												250	
			3.5×1	2870	9110	127												121	
1.5×2			3725	10450	151													108	
2.5×1			3190	8710	132													91	
2.5×2			5790	17420	93	180	135	18	113	51	102	20	11	17.5	11	PT1/8"	177		
10	6.35	2.5×3	8200	26130	243												261		
		3.5×1	4260	12190	151												126		
		2.5×1	3700	10050	140												92		
12	7.144	2.5×2	6710	20100	100	210	146	18	122	55	110	20	14	20	13	PT1/8"	179		
		2.5×3	6005	19540	102	181	144	18	122	54	108	20	11	17.5	11	PT1/8"	191		
55	10	6.35	2.5×3	8510	29310	243											281		
			2.5×1	3510	11200	136												110	
63	10	6.35	2.5×2	6370	22400	108	189	154	22	130	58	116	20	14	20	13	PT1/8"	213	
			2.5×3	9020	33600	249												313	
	12	7.938	2.5×1	4760	13820	144	161	22	137	61	122	20	14	20	13	PT1/8"	112		
16	9.525	2.5×2	8650	27560	115	214											218		
		2.5×1	8050	23100	122	200	178	28	150	69	138	20	18	26	17.5	PT1/8"	144		
		2.5×2	14600	46200	296												280		
80	10	6.35	2.5×2	7130	28500	130	189	176	22	152	66	132	20	14	20	13	PT1/8"	258	
			2.5×3	10100	42750	249	249											380	
	12	7.938	2.5×2	9710	35560	136	220	182	22	158	68	136	20	14	20	13	PT1/8"	265	
			2.5×3	13760	53340	292	292											391	
	16	9.525	2.5×2	16450	59280	143	290	204	28	172	77	154	30	18	26	17.5	PT1/8"	339	
2.5×3			23300	88920	386	386											500		

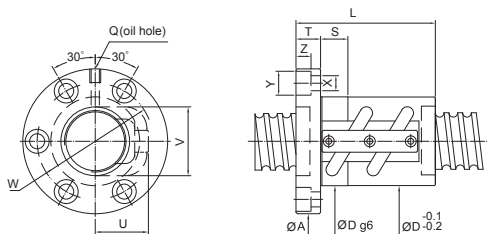

Unit:mm

SCREW SIZE	O.D.	LEAD	BALL DIA.	EFFECTIVE TURNS circuit × row	BASIC RATE LOAD (kgf)		NUT	FLANGE				FIT				BOLT		RETURN TUBE	OIL HOLE	STIFFNESS	
					Dynamic (1×10 ⁶ REV.) Ca	Static Co		Dg6	L	A	T	W	S	X	Y	Z	U				V
14	4	2.381	2.5×1	2.5×1	410	750	25	40	45	10	35	10	5.5	9.5	5.5	19	21	M6×1P	14		
	5	3.175	2.5×1	2.5×1	675	1145	25	42	45	10	35	10	5.5	9.5	5.5	19	21	M6×1P	15		
15	4	2.381	2.5×1	2.5×1	420	800	28.5	40	48	10	38	10	5.5	9.5	5.5	17	22	M6×1P	14		
	5	3.175	2.5×1	2.5×1	680	1210	28.5	42	48	10	38	10	5.5	9.5	5.5	17	22	M6×1P	15		
16	5	3.175	1.5×2	805	1525	50														19	
			2.5×1	690	1270	31	45	54	12	41	15	5.5	9.5	5.5	20	23	M6×1P	16			
			2.5×2	1250	2540	60															31
20	5	3.175	3.5×1	920	1780	50														22	
			1.5×2	965	2070	50															24
			2.5×1	830	1730	35	45	58	12	46	15	5.5	9.5	5.5	22	27	M6×1P	20			
25	6	3.969	2.5×2	1510	3460	60														39	
			3.5×1	1110	2420	50															26
			1.5×2	1285	2545	66															24
28	6	3.969	2.5×1	1100	2120	36	48	60	12	47	15	5.5	9.5	5.5	23	28	M6×1P	20			
			3.5×1	1470	2970	66														28	
			1.5×2	1420	3215	65															29
32	10	4.762	2.5×1	1210	2680	42	50	68	12	55	15	5.5	9.5	5.5	28	33	M6×1P	24			
			2.5×2	2190	5360	68														47	
			3.5×1	1610	3750	65														34	
36	10	6.35	1.5×2	1820	3840	75														30	
			2.5×1	1560	3200	45	65	72	16	58	15	6.6	11	6.5	29	35	M6×1P	25			
			3.5×1	2080	4480	75														35	
40	5	3.175	1.5×2	1110	2960	50														31	
			2.5×1	950	2470	44	45	70	12	56	15	6.6	11	6.5	28	35	M6×1P	26			
			2.5×2	1720	4940	60														50	
45	6	3.969	3.5×1	1270	3460	50														36	
			1.5×2	1480	3605	55															32
			2.5×1	1270	3000	44	50	70	12	56	15	6.6	11	6.5	28	36	M6×1P	26			
50	6	3.969	2.5×2	2300	6000	68														51	
			3.5×1	1690	4200	55															37

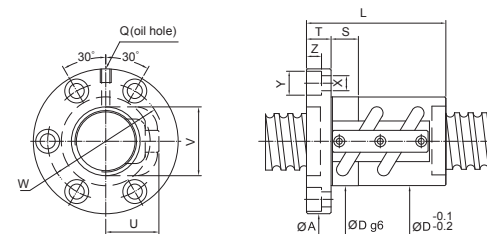

Unit:mm

SCREW SIZE	O.D.	LEAD	BALL DIA.	EFFECTIVE TURNS circuit × row	BASIC RATE LOAD (kgf)		NUT	FLANGE				FIT				BOLT		RETURN TUBE	OIL HOLE	STIFFNESS	
					Dynamic (1×10 ⁶ REV.) Ca	Static Co		Dg6	L	A	T	W	S	X	Y	Z	U				V
32	5	3.175	1.5×2	1180	3410	50														34	
			2.5×1	1010	2840	45															29
			2.5×2	1830	5680	50	60	76	12	63	15	6.6	11	6.5	30	39	M6×1P	56			
			2.5×3	2590	8520	75															82
			3.5×1	1350	3980	50															40
			1.5×2	1560	4135	55															
36	6	3.969	2.5×1	1330	3450	52	50	68	12	65	15	6.6	11	6.5	32	40	M6×1P	29			
			2.5×2	2410	6900	68														57	
			3.5×1	1770	4830	55														40	
			1.5×2	2010	5010	70															36
			2.5×1	1720	4180	54	62	88	16	70	15	9	14	8.5	33	42	M6×1P	30			
			2.5×2	3120	8360	86															59
40	10	6.35	3.5×1	2300	5850	70														42	
			1.5×2	3000	6530	78															38
			2.5×1	2570	5440	68	68	91	16	73	15	9	14	8.5	37	45	M8×1P	32			
			2.5×2	4660	10880	98															61
			3.5×1	3430	7620	78															44
			1.5×2	1430	3950	50															33
45	6	3.969	2.5×2	2600	7900	55	68	82	12	68	15	6.6	11	6.5	32	45	M6×1P	63			
			1.5×2	3180	7410	82														41	
			2.5×1	2720	6180	62	72	104	18	82	20	11	17.5	11	40	49	M6×1P	35			
			2.5×2	4930	12360	102														68	
			3.5×1	3630	8650	82														48	

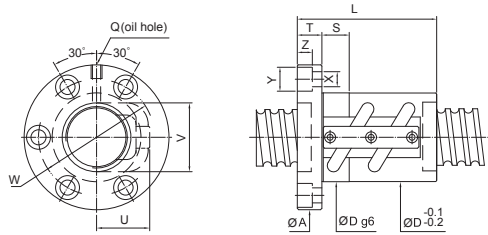

Unit:mm

SCREW SIZE		BALL DIA.	EFFECTIVE TURNS circuit × row	BASIC RATE LOAD (kgf)		NUT		FLANGE			FIT			BOLT			RETURN TUBE	OIL HOLE	STIFFNESS kgf/μm	
O.D.	LEAD			Dynamic (1×10 ⁶ REV.) Ca	Static Co	Dg6	L	A	T	W	S	X	Y	Z	U	V	Q			
40	5	3.175	1.5×2	1280	4270	55													41	
			2.5×1	1090	3560	50														34
			2.5×2	1980	7120	58	65	92	16	72	15	9	14	8.5	34	47	M8×1P			66
			2.5×3	2800	10680	80														98
			3.5×1	1450	4980	55														47
	6	3.969	1.5×2	1750	5300	60													42	
			2.5×1	1500	4420	54													35	
			2.5×2	2720	8840	60	72	94	16	76	15	9	14	8.5	36	48	PT1/8"			69
			2.5×3	3850	13260	90														101
			3.5×1	2000	6190	60														49
	8	4.762	1.5×2	2220	6320	70													43	
			2.5×1	1900	5270	62													36	
2.5×2			3450	10540	62	86	96	16	78	15	9	14	8.5	38	50	PT1/8"			70	
2.5×3			2540	7380	70														50	
3.5×1			2220	6320	70														43	
10	6.35	1.5×2	3370	8335	82													45		
		2.5×1	2880	6950	72													35		
		2.5×2	5220	13900	65	102	106	18	85	20	11	17.5	11	42	52	PT1/8"			74	
		3.5×1	3840	9730	82														52	
10	6.35	2.5×1	3020	7850	74													42		
		2.5×2	5480	15700	70	104	112	18	90	20	11	17.5	11	48	58	PT1/8"			81	
12	7.144	2.5×1	3550	8950	74													43		
		2.5×2	6440	17900	74	123	122	18	97	20	14	20	13	49	60	PT1/8"			82	

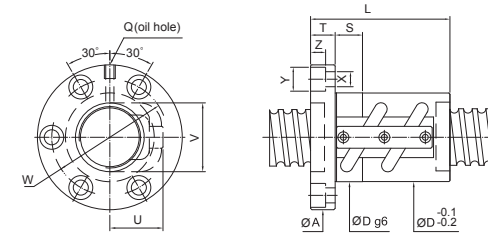

Unit:mm

SCREW SIZE		BALL DIA.	EFFECTIVE TURNS circuit × row	BASIC RATE LOAD (kgf)		NUT		FLANGE			FIT			BOLT			RETURN TUBE	OIL HOLE	STIFFNESS kgf/μm		
O.D.	LEAD			Dynamic (1×10 ⁶ REV.) Ca	Static Co	Dg6	L	A	T	W	S	X	Y	Z	U	V	Q				
50	5	3.175	1.5×2	1410	5305	63													49		
			1.5×3	2000	7960	70	73	104	16	86	15	9	14	8.5	40	57	PT1/8"			72	
			3.5×1	1610	6190	63														57	
			2.5×2	2980	11000	72	75	106	16	88	15	9	14	8.5	43	59	PT1/8"			82	
			2.5×3	4220	16500	93														121	
	6	3.969	2.5×2	2980	11000	72	75	106	16	88	15	9	14	8.5	43	59	PT1/8"			82	
			2.5×3	4220	16500	93														121	
			2.5×2	3900	13020	75	88	116	18	95	20	11	17.5	11	45	60	PT1/8"			85	
			2.5×3	5520	19530	112														125	
			3.5×1	2000	6190	60														49	
	8	4.762	1.5×2	3725	10450	84													54		
			2.5×1	3190	8710	74													45		
2.5×2			5790	17420	78	104	119	18	98	20	11	17.5	11	48	62	PT1/8"			88		
2.5×3			8200	26130	134														130		
3.5×1			4260	12190	84														63		
10	6.35	2.5×2	5790	17420	78	104	119	18	98	20	11	17.5	11	48	62	PT1/8"			88		
		2.5×3	8200	26130	134														130		
		3.5×1	4260	12190	84														63		
12	7.144	2.5×1	3700	10050	82	87	128	22	105	20	14	20	13	52	64	PT1/8"			46		
		2.5×2	6710	20100	123														89		
55	10	6.35	2.5×2	6005	19540	84	100	125	18	103	20	11	17.5	11	54	68	PT1/8"			95	
			2.5×3	8150	29310	130														140	
			3.5×1	3510	11200	77														55	
63	10	6.35	2.5×2	6370	22400	90	107	132	20	110	20	11	17.5	11	53	76	PT1/8"			106	
			2.5×3	9020	33600	137														156	
			2.5×1	4770	13780	88														59	
			2.5×2	8650	27560	94	124	142	22	117	20	14	20	13	57	76	PT1/8"			113	
			2.5×3	12250	41340	160															167
16	9.525	2.5×1	8050	23100	100	105	150	22	123	20	14	20	13	62	79	PT1/8"			72		
		2.5×2	14600	46200	153														140		
		3.5×1	3510	11200	77														55		
80	10	6.35	2.5×2	7130	28500	115	109	163	22	137	20	14	20	13	64	91	PT1/8"			129	
			2.5×3	10100	42750	139														190	
			2.5×2	9710	35560	125	125	169	22	143	25	14	20	13	67	94	PT1/8"			137	
			2.5×3	13760	53340	159															202
			3.5×1	16450	59280	125	156	190	28	154	25	18	26	17.5	70	96	PT1/8"			170	
16	9.525	2.5×3	23300	88920	204														250		

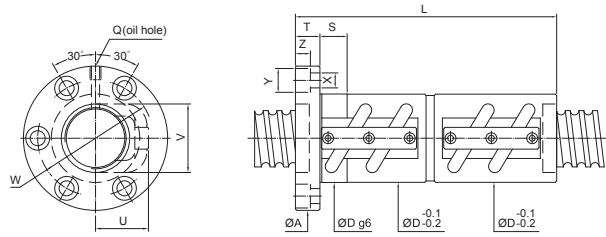

Unit:mm

SCREW SIZE		BALL DIA.	EFFECTIVE TURNS circuit × row	BASIC RATE LOAD (kgf)		NUT	FLANGE	FIT	BOLT	RETURN TUBE	OIL HOLE	STIFFNESS								
O.D.	LEAD			Dynamic (1×10 ⁶ REV.) Ca	Static Co								Dg6	L	A	T	W	S	X	Y
16	5	3.175	1.5×2	805	1525	90												39		
			2.5×1	690	1270	31	80												33	
			2.5×2	1250	2540	110	54	12	41	15	5.5	9.5	5.5	20	23			M6×1P	63	
			3.5×1	920	1780	90														45
20	5	3.175	1.5×2	965	2070	90												47		
			2.5×1	830	1730	35	80												40	
			2.5×2	1510	3460	110	58	12	46	15	5.5	9.5	5.5	22	27			M6×1P	77	
			3.5×1	1110	2420	90														55
25	6	3.969	1.5×2	1285	2545	104												49		
			2.5×1	1100	2120	36	92	60	12	47	15	5.5	9.5	5.5	23	28		M6×1P	41	
			3.5×1	1470	2970	104														56
			1.5×2	1065	2575	90														57
25	5	3.175	2.5×1	910	2150	40	80											48		
			2.5×2	1650	4300	110	64	12	52	15	5.5	9.5	5.5	25	32		M6×1P	92		
			3.5×1	1210	3010	90														65
			1.5×2	1420	3215	104														58
25	6	3.969	2.5×1	1210	2680	92												49		
			2.5×2	2190	5360	128	68	12	55	15	5.5	9.5	5.5	28	33		M6×1P	94		
			3.5×1	1610	3750	104														67
			1.5×2	1820	3840	136														60
28	10	4.762	2.5×1	1560	3200	45	122	72	16	58	15	6.6	11	6.5	29	35		M6×1P	50	
			3.5×1	2080	4480	136														69
			1.5×2	1110	2960	90														62
			2.5×1	950	2470	44	80													52
28	5	3.175	2.5×2	1720	4940	110	70	12	56	15	6.6	11	6.5	28	35		M6×1P	101		
			3.5×1	1270	3460	90														72
			1.5×2	1480	3605	110														63
			2.5×1	1270	3000	44	98													53
28	6	3.969	2.5×2	2300	6000	134	70	12	56	15	6.6	11	6.5	28	36		M6×1P	103		
			3.5×1	1690	4200	110														73

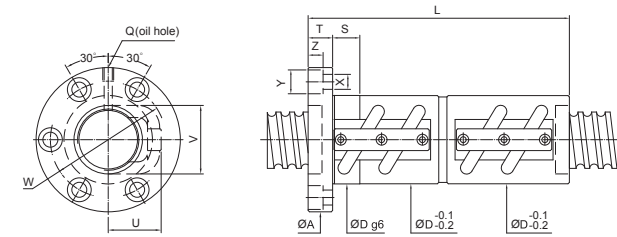

Unit:mm

SCREW SIZE		BALL DIA.	EFFECTIVE TURNS circuit × row	BASIC RATE LOAD (kgf)		NUT	FLANGE	FIT	BOLT	RETURN TUBE	OIL HOLE	STIFFNESS								
O.D.	LEAD			Dynamic (1×10 ⁶ REV.) Ca	Static Co								Dg6	L	A	T	W	S	X	Y
32	5	3.175	1.5×2	1180	3410	90												69		
			2.5×1	1010	2840	80													58	
			2.5×2	1830	5680	50	110	76	12	63	15	6.6	11	6.5	30	39		M6×1P	112	
			2.5×3	2590	8520	140														164
			3.5×1	1350	3980	90														80
32	6	3.969	1.5×2	1560	4135	104												70		
			2.5×1	1330	3450	52	92												59	
			2.5×2	2410	6900	128	78	12	65	15	6.6	11	6.5	32	40		M6×1P	114		
			3.5×1	1770	4830	104														81
32	8	4.762	1.5×2	2010	5010	126												73		
			2.5×1	1720	4180	54	110												61	
			2.5×2	3120	8360	158	88	16	70	15	9	14	8.5	33	42		M6×1P	118		
			3.5×1	2300	5850	126														84
32	10	6.35	1.5×2	3000	6530	142												76		
			2.5×1	2570	5440	57	122												64	
			2.5×2	4660	10880	182	91	16	73	15	9	14	8.5	37	45		M8×1P	123		
36	6	3.969	3.5×1	3430	7620	142												88		
			2.5×1	1430	3950	55	92												65	
			2.5×2	2600	7900	128	82	12	68	15	6.6	11	6.5	32	45		M6×1P	126		
36	10	6.35	1.5×2	3180	7410	144												83		
			2.5×1	2720	6180	62	124												70	
			2.5×2	4930	12360	184	104	18	82	20	11	17.5	11	40	49		M6×1P	136		
			3.5×1	3630	8650	144														90

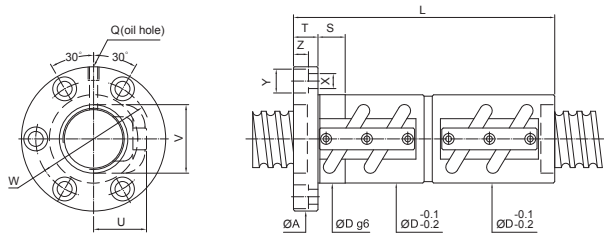

Unit:mm

SCREW SIZE		BALL DIA.	EFFECTIVE TURNS circuit x row	BASIC RATE LOAD (kgf)		NUT	FLANGE				FIT				BOLT				RETURN TUBE	OIL HOLE	STIFFNESS
O.D.	LEAD			Dynamic (1×10 ⁶ REV.) Ca	Static Co		Dg6	L	A	T	W	S	X	Y	Z	U	V	Q			
40	5	3.175	1.5×2	1280	4275	94													82		
			2.5×1	1090	3560	84														69	
			2.5×2	1980	7120	58	114	92	16	72	15	9	14	8.5	34	47	M8×1P			133	
			2.5×3	2800	10680	144														196	
			3.5×1	1450	4980	94														95	
	6	3.969	1.5×2	1750	5300	108													85		
			2.5×1	1500	4420	96													71		
			2.5×2	2720	8840	60	132	94	16	76	15	9	14	8.5	36	48	PT1/8"			138	
			2.5×3	3850	13260	168														202	
			3.5×1	2000	6190	108														98	
	8	4.762	1.5×2	2220	6320	126													86		
			2.5×1	1900	5270	110													73		
2.5×2			3450	10540	62	158	96	16	78	15	9	14	8.5	38	50	PT1/8"			141		
3.5×1			2540	7380	126														100		
1.5×2			3370	8335	152														91		
10	6.35	2.5×1	2880	6950	132													71			
		2.5×2	5220	13900	65	192	106	18	85	20	11	17.5	11	42	52	PT1/8"			148		
		3.5×1	3840	9730	152													105			
45	10	6.35	2.5×1	3020	7850	134												84			
			2.5×2	5480	15700	70	194	112	18	90	20	11	17.5	11	48	58	PT1/8"			163	
	12	7.144	2.5×1	3550	8950	158												85			
			2.5×2	6440	17900	74	230	122	18	97	20	14	20	13	49	60	PT1/8"			165	

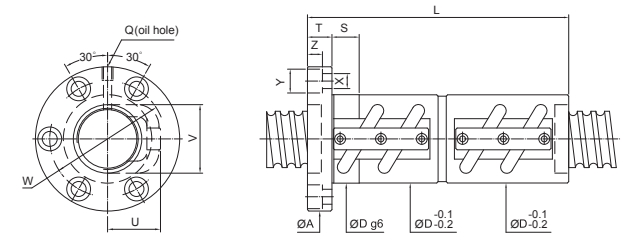

Unit:mm

SCREW SIZE		BALL DIA.	EFFECTIVE TURNS circuit x row	BASIC RATE LOAD (kgf)		NUT	FLANGE				FIT				BOLT				RETURN TUBE	OIL HOLE	STIFFNESS
O.D.	LEAD			Dynamic (1×10 ⁶ REV.) Ca	Static Co		Dg6	L	A	T	W	S	X	Y	Z	U	V	Q			
50	5	3.175	1.5×2	1410	5305	107													98		
			1.5×3	2000	7960	70	127	104	16	86	15	9	14	8.5	40	57	PT1/8"			144	
			3.5×1	1610	6190	107														114	
	6	3.969	2.5×2	2980	11000	72	134	106	16	88	15	9	14	8.5	43	59	PT1/8"			164	
			2.5×3	4220	16500	170														242	
			2.5×2	3900	13020	75	160	116	18	95	20	11	17.5	11	45	60	PT1/8"			170	
	8	4.762	2.5×3	5520	19530	208													250		
			1.5×2	3725	10450	154													119		
			2.5×1	3190	8710	134													91		
	10	6.35	2.5×2	5790	17420	78	194	119	18	98	20	11	17.5	11	48	62	PT1/8"			177	
			2.5×3	8200	26130	254													261		
			3.5×1	4260	12190	154													126		
12	7.144	2.5×1	3700	10050	82	160	128	22	105	20	14	20	13	52	64	PT1/8"			92		
		2.5×2	6710	20100	232														179		
		2.5×2	6005	19540	84	194	125	18	103	20	11	17.5	11	54	68	PT1/8"			191		
55	10	6.35	2.5×3	8510	29310	254												281			
			2.5×1	3510	11200	136													110		
			2.5×2	6370	22400	90	196	132	20	110	20	11	17.5	11	53	76	PT1/8"			213	
63	10	6.35	2.5×3	9020	33600	256												313			
			2.5×1	4760	13820	160													112		
			2.5×2	8650	27560	94	232	142	22	117	20	14	20	13	57	76	PT1/8"			218	
16	9.525	2.5×3	12250	41340	304													322			
		2.5×1	8050	23100	100	200	150	22	123	20	14	20	13	62	79	PT1/8"			144		
		2.5×2	14600	46200	296													280			
80	10	6.35	2.5×2	7130	28500	115	200	163	22	137	20	14	20	13	64	91	PT1/8"			258	
			2.5×3	10100	42750	260													380		
			2.5×2	9710	35560	120	232	169	22	143	25	14	20	13	67	94	PT1/8"			265	
12	7.938	9.525	2.5×3	13760	53340	302												391			
			2.5×2	16450	59280	125	302	190	28	154	25	18	26	17.5	70	96	PT1/8"			339	
			2.5×3	23300	88920	398													500		

High Lead Ballscrews

High-lead Ballscrews are essential elements and parts for high-speed machine tools of next century.

Features

It is important for a High-lead Ballscrew to be with characteristics of high rigidity, low noise and thermal control. *PMI's* designs and treatments are taken for following:

High DN Value

The DN value can be 130,000 in normal case. For some special cases, for example in a fixed ends case, the DN value can be as high as 140,000. Please contact our engineers for this special application.

High Speed

PMI's High-speed Ballscrews provide 100 *m/min* and even higher traverse speed for machine tools for high performance cutting.

High Rigidity

Both the screw and ballnut are surface hardened to a specific hardness and case depth to maintain high rigidity and durability.

Multiple thread starts are available to make more steel balls loaded in the ballnut for higher rigidity and durability.

Low Noise

Special design of ball circulation tubes offer smooth ball circulation inside the ballnut. It also makes safe ball fast running into the tubes without damaging the tubes.

Accurate ball circle diameter (BCD) through whole threads for consistent drag torque and low noise.

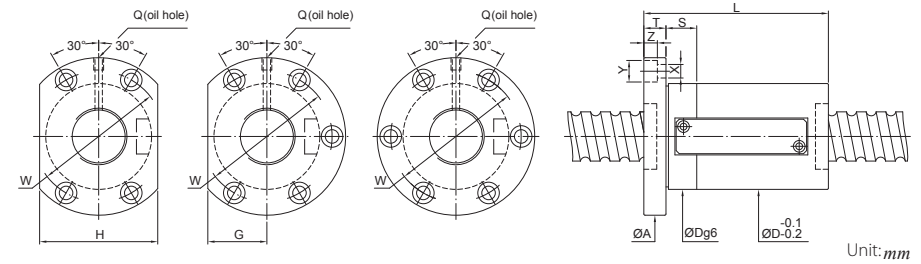

SCREW SIZE		BALL DIA.	EFFECTIVE TURNS circuit x row	BASIC RATE LOAD (kgf)		NUT		FLANGE				FIT		BOLT		OIL HOLE	STIFFNESS	
O.D.	LEAD			Dynamic (1×10 ⁶ REV.) Ca	Static Co	Dg6	L	A	T	W	G	H	S	X	Y	Z	Q	kgf/μm
12	10	2.381	2.5×1	420	720	30	50	50	10	40	16	32	10	4.5	8	4.4	M6×1P	20
	10	3.969	2.5×1	1210	2380	46	63	73.5	13	59	25	50	10	5.5	9.5	5.5	M6×1P	34
	16	3.969	3.5×1	1580	3230	46	73	73.5	13	59	25	50	10	5.5	9.5	5.5	M6×1P	45
20	16	3.969	1.5×1	830	1530	46	63	73.5	13	59	25	50	10	5.5	9.5	5.5	M6×1P	24
	20	3.969	2.5×1	1210	2380	46	79	73.5	13	59	25	50	10	5.5	9.5	5.5	M6×1P	34
	20	3.969	1.5×1	830	1530	46	70	73	13	59	25	50	10	5.5	9.5	5.5	M6×1P	24
25	16	3.969	1.5×1	920	1930	58	68	85	15	71	32	64	15	6.6	11	6.5	M6×1P	28
	20	4.762	2.5×1	1710	3580	58	94	85	15	71	32	64	15	6.6	11	6.5	M6×1P	42
	20	4.762	3.5×1	2220	4860	58	114	85	15	71	32	64	15	6.6	11	6.5	M6×1P	55
32	16	3.969	1.5×1	1010	2480	62	83	108	15	90	41	82	15	9	14	8.5	M8×1P	33
	16	3.969	2.5×1	1470	3860	62	99	108	15	90	41	82	15	9	14	8.5	M8×1P	48
	16	3.969	3.5×1	1910	5240	62	114	108	15	90	41	82	15	9	14	8.5	M8×1P	63
	16	3.969	5×1	2340	6620	62	144	108	15	90	41	82	15	9	14	8.5	M8×1P	77
	16	6.35	2.5×1	2830	6090	74	92	108	18	88	41	82	15	11	17.5	11	M8×1P	54
	16	6.35	3.5×1	3680	8270	74	104	108	18	88	41	82	15	11	17.5	11	M8×1P	69
32	20	3.969	1.5×1	1010	2480	74	94	108	18	88	41	82	15	11	17.5	11	M8×1P	33
	20	3.969	2.5×1	1470	3860	74	114	108	18	88	41	82	15	11	17.5	11	M8×1P	48
	20	3.969	3.5×1	1910	5240	74	144	108	18	88	41	82	15	11	17.5	11	M8×1P	63
32	20	6.35	5×1	2340	6610	74	174	108	18	88	41	82	15	11	17.5	11	M8×1P	77
	20	6.35	2.5×1	2830	6090	74	104	108	18	88	41	82	15	11	17.5	11	M8×1P	54
32	20	6.35	3.5×1	3680	8270	74	124	108	18	88	41	82	15	11	17.5	11	M8×1P	69
32	20	6.35	5×1	4490	10450	74	144	108	18	88	41	82	15	11	17.5	11	M8×1P	85

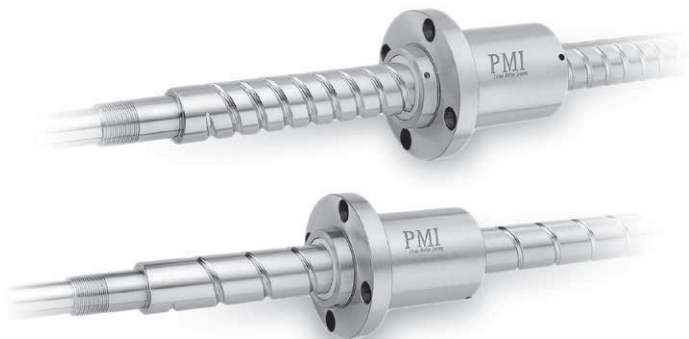

FSWE

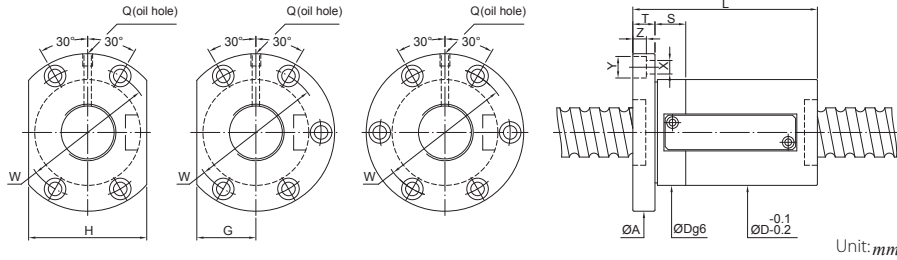

SCREW SIZE		BALL DIA.	EFFECTIVE TURNS circuit × row	BASIC RATE LOAD (kgf)		NUT		FLANGE					FIT		BOLT		OIL HOLE	STIFFNESS	
O.D.	LEAD			Dynamic (1×10 ⁶ REV.) Ca	Static Co	Dg6	L	A	T	W	G	H	S	X	Y	Z	Q	kgf/4m	
36	10	6.35	3.5×1	3890	9390	75	84	118	18	98	45	90	15	11	17.5	11	M8×1P	76	
			5×1	4750	11860	94	94												93
	12	6.35	2.5×1	2990	6920	85												58	
			3.5×1	3890	9390	75	97	118	18	98	45	90	15	11	17.5	11	M8×1P	76	
	16	6.35	5×1	4750	11860	109												93	
			2.5×1	2990	6920	91												58	
	20	6.35	3.5×1	3890	9390	75	107	118	18	98	45	90	15	11	17.5	11	M8×1P	76	
			5×1	4750	11860	123												93	
			1.5×1	2050	4450	91												41	
			2.5×1	2990	6920	111	118	18	98	45	90	15	11	17.5	11	PT1/8"	58		
	40	10	6.35	3.5×1	4130	10560	86	86	128	18	106	49	98	15	11	17.5	11	PT1/8"	82
				5×1	5050	13340	96	96											101
12		6.35	2.5×1	3180	7780	86												63	
			3.5×1	4130	10560	86	98	128	18	106	49	98	15	11	17.5	11	PT1/8"	82	
16		6.35	5×1	5050	13340	110												101	
			2.5×1	3180	7780	92												63	
20		6.35	3.5×1	4130	10560	86	108	128	18	106	49	98	15	11	17.5	11	PT1/8"	82	
			5×1	5050	13340	124												101	
			2.5×1	3740	8790	92												65	
			3.5×1	4870	11930	86	108	128	18	106	49	98	15	11	17.5	11	PT1/8"	84	
40		6.35	5×1	5950	15070	124												103	
			1.5×1	2180	5000	84												43	
	2.5×1		3180	7780	104	128	18	106	49	98	15	11	17.5	11	PT1/8"	63			
	3.5×1		4130	10560	124												82		
40	6.35	5×1	5050	13340	144												101		
		1.5×1	2180	5000	86	130	128	18	106	49	98	15	11	17.5	11	PT1/8"	43		

FSWE

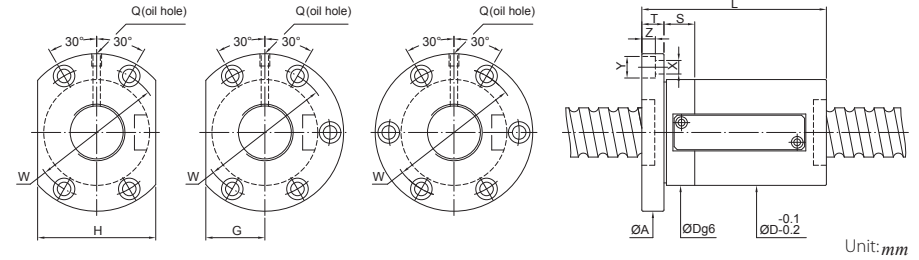

SCREW SIZE		BALL DIA.	EFFECTIVE TURNS circuit × row	BASIC RATE LOAD (kgf)		NUT		FLANGE					FIT		BOLT		OIL HOLE	STIFFNESS
O.D.	LEAD			Dynamic (1×10 ⁶ REV.) Ca	Static Co	Dg6	L	A	T	W	G	H	S	X	Y	Z	Q	kgf/4m
50	10	6.35	3.5×1	4560	13230	93	85	135	18	113	51	102	20	11	17.5	11	PT1/8"	97
			5×1	5580	16710	95	95											119
	12	6.35	2.5×1	3510	9750	80												74
			3.5×1	4560	13230	93	92	135	18	113	51	102	20	11	17.5	11	PT1/8"	97
	16	6.35	5×1	5580	16710	104												119
			2.5×1	4080	11260	93												75
	20	6.35	3.5×1	5300	15280	100	105	146	25	122	55	110	20	14	20	13	PT1/8"	99
			5×1	6480	19300	117												121
			2.5×1	3510	9750	94												74
			3.5×1	4560	13230	93	110	135	18	113	51	102	20	11	17.5	11	PT1/8"	97
	50	16	7.144	5×1	5580	16710	126											119
				2.5×1	4080	11260	100											
20		7.144	3.5×1	5300	15280	100	116	146	25	122	55	110	15	14	20	13	PT1/8"	99
			5×1	6480	19300	132												121
20		7.938	1.5×1	2790	7240	104												52
			2.5×1	4080	11260	124	146	25	122	55	110	15	14	20	13	PT1/8"	75	
50		7.938	3.5×1	5300	15280	144												99
			5×1	6480	19300	164												121
20		7.938	2.5×1	4750	12090	119												78
			3.5×1	6180	16400	105	139	152	25	128	58	116	20	14	20	13	PT1/8"	101
50		7.938	5×1	7550	20720	159												124
			1.5×1	3250	7770	105	157	152	25	128	58	116	20	14	20	13	PT1/8"	53

FSWE

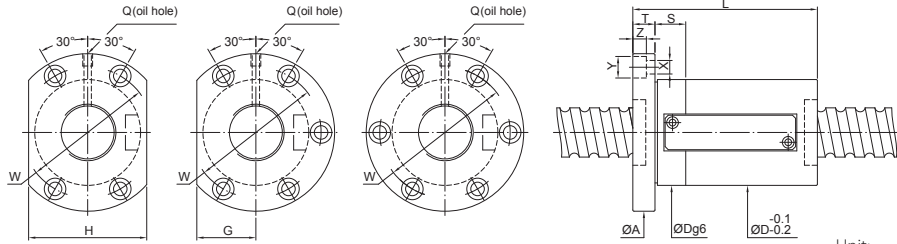

Unit:mm

SCREW SIZE		BALL DIA.	EFFECTIVE TURNS circuit x row	BASIC RATE LOAD (kgf)		NUT		FLANGE						FIT		BOLT		OIL HOLE	STIFFNESS
O.D.	LEAD			Dynamic (1×10 ⁶ REV.) Ca	Static Co	Dg6	L	A	T	W	G	H	S	X	Y	Z	Q		
63	10	6.35	3.5×1 5×1	5030	17020	108	86 96	154	22	130	58	116	20	14	20	13	PT1/8"	115	
				6150	21500													141	
	12	6.35	3.5×1 5×1	3870	12540	108	96	154	22	130	58	116	20	14	20	13	PT1/8"	87	
				5030	17020													115	
	12	7.144	3.5×1 5×1	4540	14460	115	102	161	22	137	61	122	20	14	20	13	PT1/8"	89	
				5900	19620													117	
	16	7.144	3.5×1 5×1	4540	14460	115	113	161	22	137	61	122	20	14	20	13	PT1/8"	89	
				5900	19620													117	
	16	7.938	3.5×1 5×1	5260	15430	120	128	180	28	150	72	144	25	18	26	17.5	PT1/8"	91	
				6840	20940													120	
	20	6.35	3.5×1 5×1	3870	12540	108	124	154	22	130	58	116	20	14	20	13	PT1/8"	87	
				5030	17020													115	
20	9.525	3.5×1 5×1	8870	25870	122	140	182	28	150	72	144	25	18	26	17.5	PT1/8"	105		
			11530	35110													136		
80	10	6.35	3.5×1 5×1	5630	21660	130	90	176	22	152	66	132	20	14	20	13	PT1/8"	133	
				6880	27360													164	
	12	7.938	3.5×1 5×1	7670	27030	136	101 113	182	22	158	68	136	20	14	20	13	PT1/8"	143	
				9380	34140													177	
	16	9.525	3.5×1 5×1	9900	33200	143	124	204	28	172	77	154	30	18	26	17.5	PT1/8"	124	
				12990	45050													162	
20	9.525	3.5×1 5×1	15880	56910	140	140	204	28	172	77	154	30	18	26	17.5	PT1/8"	201		
			9900	33200													124		
20	9.525	3.5×1 5×1	12990	45050	143	140	204	28	172	77	154	30	18	26	17.5	PT1/8"	162		
			15880	56910													201		
100	16	9.525	2.5×1 3.5×1 5×1	11320	41820	170	131	243	32	205	91	182	30	22	32	21.5	PT1/8"	139	
				14720	56750													182	
	20	9.525	2.5×1 3.5×1 5×1	11320	41820	170	128	148	243	32	205	91	182	30	22	32	21.5	PT1/8"	139
				14720	56750														182
20	9.525	3.5×1 5×1	17990	71690	168	147	168	22	179	77	154	30	18	26	17.5	PT1/8"	226		
			11320	41820													139		
20	9.525	3.5×1 5×1	17990	71690	168	128	148	243	32	205	91	182	30	22	32	21.5	PT1/8"	226	
			11320	41820														139	

FDWE

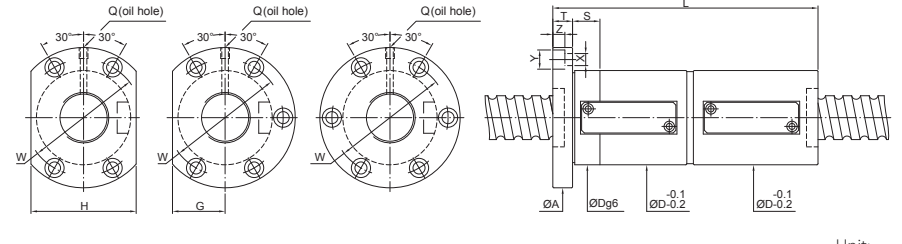

Unit:mm

SCREW SIZE		BALL DIA.	EFFECTIVE TURNS circuit x row	BASIC RATE LOAD (kgf)		NUT		FLANGE						FIT		BOLT		OIL HOLE	STIFFNESS
O.D.	LEAD			Dynamic (1×10 ⁶ REV.) Ca	Static Co	Dg6	L	A	T	W	G	H	S	X	Y	Z	Q		
12	10	2.381	2.5×1	420	720	30	102	50	10	40	16	32	10	4.5	8	4.4	M6×1P	30	
				1210	2380													46	113
20	16	3.969	1.5×1 2.5×1	830	1530	46	128 160	73.5	13	59	25	50	10	5.5	9.5	5.5	M6×1P	35	
				1210	2380													51	
20	3.969	1.5×1	830	1530	46	130	73	13	59	25	50	10	5.5	9.5	5.5	M6×1P	35		
				830	1530	46	130	73	13	59	25	50	10	5.5	9.5	5.5	M6×1P	35	
25	16	3.969	1.5×1 2.5×1	920	1930	58	126 158	85	15	71	32	64	15	6.6	11	6.5	M6×1P	41	
				1340	3000													61	
25	20	4.762	2.5×1 3.5×1	1170	2300	58	194 234	85	15	71	32	64	15	6.6	11	6.5	M6×1P	43	
				1710	3580													63	
25	20	4.762	2.5×1 3.5×1	2220	4860	58	194 234	85	15	71	32	64	15	6.6	11	6.5	M6×1P	83	
				2220	4860													83	
32	16	3.969	1.5×1 2.5×1 3.5×1 5×1	1010	2480	62	164 196	108	15	90	41	82	15	9	14	8.5	M8×1P	49	
				1470	3860													73	
32	16	3.969	2.5×1 3.5×1 5×1	1910	5240	62	174 214	108	15	90	41	82	15	11	17.5	11	M8×1P	96	
				2340	6610													120	
32	16	6.35	2.5×1 3.5×1 5×1	2830	6090	74	205 237	108	18	90	41	82	15	11	17.5	11	M8×1P	80	
				3680	8270													105	
32	16	6.35	2.5×1 3.5×1 5×1	4490	10450	74	244 284	108	18	88	41	82	15	11	17.5	11	M8×1P	131	
				3680	8270													105	
32	20	3.969	1.5×1 2.5×1 3.5×1 5×1	1010	2480	62	174 214	108	15	90	41	82	15	9	14	8.5	M8×1P	49	
				1470	3860													73	
32	20	3.969	2.5×1 3.5×1 5×1	1910	5240	62	174 214	108	15	90	41	82	15	9	14	8.5	M8×1P	96	
				2340	6610													120	
32	20	6.35	2.5×1 3.5×1 5×1	2830	6090	74	244 284	108	18	88	41	82	15	11	17.5	11	M8×1P	80	
				3680	8270													105	
32	20	6.35	3.5×1 5×1	4490	10450	74	244 284	108	18	88	41	82	15	11	17.5	11	M8×1P	131	
				3680	8270													105	

FDWE

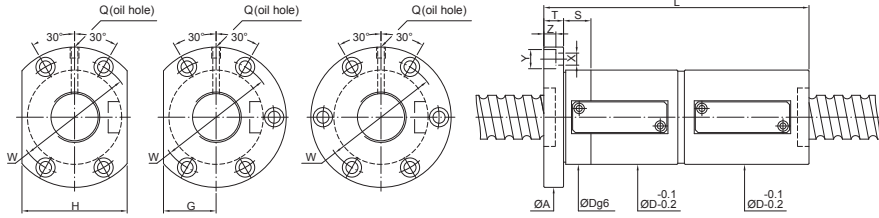

Unit:mm

SCREW SIZE		BALL DIA.	EFFECTIVE TURNS circuit x row	BASIC RATE LOAD (kgf)		NUT		FLANGE					FIT			BOLT		OIL HOLE	STIFFNESS													
O.D.	LEAD			Dynamic (1×10 ⁶ REV.) Ca	Static Co	Dg6	L	A	T	W	G	H	S	X	Y	Z	Q	kgf/µm														
36	10	6.35	3.5×1	3890	9390	75	155	118	18	98	45	90	15	11	17.5	11	M8×1P	115														
			5×1	4750	11860													143														
	12	6.35	2.5×1	2990	6920	140													88													
			3.5×1	3890	9390														75	164	118	18	98	45	90	15	11	17.5	11	M8×1P	115	
	16	6.35	5×1	4750	11860	188														143												
			2.5×1	2990	6920															171												
	20	6.35	3.5×1	5×1	4750	11860	75	203	118	18	98	45	90	15	11	17.5	11	M8×1P	115													
				1.5×1	2050	4450													235													59
2.5×1				2990	6920	204													118	18	98	45	90	15	11	17.5	11	PT1/8"				88
3.5×1				3890	9390	244																										
40	10	6.35	3.5×1	4130	10560	86	155	128	18	106	49	98	15	11	17.5	11	PT1/8"	125														
			5×1	5050	13340													175													155	
	12	6.35	2.5×1	3180	7780	141														95												
			3.5×1	4130	10560															86	165	128	18	106	49	98	15	11	17.5	11	PT1/8"	125
	16	6.35	5×1	5050	13340	189															155											
			2.5×1	3180	7780																173											
	20	6.35	3.5×1	4130	10560	86	205	128	18	106	49	98	15	11	17.5	11	PT1/8"				125											
			5×1	5050	13340																237											
	16	7.144	3.5×1	2.5×1	3740	8790	173														98											
				5×1	5950	15070															237											
	20	6.35	3.5×1	5×1	5950	15070	237														128											
				1.5×1	2180	5000															143	128	18	106	49	98	15	11	17.5	11	PT1/8"	
40	6.35	1.5×1	2.5×1	3180	7780	86	183	128	18	106	49	98	15	11	17.5	11	PT1/8"			95												
			3.5×1	4130	10560															223												
40	6.35	1.5×1	5×1	5050	13340	263														155												
			2.5×1	3180	7780															173												
40	6.35	1.5×1	2180	5000	86	242	128	18	106	49	98	15	11	17.5	11	PT1/8"				64												

FDWE

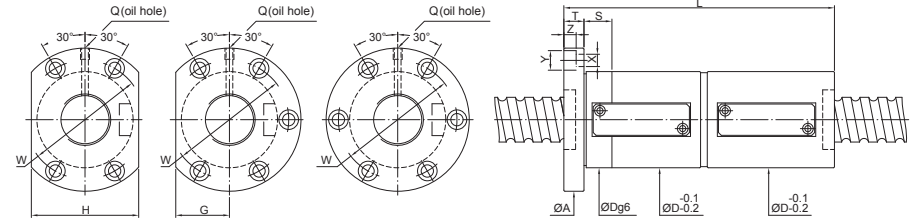

Unit:mm

SCREW SIZE		BALL DIA.	EFFECTIVE TURNS circuit x row	BASIC RATE LOAD (kgf)		NUT		FLANGE					FIT			BOLT		OIL HOLE	STIFFNESS		
O.D.	LEAD			Dynamic (1×10 ⁶ REV.) Ca	Static Co	Dg6	L	A	T	W	G	H	S	X	Y	Z	Q	kgf/µm			
50	10	6.35	3.5×1	4560	13230	93	155	135	18	113	51	102	20	11	17.5	11	PT1/8"	149			
			5×1	5580	16710													175			
	12	6.35	2.5×1	3510	9750	141														112	
			3.5×1	4560	13230															93	165
	16	6.35	5×1	5580	16710	189															185
			2.5×1	4080	11260																161
	20	7.144	3.5×1	5×1	6480	19300	209														187
				2.5×1	3510	9750															174
16	6.35	3.5×1	5×1	5580	16710	238														149	
			2.5×1	4080	11260															173	135
20	7.144	3.5×1	5×1	6480	19300	237														187	
			1.5×1	2790	7240															172	
20	7.144	2.5×1	3.5×1	4080	11260	100	204	146	25	122	55	110	15	14	20	13	PT1/8"			114	
			5×1	5300	15280															244	
20	7.938	3.5×1	5×1	6480	19300	284														187	
			2.5×1	4750	12090															219	
50	7.938	1.5×1	5×1	7550	20720	299														191	
			3.5×1	6180	16400															105	259
50	7.938	1.5×1	3250	7770	105	305	152	25	128	58	116	20	14	20	13	PT1/8"				79	

FDWE

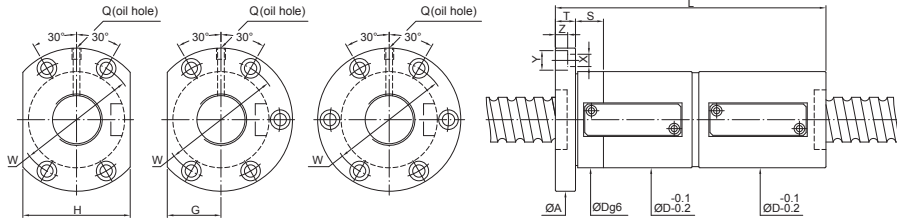

Unit:mm

SCREW SIZE		BALL DIA.	EFFECTIVE TURNS circuit x row	BASIC RATE LOAD (kgf)		NUT		FLANGE				FIT		BOLT		OIL HOLE	STIFFNESS		
O.D.	LEAD			Dynamic (1×10 ⁶ REV.) Ca	Static Co	Dg6	L	A	T	W	G	H	S	X	Y			Z	Q
63	10	6.35	3.5×1 5×1	5030	17020	108	155	154	22	130	58	116	20	14	20	13	PT1/8"	178	
				6150	21500													175	220
	12	6.35	3.5×1 5×1	3870	12540	108	153	154	22	130	58	116	20	14	20	13	PT1/8"	134	
				5030	17020													177	178
	12	7.144	3.5×1 5×1	4540	14460	115	158	182	161	22	137	61	122	20	14	20	13	PT1/8"	136
				5900	19620														206
	16	7.144	3.5×1 5×1	4540	14460	115	177	209	161	22	137	61	122	20	14	20	13	PT1/8"	180
				5900	19620														241
	16	7.938	3.5×1 5×1	5260	15430	120	207	239	180	28	150	72	144	25	18	26	17.5	PT1/8"	139
				6840	20940														271
	20	6.35	3.5×1 5×1	3870	12540	108	205	245	154	22	130	58	116	20	14	20	13	PT1/8"	134
				5030	17020														285
20	9.525	3.5×1 5×1	8870	25870	122	219	259	182	28	150	72	144	25	18	26	17.5	PT1/8"	158	
			11530	35110														299	208
80	10	6.35	3.5×1 5×1	5630	21660	130	159	176	22	152	66	132	20	14	20	13	PT1/8"	207	
				6880	27360													179	256
	12	7.938	3.5×1 5×1	7670	27030	136	184	182	22	158	68	136	20	14	20	13	PT1/8"	222	
				9380	34140													208	275
	16	9.525	3.5×1 5×1	9900	33200	143	188	220	204	28	172	77	154	30	18	26	17.5	PT1/8"	189
				12990	45050														252
20	9.525	3.5×1 5×1	12990	45050	143	252	260	204	28	172	77	154	30	18	26	17.5	PT1/8"	311	
			15880	56910														300	311
100	16	9.525	3.5×1 5×1	11320	41820	170	211	243	243	32	205	91	182	30	22	32	21.5	PT1/8"	213
				14720	56750														275
	20	9.525	3.5×1 5×1	11320	41820	170	228	268	243	32	205	91	182	30	22	32	21.5	PT1/8"	213
				14720	56750														308
				17990	71690														351

FSVE

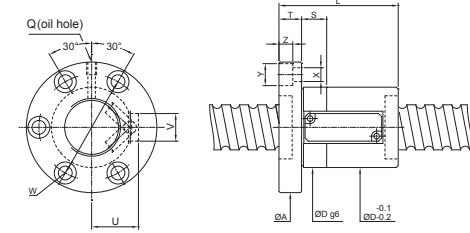

Unit:mm

SCREW SIZE		BALL DIA.	EFFECTIVE TURNS circuit x row	BASIC RATE LOAD (kgf)		NUT		FLANGE				FIT		BOLT		RETURN TUBE	OIL HOLE	STIFFNESS	
O.D.	LEAD			Dynamic (1×10 ⁶ REV.) Ca	Static Co	Dg6	L	A	T	W	S	X	Y	Z	U				V
12	10	2.381	2.5×1	420	720	25	50	48	10	36	10	4.5	8	4.4	14	12	M6×1P	20	
				1210	2380													38	63
20	10	3.969	3.5×1	1580	3230	38	73	62	13	50	10	5.5	9.5	5.5	23	15	M6×1P	34	
				830	1530													63	73
20	16	3.969	1.5×1	830	1530	38	63	62	13	50	10	5.5	9.5	5.5	23	15	M6×1P	24	
				1210	2380													79	73
20	3.969	1.5×1	830	1530	1530	38	70	62	13	50	10	5.5	9.5	5.5	23	15	M6×1P	24	
				830	1530													84	73
25	16	3.969	1.5×1	920	1930	42	68	68	15	55	15	6.5	11	6.6	26	14	M6×1P	28	
				1340	3000													84	73
25	20	4.762	2.5×1	1170	2300	44	94	72	15	59	15	6.6	11	6.5	28	14	M6×1P	29	
				1710	3580													114	73
25	20	4.762	3.5×1	2220	4860	44	114	72	15	59	15	6.6	11	6.5	28	14	M6×1P	55	
				1010	2480													67	73
16	3.969	1.5×1	1010	2480	2480	49	83	78	15	63	15	6.6	11	6.5	30	16	M8×1P	33	
				1470	3860													99	73
16	3.969	1.5×1	1470	3860	3860	49	99	78	15	63	15	6.6	11	6.5	30	16	M8×1P	48	
				1910	5240													115	73
16	6.35	3.5×1	2340	6610	6610	57	104	115	108	98	18	77	20	11	17.5	11	34	22	77
				2830	6090														92
16	6.35	3.5×1	2830	6090	6090	57	104	92	108	98	18	77	20	11	17.5	11	34	22	54
				3680	8270														124
16	9.525	3.5×1	4490	10450	10450	57	124	144	108	98	18	77	20	11	17.5	11	34	22	85
				1010	2480														74
20	3.969	1.5×1	1010	2480	2480	49	94	78	15	63	15	6.6	11	6.5	30	16	M8×1P	33	
				1470	3860													114	73
20	3.969	1.5×1	1470	3860	3860	49	114	78	15	63	15	6.6	11	6.5	30	16	M8×1P	48	
				1910	5240													134	73
20	6.35	3.5×1	2340	6610	6610	57	104	115	108	98	18	77	20	11	17.5	11	34	22	77
				2830	8200														104
20	6.35	3.5×1	3680	11120	11120	57	124	144	108	98	18	77	20	11	17.5	11	34	22	69
				4490	14050														144
20	6.35	3.5×1	4490	14050	14050	57	124	144	108	98	18	77	20	11	17.5	11	34	22	85

FSVE

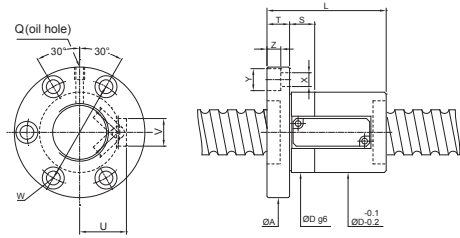

Unit:mm

SCREW SIZE		BALL DIA.	EFFECTIVE TURNS circuit x row	BASIC RATE LOAD (kgf)		NUT	FLANGE	FIT	BOLT	RETURN TUBE	OIL HOLE	STIFFNESS							
O.D.	LEAD			Dynamic (1×10 ⁶ REV.) Ca	Static Co								Dg6	L	A	T	W	S	X
36	10	6.35	3.5×1	3890	9390	84												76	
			5×1	4750	11860	60	84	100	18	80	20	11	17.5	11	36	22	M8×1P	93	
	12	6.35	3.5×1	3890	9390	85													58
			5×1	2990	6920	60	97	100	18	80	20	11	17.5	11	36	22	M8×1P	76	
	16	6.35	3.5×1	3890	9390	91													93
			5×1	2990	6920	60	107	100	18	80	20	11	17.5	11	36	22	M8×1P	76	
	20	6.35	1.5×1	2050	4450	91													93
			2.5×1	2990	6920	60	111	100	18	80	20	11	17.5	11	36	22	M8×1P	76	
			3.5×1	3890	9390	60	131	100	18	80	20	11	17.5	11	36	22	M8×1P	76	
			5×1	4750	11860	60	151	100	18	80	20	11	17.5	11	36	22	M8×1P	93	
	40	10	6.35	3.5×1	4130	10560	86												82
				5×1	5050	13340	64	96	104	18	84	20	11	17.5	11	38	22	PT1/8"	101
12		6.35	2.5×1	3180	7780	86													63
			3.5×1	4130	10560	64	98	104	18	84	20	11	17.5	11	38	22	PT1/8"	82	
16		6.35	5×1	5050	13340	110													101
			2.5×1	3180	7780	93													63
16		6.35	3.5×1	4130	10560	93													82
			5×1	5050	13340	125													101
16		7.144	2.5×1	3740	8790	92													65
			3.5×1	4870	11930	64	108	104	18	84	15	11	17.5	11	39	20	PT1/8"	84	
20		6.35	5×1	5950	15070	124													103
			1.5×1	2180	5000	84													43
20	6.35	2.5×1	3180	7780	104													63	
		3.5×1	4130	10560	64	124	104	18	84	20	11	17.5	11	38	22	PT1/8"	82		
40	6.35	5×1	5050	13340	144													101	
		1.5×1	2180	5000	64	130	104	18	84	20	11	17.5	11	38	20	PT1/8"	43		

FSVE

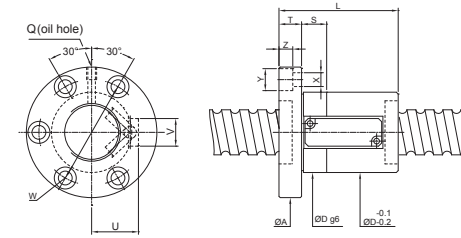

Unit:mm

SCREW SIZE		BALL DIA.	EFFECTIVE TURNS circuit x row	BASIC RATE LOAD (kgf)		NUT	FLANGE	FIT	BOLT	RETURN TUBE	OIL HOLE	STIFFNESS							
O.D.	LEAD			Dynamic (1×10 ⁶ REV.) Ca	Static Co								Dg6	L	A	T	W	S	X
50	10	6.35	3.5×1	4560	13230	85												97	
			5×1	5580	16710	73	95	118	18	96	20	11	17.5	11	43	22	PT1/8"	119	
	12	6.35	3.5×1	3510	9750	82													74
			5×1	2990	6920	60	109	100	18	80	20	11	17.5	11	36	22	M8×1P	76	
	12	7.144	2.5×1	4080	11260	93													75
			3.5×1	5300	15280	75	105	122	20	98	15	14	20	13	44	24	PT1/8"	99	
	16	6.35	5×1	6480	19300	117													121
			2.5×1	3510	9750	94													74
	16	6.35	3.5×1	4560	13230	73	110	118	18	96	20	11	17.5	11	43	22	PT1/8"	97	
			5×1	5580	16710	126													119
	16	7.144	2.5×1	4080	11260	100													75
			3.5×1	5300	15280	75	116	122	20	98	15	14	20	13	44	22	PT1/8"	99	
20	7.144	5×1	6480	19300	132													121	
		1.5×1	2790	7240	98													52	
20	7.144	2.5×1	4080	11260	118													75	
		3.5×1	5300	15280	75	138	122	20	98	15	14	20	13	44	20	PT1/8"	99		
20	7.938	5×1	6480	19300	158													121	
		2.5×1	4750	12090	119													78	
20	7.938	3.5×1	6180	16400	76	139	123	25	99	20	14	20	13	46	25	PT1/8"	101		
		5×1	7550	20720	159													124	
50	7.938	1.5×1	3250	7770	76	157	123	25	99	20	14	20	13	46	25	PT1/8"	53		

FSVE

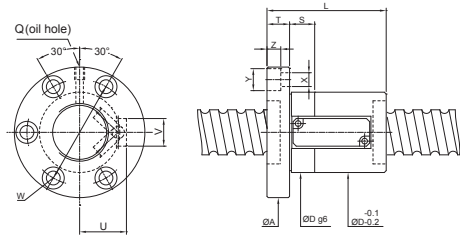

Unit:mm

SCREW SIZE		BALL DIA.	EFFECTIVE TURNS circuit x row	BASIC RATE LOAD (kgf)		NUT	FLANGE	FIT	BOLT	RETURN TUBE	OIL HOLE	STIFFNESS						
O.D.	LEAD			Dynamic (1x10 ⁶ REV.) Ca	Static Co								Dg6	L	A	T	W	S
63	10	6.35	3.5x1 5x1	5030	17020	86	86	133	22	108	20	14	20	13	49	24	PT1/8"	115
				6150	21500	86	96	133	22	108	20	14	20	13	49	24	PT1/8"	141
	12	6.35	3.5x1 5x1	3870	12540	84	84	133	22	108	20	14	20	13	49	24	PT1/8"	87
				5030	17020	86	96	133	22	108	20	14	20	13	49	24	PT1/8"	115
	12	7.144	3.5x1 5x1	4540	14460	90	90	133	22	108	20	14	20	13	49	24	PT1/8"	89
				5900	19620	87	102	134	22	110	20	14	20	13	50	25	PT1/8"	117
	16	7.144	3.5x1 5x1	4540	14460	97	97	133	22	110	20	14	20	13	50	25	PT1/8"	89
				5900	19620	87	113	134	22	110	20	14	20	13	50	25	PT1/8"	117
	16	7.938	3.5x1 5x1	5260	15430	112	112	128	28	118	25	18	26	17.5	52	25	PT1/8"	91
				6840	20940	89	128	148	28	118	25	18	26	17.5	52	25	PT1/8"	120
	20	6.35	3.5x1 5x1	3870	12540	104	104	124	22	108	20	14	20	13	49	24	PT1/8"	87
				5030	17020	86	124	133	22	108	20	14	20	13	49	24	PT1/8"	115
20	7.938	3.5x1 5x1	5260	15430	120	120	140	28	118	25	18	26	17.5	52	25	PT1/8"	91	
			6840	20940	89	140	148	28	118	25	18	26	17.5	52	25	PT1/8"	120	
20	9.525	3.5x1 5x1	8870	25870	120	120	152	28	122	25	18	26	17.5	54	28	PT1/8"	105	
			11530	35110	93	140	152	28	122	25	18	26	17.5	54	28	PT1/8"	136	
80	10	6.35	3.5x1 5x1	5630	21660	103	90	150	22	126	20	14	20	13	58	25	PT1/8"	133
				6880	27360	103	100	150	22	126	20	14	20	13	58	25	PT1/8"	164
	12	7.938	3.5x1 5x1	7670	27030	101	101	170	22	146	20	14	20	13	66	28	PT1/8"	143
				9380	34140	123	113	170	22	146	20	14	20	13	66	28	PT1/8"	177
	16	9.525	3.5x1 5x1	9900	33200	108	108	185	28	155	30	18	26	17.5	70	28	PT1/8"	124
				12990	45050	126	124	185	28	155	30	18	26	17.5	70	28	PT1/8"	162
20	9.525	3.5x1 5x1	9900	33200	120	120	185	28	155	30	18	26	17.5	70	28	PT1/8"	124	
			12990	45050	126	140	185	28	155	30	18	26	17.5	70	28	PT1/8"	162	
100	16	9.525	3.5x1 5x1	11320	41820	115	115	217	32	181	30	22	32	21.5	82	35	PT1/8"	139
				14720	56750	146	131	217	32	181	30	22	32	21.5	82	35	PT1/8"	182
	20	9.525	3.5x1 5x1	11320	41820	128	128	217	32	181	30	22	32	21.5	82	35	PT1/8"	139
				14720	56750	146	148	217	32	181	30	22	32	21.5	82	35	PT1/8"	182

FDVE

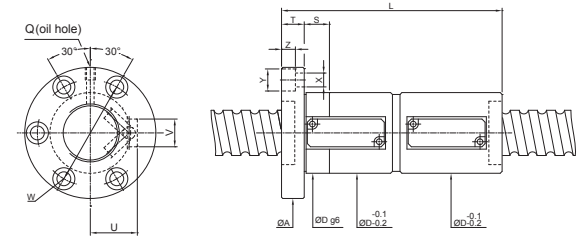

Unit:mm

SCREW SIZE		BALL DIA.	EFFECTIVE TURNS circuit x row	BASIC RATE LOAD (kgf)		NUT	FLANGE	FIT	BOLT	RETURN TUBE	OIL HOLE	STIFFNESS						
O.D.	LEAD			Dynamic (1x10 ⁶ REV.) Ca	Static Co								Dg6	L	A	T	W	S
12	10	2.381	2.5x1	420	720	25	102	48	10	36	10	4.5	8	4.4	14	12	M6x1P	30
				1210	2380	38	113	62	13	50	10	5.5	9.5	5.5	23	15	M6x1P	51
20	10	3.969	3.5x1	1580	3230	38	133	62	13	50	10	5.5	9.5	5.5	23	15	M6x1P	68
				830	1530	38	128	62	13	50	10	5.5	9.5	5.5	23	15	M6x1P	35
20	16	3.969	2.5x1	1210	2380	38	160	62	13	50	10	5.5	9.5	5.5	23	15	M6x1P	51
				830	1530	38	130	62	13	50	10	5.5	9.5	5.5	23	15	M6x1P	35
25	16	3.969	1.5x1	920	1930	42	126	68	15	55	15	6.6	11	6.5	26	14	M6x1P	41
				1340	3000	42	158	68	15	55	15	6.6	11	6.5	26	14	M6x1P	61
25	20	4.762	2.5x1	1170	2300	44	154	72	15	59	15	6.6	11	6.5	28	14	M6x1P	43
				1710	3580	44	194	72	15	59	15	6.6	11	6.5	28	14	M6x1P	63
32	20	4.762	3.5x1	2220	4860	44	234	72	15	59	15	6.6	11	6.5	28	14	M6x1P	83
				1010	2480	49	164	78	15	63	15	6.6	11	6.5	30	16	M8x1P	49
32	16	3.969	2.5x1	1470	3860	49	164	78	15	63	15	6.6	11	6.5	30	16	M8x1P	73
				1910	5240	49	196	78	15	63	15	6.6	11	6.5	30	16	M8x1P	96
32	16	6.35	3.5x1	2340	6610	49	228	78	15	63	15	6.6	11	6.5	30	16	M8x1P	120
				2830	6090	49	173	78	15	63	15	6.6	11	6.5	30	16	M8x1P	80
32	16	6.35	5x1	3680	8270	57	205	98	18	77	20	11	17.5	11	34	22	M8x1P	105
				4490	10450	57	237	98	18	77	20	11	17.5	11	34	22	M8x1P	131
32	20	3.969	1.5x1	1010	2480	49	134	78	15	63	15	6.6	11	6.5	30	16	M8x1P	49
				1470	3860	49	174	78	15	63	15	6.6	11	6.5	30	16	M8x1P	73
32	20	3.969	3.5x1	1910	5240	49	214	78	15	63	15	6.6	11	6.5	30	16	M8x1P	96
				2340	6610	49	254	78	15	63	15	6.6	11	6.5	30	16	M8x1P	120
32	20	6.35	2.5x1	2830	8200	57	204	98	18	77	20	11	17.5	11	34	22	M8x1P	80
				3680	11120	57	244	98	18	77	20	11	17.5	11	34	22	M8x1P	105
32	20	6.35	5x1	4490	14050	57	284	98	18	77	20	11	17.5	11	34	22	M8x1P	131

FDVE

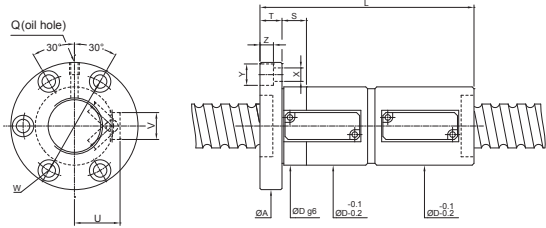

Unit:mm

SCREW SIZE		BALL DIA.	EFFECTIVE TURNS circuit × row	BASIC RATE LOAD (kgf)		NUT	FLANGE	FIT	BOLT	RETURN TUBE	OIL HOLE	STIFFNESS							
O.D.	LEAD			Dynamic (1×10 ⁶ REV.) Ca	Static Co								Dg6	L	A	T	W	S	X
36	10	6.35	3.5×1	3890	9390	60	155	100	18	80	20	11	17.5	11	36	22	M8×1P	115	
			5×1	4750	11860	175	175												143
	12	6.35	2.5×1	2990	6920	152													88
			3.5×1	3890	9390	60	176	100	18	80	20	11	17.5	11	36	22	M8×1P	115	
	16	6.35	5×1	4750	11860	200													143
			2.5×1	2990	6920	173													88
	20	6.35	3.5×1	3890	9390	60	205	100	18	80	20	11	17.5	11	36	22	M8×1P	115	
			5×1	4750	11860	237													143
1.5×1			2050	4450	164													59	
2.5×1			2990	6920	204														88
40	10	6.35	3.5×1	4130	10560	64	155	104	18	84	20	11	17.5	11	38	22	PT1/8"	125	
			5×1	5050	13340	175	175												155
	12	6.35	2.5×1	3180	7780	141													95
			3.5×1	4130	10560	64	165	104	18	84	20	11	17.5	11	38	22	PT1/8"	125	
	16	6.35	5×1	5050	13340	189													155
			2.5×1	3180	7780	173													95
	20	6.35	3.5×1	4130	10560	64	205	104	18	84	20	11	17.5	11	38	22	PT1/8"	125	
			5×1	5050	13340	237													155
2.5×1			3740	8790	173													98	
3.5×1			4870	11930	64	205	104	18	84	15	11	17.5	11	39	20	PT1/8"	128		
40	6.35	5×1	5950	15070	237													159	
		1.5×1	2180	5000	143													64	
		2.5×1	3180	7780	183													95	
		3.5×1	4130	10560	64	223	104	18	84	20	11	17.5	11	38	22	PT1/8"	125		
40	6.35	1.5×1	2180	5000	64	242	104	18	84	20	11	17.5	11	38	20	PT1/8"	64		

FDVE

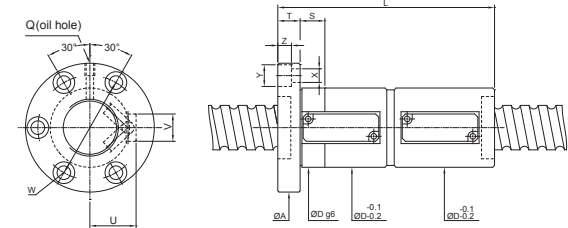

Unit:mm

SCREW SIZE		BALL DIA.	EFFECTIVE TURNS circuit × row	BASIC RATE LOAD (kgf)		NUT	FLANGE	FIT	BOLT	RETURN TUBE	OIL HOLE	STIFFNESS							
O.D.	LEAD			Dynamic (1×10 ⁶ REV.) Ca	Static Co								Dg6	L	A	T	W	S	X
50	10	6.35	3.5×1	4560	13230	73	155	118	18	96	20	11	17.5	11	43	22	PT1/8"	149	
			5×1	5580	16710	175	175												185
	12	6.35	2.5×1	3510	9750	152													112
			3.5×1	4560	13230	73	176	118	18	96	20	11	17.5	11	43	22	PT1/8"	149	
	16	6.35	5×1	5580	16710	200													185
			2.5×1	4080	11260	161													114
	20	6.35	3.5×1	5300	15280	75	185	122	20	98	15	14	20	13	44	24	PT1/8"	151	
			5×1	6480	19300	209													187
2.5×1			3510	9750	174													112	
3.5×1			4560	13230	73	206	118	18	96	20	11	17.5	11	43	22	PT1/8"	149		
40	6.35	5×1	5580	16710	238													185	
		2.5×1	4080	11260	173													114	
		3.5×1	5300	15280	75	205	122	20	98	15	14	20	13	44	22	PT1/8"	151		
		5×1	6480	19300	237													187	
50	7.144	1.5×1	2790	7240	172													77	
		2.5×1	4080	11260	204													114	
		3.5×1	5300	15280	75	244	122	20	98	15	14	20	13	44	20	PT1/8"	151		
		5×1	6480	19300	284													187	
20	7.938	2.5×1	4750	12090	219													117	
		3.5×1	6180	16400	76	259	123	25	99	20	14	20	13	46	25	PT1/8"	154		
40	7.938	5×1	7550	20720	299													191	
		1.5×1	3250	7770	76	305	123	25	99	20	14	20	13	46	25	PT1/8"	79		

FDVE

PMI Precision Ground BallScrew Low Noise Series

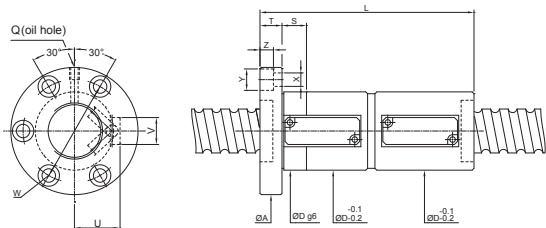

Unit:mm

SCREW SIZE		BALL DIA.	EFFECTIVE TURNS circuit × row	BASIC RATE LOAD (kgf)		NUT		FLANGE			FIT			BOLT			RETURN TUBE		OIL HOLE	STIFFNESS
O.D.	LEAD			Dynamic (1×10 ⁴ REV.) Ca	Static Co	Dg6	L	A	T	W	S	X	Y	Z	U	V	Q	kgf/μm		
63	10	6.35	3.5×1	5030	17020	86	155	133	22	108	20	14	20	13	49	24	PT1/8"	178		
			5×1	6150	21500														175	220
	12	6.35	3.5×1	5030	17020	86	177	133	22	108	20	14	20	13	49	24	PT1/8"	178		
			5×1	6150	21500														201	220
	12	7.144	2.5×1	4540	14460	87	182	134	22	110	20	14	20	13	50	25	PT1/8"	180		
			5×1	5900	19620														206	224
	16	7.144	2.5×1	4540	14460	87	209	134	22	110	20	14	20	13	50	25	PT1/8"	184		
			5×1	5900	19620														241	228
	16	7.938	2.5×1	5260	15430	89	239	148	28	118	25	18	26	17.5	52	25	PT1/8"	178		
			5×1	6840	20940														271	220
	20	6.35	2.5×1	3870	12540	86	245	133	22	108	20	14	20	13	49	24	PT1/8"	178		
			5×1	5030	17020														285	220
20	7.938	2.5×1	5260	15430	89	261	148	28	118	25	18	26	17.5	52	25	PT1/8"	184			
		5×1	6840	20940														301	228	
20	9.525	2.5×1	8870	25870	93	259	152	28	122	25	18	26	17.5	54	28	PT1/8"	208			
		5×1	11530	35110														299	258	
80	10	6.35	3.5×1	5630	21660	103	159	150	22	126	20	14	20	13	58	25	PT1/8"	207		
			5×1	6880	27360														179	256
	12	7.938	3.5×1	7670	27030	123	184	170	22	146	20	14	20	13	66	28	PT1/8"	222		
			5×1	9380	34140														208	275
	16	9.525	2.5×1	9900	33200	126	220	185	28	155	30	18	26	17.5	70	28	PT1/8"	189		
			5×1	12990	45050														252	311
20	9.525	2.5×1	9900	33200	126	260	185	28	155	30	18	26	17.5	70	28	PT1/8"	189			
		5×1	12990	45050														300	311	
100	16	9.525	2.5×1	11320	41820	146	243	217	32	181	30	22	32	21.5	82	35	PT1/8"	213		
			5×1	14720	56750														275	283
	20	9.525	2.5×1	11320	41820	146	268	217	32	181	30	22	32	21.5	82	35	PT1/8"	213		
			5×1	14720	56750														308	283

Features

Lower Noise

TYPE-S SERIES: Optimum design of recirculation path can absorb noise from impact of balls to reduce noise level 5~10 dB, comparing with general series.

Quality Tone

The materials of recirculation structure made from composite materials will keep low audio frequency and supple.

Low Vibration and Smooth Operation

The recirculation path adapts tangency design that reduces impact force form balls, for the reason that the vibration of nut is smoothly.

Applications

CNC Machinery / General Machines / Semi-conductor Equipments



S series

FSWS

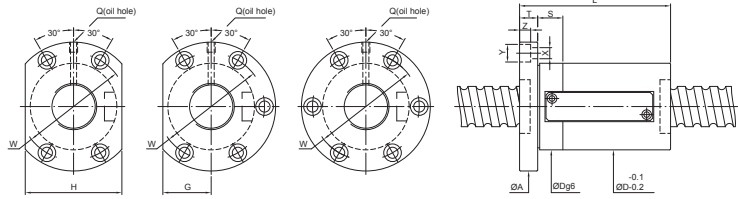

Unit:mm

SCREW SIZE	BALL DIA.	EFFECTIVE TURNS circuit × row	BASIC RATE LOAD (kgf)		NUT	FLANGE				FIT	BOLT				RETURN TUBE	OIL HOLE	STIFFNESS		
			Dynamic (1×10 ⁶ REV.) Ca	Static Co		Dg6	L	A	T		W	G	H	S				X	Y
32	8	4.762	5×1	3900	10930	66	82	102	15	84	37	74	15	9	14	8.5	M8×1P	80	
	12	6.35	5×1 3.5×1	5690 4620	14770 11400	74	104 108	108	18	88	41	82	15	11	17.5	11	M8×1P	85 69	
	16	6.35	5×1	5650	14390	74	124	108	18	88	41	82	15	11	17.5	11	M8×1P	85	
	20	6.35	5×1	5600	14300	748	144	108	18	88	41	82	15	11	17.5	11	M8×1P	58	
36	10	6.35	5×1	6080	16460	78	95	121	18	99	45	90	15	11	17.5	11	M8×1P	93	
	8	4.762	5×1	4410	14230	74	82	118	18	96	49	98	15	11	17.5	11	PT1/8"	94	
	10	6.35	5×1	6410	18420	86	96	128	18	106	49	98	15	11	17.5	11	PT1/8"	101	
	12	6.35	5×1	6400	18390	86	110	128	18	106	49	98	15	11	17.5	11	PT1/8"	101	
40	12	7.144	5×1	7520	20800	86	104	128	18	106	49	98	15	11	17.5	11	PT1/8"	103	
	16	7.144	1.5×1	3220	7770	76													45
			2.5×1	4710	12090	86	92	128	18	106	49	98	15	11	17.5	11	PT1/8"	65	
			3.5×1	6130	16410	108													84
	20	6.35	3.5×1	5190	14450	86	124	128	18	106	49	98	15	11	17.5	11	PT1/8"	82	
			5×1	6340	18260	144													101
45	10	7.144	3.5×1	6490	18460	90	86	133	18	111	49	98	20	11	17.5	11	PT1/8"	91	
	12	7.144	5×1	7920	23300	90	104	136	18	114	49	98	20	11	17.5	11	PT1/8"	113	
	16	7.144	2.5×1	4970	13560	91	136	114											70
3.5×1			6460	18400	90	108	134	18	112	49	98	20	11	17.5	11	PT1/8"	91		
50	8	4.762	5×1	4780	17550	84	84	81	127	18	105	45	90	20	11	17.5	PT1/8"	109	
	12	7.938	5×1	9590	28790	100	105	146	18	122	58	116	20	14	20	13	PT1/8"	124	
80	12	7.937	5×1	11890	47170	136	136	113	182	22	158	68	136	20	14	20	PT1/8"	177	

FDWS

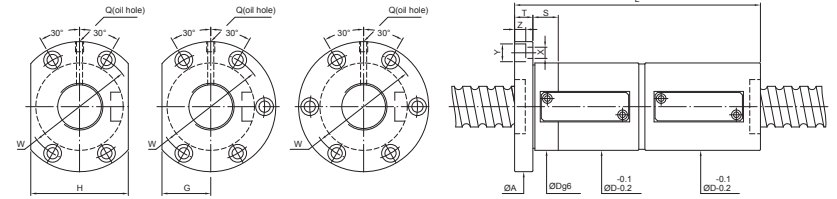

Unit:mm

SCREW SIZE	BALL DIA.	EFFECTIVE TURNS circuit × row	BASIC RATE LOAD (kgf)		NUT	FLANGE				FIT	BOLT				RETURN TUBE	OIL HOLE	STIFFNESS		
			Dynamic (1×10 ⁶ REV.) Ca	Static Co		Dg6	L	A	T		W	G	H	S				×	Y
32	8	4.762	5×1	3900	10930	66	146	102	15	84	37	74	15	9	14	8.5	M8×1P	124	
	12	6.35	5×1	5690	14470	74	197	108	18	88	41	82	15	11	17.5	11	M8×1P	131	
	16	6.35	3.5×1 5×1	4620 5650	11400 14390	74	205 237	108	18	88	41	82	15	11	17.5	11	M8×1P	105 131	
	20	6.35	5×1	5600	14300	74	284	108	18	88	41	82	15	11	17.5	11	M8×1P	131	
36	10	6.35	5×1	6080	16460	78	175	121	18	99	45	90	15	11	17.5	11	M8×1P	142	
	8	4.762	5×1	4410	14230	74	146	118	18	96	49	98	15	11	17.5	11	PT1/8"	147	
	10	6.35	5×1	6410	18420	86	175	128	18	106	49	98	15	11	17.5	11	PT1/8"	155	
	12	6.35	5×1	6400	18390	86	189	128	18	106	49	98	15	11	17.5	11	PT1/8"	155	
40	12	7.144	5×1	7520	20800	86	197	128	18	106	49	98	15	11	17.5	11	PT1/8"	158	
	16	7.144	1.5×1	3220	7770	141													65
			2.5×1	4710	12090	86	173	128	18	106	49	98	15	11	17.5	11	PT1/8"	98	
			3.5×1	6130	16410	205													128
	20	6.35	3.5×1	5190	14450	86	223	128	18	106	49	98	15	11	17.5	11	PT1/8"	125	
			5×1	6340	18260	263													155
45	10	7.144	3.5×1	6490	18460	90	156	133	18	111	49	98	20	11	17.5	11	PT1/8"	139	
	12	7.144	5×1	7920	23300	90	188	136	18	114	49	98	20	11	17.5	11	PT1/8"	173	
	16	7.144	2.5×1	4970	13560	164	136	114											106
3.5×1			6460	18400	90	196	134	18	112	49	98	20	11	17.5	11	PT1/8"	139		
50	8	4.762	5×1	4780	17550	84	145	127	18	105	45	90	20	11	17.5	11	PT1/8"	169	
	12	7.938	5×1	9590	28790	100	219	146	18	122	58	116	20	14	20	13	PT1/8"	191	
80	12	7.938	5×1	11890	47170	136	208	182	22	158	68	136	20	14	20	13	PT1/8"	275	

FSVS

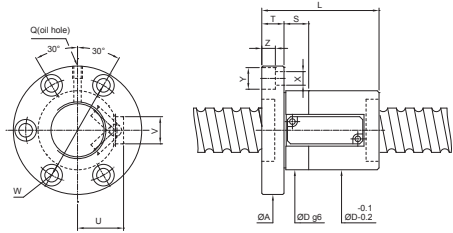

Unit:mm

SCREW SIZE		BALL DIA.	EFFECTIVE TURNS circuit × row	BASIC RATE LOAD (kgf)		NUT		FLANGE			FIT		BOLT			RETURN TUBE	OIL HOLE	STIFFNESS kgf/4m
O.D.	LEAD			Dynamic (1×10 ⁵ REV.) Ca	Static Co	Dg6	L	A	T	W	S	×	Y	Z	U	V	Q	
32	8	4.762	5×1	3900	10930	53	82	87	15	69	15	9	14	8.5	31	16	M8×1P	80
	12	6.35	5×1	5690	14470	57	104	98	18	77	20	11	17.5	11	34	22	M8×1P	85
	16	6.35	3.5×1 5×1	4620 5650	11400 14390	57	108 124	98	18	77	20	11	17.5	11	34	22	M8×1P	69 85
	20	6.35	5×1	5600	14300	57	144	98	18	77	20	11	17.5	11	34	22	M8×1P	85
36	10	6.35	5×1	6080	16460	61	95	103	18	81	20	11	17.5	11	36	22	M8×1P	93
	8	4.762	5×1	4410	14230	62	82	104	18	82	20	11	17.5	11	36	22	PT1/8"	94
40	10	6.35	5×1	6410	18420	64	96	104	18	84	20	11	17.5	11	38	22	PT1/8"	101
	12	6.35	5×1	6400	18390	64	110	104	18	84	20	11	17.5	11	38	22	PT1/8"	101
	12	7.144	5×1	7520	20800	64	104	104	18	84	15	11	17.5	11	39	20	PT1/8"	103
	16	7.144	1.5×1 2.5×1	3220 4710	7770 12090	64	76 92	104	18	84	15	11	17.5	11	39	20	PT1/8"	45 65
	16	7.144	3.5×1	6130	16410	64	108	104	18	84	15	11	17.5	11	39	20	PT1/8"	84
	20	6.35	3.5×1 5×1	5190 6340	14450 18260	69	124 144	104	18	84	20	11	17.5	11	38	22	PT1/8"	82 101
	20	7.144	5×1	7900	23240	69	125	104	18	84	20	11	17.5	11	38	22	PT1/8"	101
45	10	7.144	3.5×1	6490	18460	73	86	115	18	93	20	11	17.5	11	45	22	PT1/8"	91
	12	7.144	5×1	7920	23300	76	104	118	18	96	20	11	17.5	11	45	22	PT1/8"	113
	16	7.144	2.5×1 3.5×1 5×1	4970 6460 7900	13560 18400 23240	75	91 108 125	117	18	95	20	11	17.5	11	45	22	PT1/8"	70 91 113
50	8	4.762	5×1	4780	17550	71	81	113	18	91	20	11	17.5	11	40	22	PT1/8"	109
	12	7.938	5×1	9590	28790	81	105	127	18	103	20	14	20	13	46	25	PT1/8"	124
80	12	7.938	5×1	11890	47170	123	113	170	22	146	20	14	20	13	66	28	PT1/8"	177

FDVS

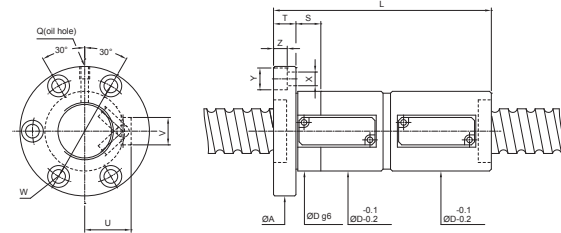

Unit:mm

SCREW SIZE		BALL DIA.	EFFECTIVE TURNS circuit × row	BASIC RATE LOAD (kgf)		NUT		FLANGE			FIT		BOLT			RETURN TUBE	OIL HOLE	STIFFNESS kgf/4m
O.D.	LEAD			Dynamic (1×10 ⁵ REV.) Ca	Static Co	Dg6	L	A	T	W	S	×	Y	Z	U	V	Q	
32	8	4.762	5×1	3900	10930	53	146	87	15	69	15	9	14	8.5	31	16	M8×1P	124
	12	6.35	5×1	5690	14470	57	197	98	18	77	20	11	17.5	11	34	22	M8×1P	131
	16	6.35	3.5×1 5×1	4620 5650	11400 14390	57	205 237	98	18	77	20	11	17.5	11	34	22	M8×1P	105 131
	20	6.35	5×1	5600	14300	57	284	98	18	77	20	11	17.5	11	34	22	M8×1P	131
36	10	6.35	5×1	6080	16460	61	175	103	18	81	20	11	17.5	11	36	22	M8×1P	142
	8	4.762	5×1	4410	14230	62	146	104	18	82	20	11	17.5	11	36	22	PT1/8"	147
40	10	6.35	5×1	6410	18420	64	175	104	18	84	20	11	17.5	11	38	22	PT1/8"	155
	12	6.35	5×1	6400	18390	64	189	104	18	84	20	11	17.5	11	38	22	PT1/8"	155
	12	7.144	5×1	7520	20800	64	197	104	18	84	15	11	17.5	11	39	20	PT1/8"	158
	16	7.144	1.5×1 2.5×1 3.5×1	3220 4710 6130	7770 12090 16410	64	141 173 205	104	18	84	15	11	17.5	11	39	20	PT1/8"	65 98 128
	20	6.35	3.5×1 5×1	5190 6340	14450 18260	69	223 263	104	18	84	20	11	17.5	11	38	22	PT1/8"	125 155
	10	7.144	3.5×1	6490	18460	73	156	115	18	93	20	11	17.5	11	45	22	PT1/8"	139
	12	7.144	5×1	7920	23300	76	188	118	18	96	20	11	17.5	11	45	22	PT1/8"	173
45	16	7.144	2.5×1 3.5×1 5×1	4970 6460 7900	13560 18400 23240	75	164 196 228	117	18	95	20	11	17.5	11	45	22	PT1/8"	106 139 173
	8	4.762	5×1	4780	17550	71	145	113	18	91	20	11	17.5	11	40	22	PT1/8"	169
	12	7.938	5×1	9590	28790	81	219	127	18	103	20	14	20	13	46	25	PT1/8"	191
80	12	7.938	5×1	11890	47170	123	208	170	22	146	20	14	20	13	66	28	PT1/8"	275

End Cap Series

FSKC

Features

The back system is designed by the front and rear ends of cycle paths, with the nut on the through-hole as the ball back, so that all nuts are covered with bead groove ball so effectively in the same length under the nut, end plugs nuts than the outer cycle nut with higher dynamic loads.

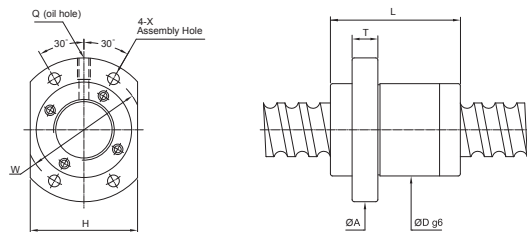

Unit: mm

SCREW SIZE		BALL DIA	EFFECTIVE TURNS circuit X number of thread	BASIC RATE LOAD (kgf)		BALLNUT DIMENSION									
O.D.	LEAD			Dynamic (1×10 ⁶ REV.) Ca	Static Co	NUT		FLANGE				BOLT	OIL HOLE	STIFFNESS	
						Dg6	L	A	T	H	W	X	Q		kgf/μm
15	10	3.175	2.8×2	1410	2800	34	44	57	10	40	45	5.5	M6×1P	34	
16	16	3.175	1.8×2	700	1400	32	38	53	10	38	42	4.5	M6×1P	18	
20	20	3.175	1.8×2	1100	2500	39	52	62	10	46	50	5.5	M6×1P	29	
25	25	3.969	1.8×2	1650	3900	47	62	74	12	56	60	6.6	M6×1P	35	
			1.8×4	2830	7800										69
32	32	4.762	1.8×2	2360	5940	58	78	92	15	68	74	9	M6×1P	44	
			1.8×4	4280	11800										87
36	24	7.144	2.8×2	6450	15220	75	94	115	18	86	94	11	M6×1P	77	
40	40	6.35	1.8×2	3860	9900	73	95	114	17	84	93	11	M6×1P	55	
			1.8×4	7000	19880										108
50	50	7.938	1.8×2	5800	15800	90	122	135	20	104	112	14	M6×1P	68	
			1.8×4	10520	31600										135

Ultra Lead-End Cap Series

FSKC

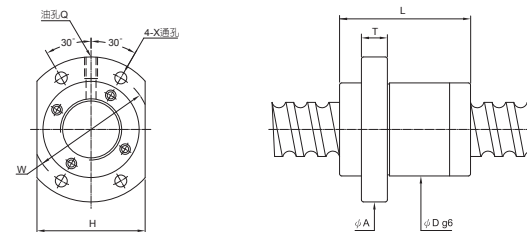

Unit: mm

SCREW SIZE		BALL DIA	EFFECTIVE TURNS circuit X number of thread	BASIC RATE LOAD (kgf)		BALLNUT DIMENSION									
O.D.	LEAD			Dynamic (1×10 ⁶ REV.) Ca	Static Co	NUT		FLANGE				BOLT	OIL HOLE	STIFFNESS	
						Dg6	L	A	T	H	W	X	Q		kgf/μm
15	30	3.715	0.8×2	480	800	32	34	53	10	33	43	5.5	M6×1P	12	
			1.8×1	530	900		64								13
20	40	3.175	0.8×2	550	1110	38	41	58	10	40	48	5.5	M6×1P	14	
			1.8×1	610	1250		81								16
25	50	3.969	0.8×2	820	1730	46	50	70	12	48	58	6.6	M6×1P	17	
			1.8×1	910	1950		100								19

Ballscrews For Heavy Load

Features

Focused on improvements of contact points of balls and thread grooves, ball diameter and circulation system for new type, FSVH. The rated dynamic load has been increased to as two times as that of conventional type, FSVC.

Long Life

Structure of the newly developed circulation system is designed to distribute the load uniformly to the load balls and it also increases the life of ballscrews. On conventional circulation system, FSVC, the returning tube is inserted into the holes on ballnut perpendicularly which forms an advancing angle. While ball moves into returning tube, it will hit tube end area and then move into returning tube. New circulation system, FSVH, ball will move into returning tube smoothly by tangent line as the same direction as lead angle. It can increase the life of circulation system structure.

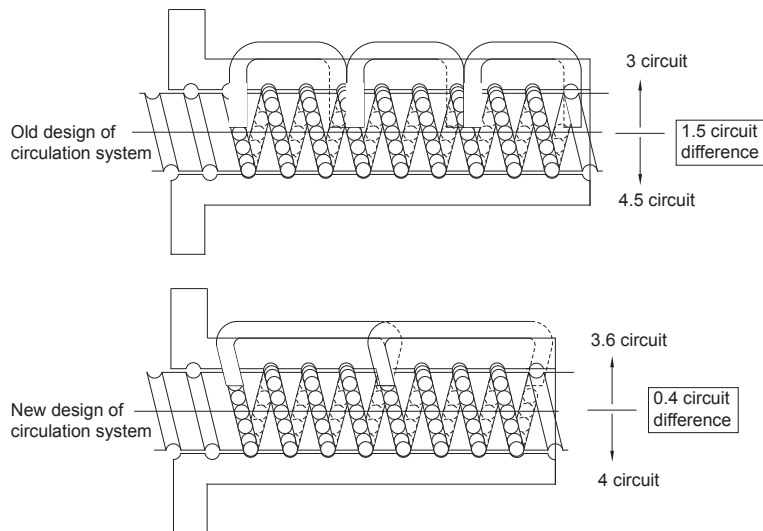

Fig.4 Circuit difference for heavy load ballscrew

High DN Value

With the newly developed circulation system, ballscrews can meet the demands of high speed running with high DN value.

Low Noise

To use tangential circulation system structure, it can eliminate the noise while balls run into the returning tube.

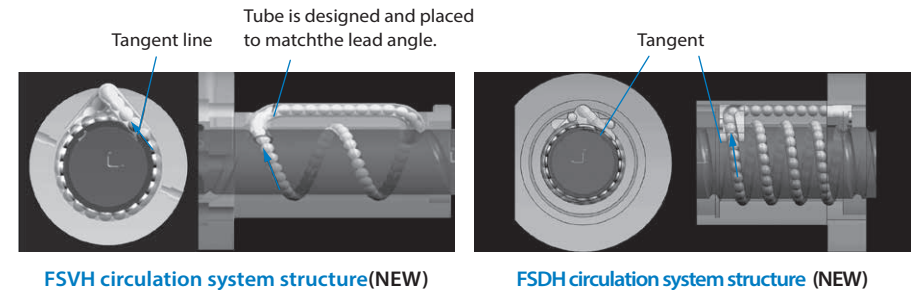
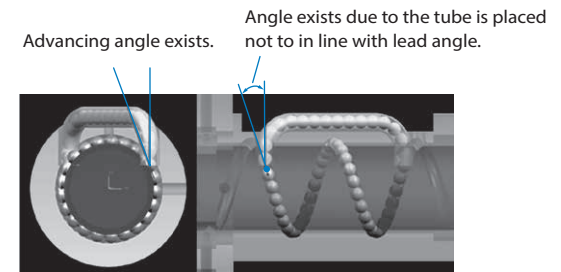

Fig.5 Circulation system structure for FSVH and FSDH



FSVC circulation system structure

Fig.6 Circulation system structure for FSVC

Various Specifications Combination

PMI can supply various ballscrews with diameter 40~120mm and lead 10mm to 60mm (Please contact PMI for your specific design requirement)

Recommend mounting direction of heavy load ball screws

In order to support equal load distribution for shaft and nut, recommend mounting direction of ball screws allow fig.7[A1-182] This mounting direction can avoid vibration as axial load uneven distribution for ball screws, therefore increase service life efficient.

FSVH

Accuracy Grade and Axial Play

If you have any question about accuracy grade and axial play(e.g. axial play <0), please contact our sales for your specific design requirement.

Unit:mm

Grade	Axial play	S	N
	C6	0.010 or less	C6S

Application

Plastic Injection Machines / Press and Forging Machines / Semi-conductor Equipments / General Machines

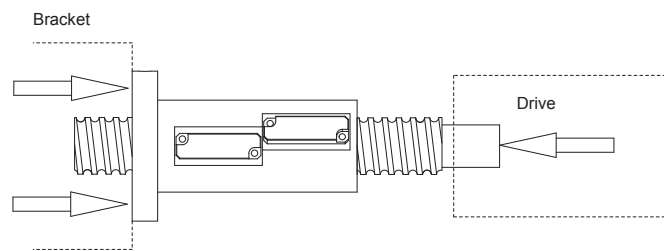

Fig.7 Recommend mounting direction of heavy load ballscrew

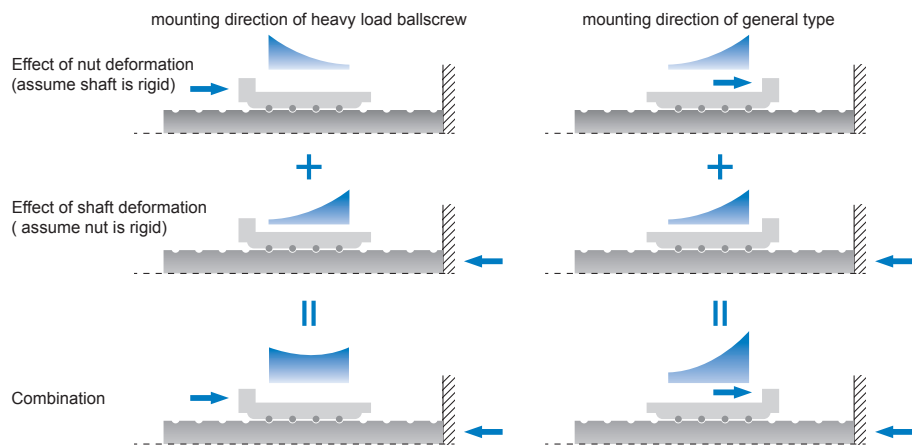
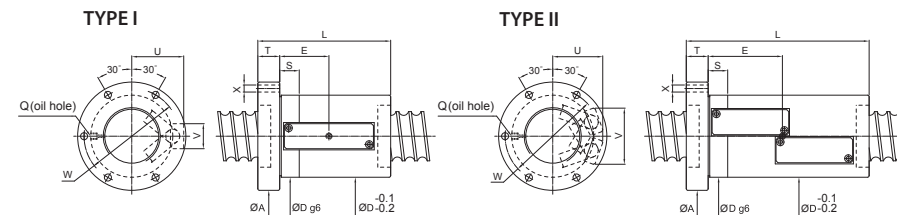

Fig.8 Load distribution



Unit:mm

SCREW SIZE	O.D.	LEAD	BALL DIA.	EFFECTIVE TURNS circuit × row	BASIC RATE LOAD (kgf)		NUT		FLANGE			FIT	OIL HOLE		BOLT RETURN TUB			Type
					Dynamic (1×10 ⁶ REV.) Ca	Static Co	Dg6	L	A	T	W		S	Q	E	X	V	
40	10	7.938	3.5×2	15000	41800	66	124	98	18	83	20	M6x1P	50.75	9	51	43	II	
	12	9.525	3.5×2	18600	48200	70	156	103	18	86	20	M6x1P	58	9	55	45	II	
45	10	7.938	3.5×2	15900	47300	70	134	104	18	87	20	M6x1P	54.2	9	54	45	II	
	10	7.938	3.5×2	16700	52900	77	133	109	18	92	20	M6x1P	53.7	9	60	48	II	
50	12.7	6×1	24800	63700	95	168	128	28	112	20	PT1/8"	70.5	9	32	60	I		
	12.7	3.5×2	31200	83500		200	128	28	112	20		86	9	72	62	II		
	20	12.7	3.5×2	31200		84800	95	235	128	28		112	20	PT1/8"	97	9	72	62
55	10	7.938	3.5×2	17500	58500	80	153	114	28	97	20	PT1/8"	62.1	9	61	49	II	
	16	12.7	6×1	25800	71800	100	168	133	28	115	20	PT1/8"	69.5	9	32	63	I	
			32600	94000	100	200	133	28	115	20	84.5		9	77	64	II		
63	16	12.7	6×1	27800	81700	105	168	138	28	122	25	PT1/8"	65.25	9	32	66	I	
			3.5×2	35000	107000	105	202	138	28	122	25		82.25	9	80	67	II	
	6×2	50300	164000	105	266	138	28	122	25	114.25	9		80	67	II			
80	20	15.875	2.5×2	35900	99300	117	210	157	32	137	25	PT1/8"	96	11	88	74	II	
			3.5×2	46600	134700	117	246	157	32	137	25		105.5	11	88	74	II	
			6×2	35900	99300	117	235	157	32	137	25		PT1/8"	91	11	88	75	II
80	16	12.7	6×1	30900	104400	120	172	158	32	139	25	PT1/8"	66	9	36	73	I	
			3.5×2	39000	136700	120	205	158	32	139	25		84	9	89	74	II	
	6×2	56000	208700	120	275	158	32	139	25	122	9		89	74	II			
	2.5×2	40100	127000	130	210	168	32	150	25	87.5	11		90	83	II			
20	15.875	3.5×2	52100	172400	130	250	168	32	150	25	PT1/8"	107.5	11	90	83	II		
			75000	263200	130	330	168	32	150	30	147.5	11	90	83	II			
25	19.05	3.5×2	67700	206100	145	305	188	40	165	25	PT1/8"	119	11	108	94	II		
			97200	314600	145	402	188	40	165	30		169	11	108	94	II		

FSVH

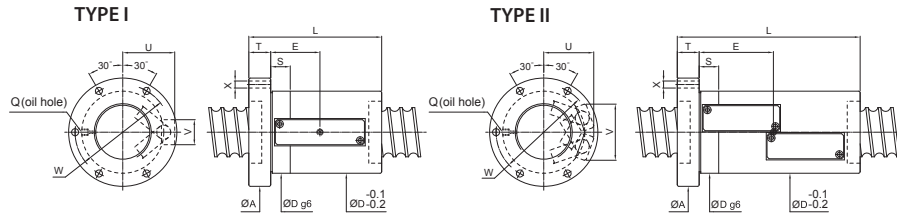

Unit:mm

SCREW SIZE	BALL DIA.	EFFECTIVE TURNS circuit × row	BASIC RATE LOAD (kgf)		NUT		FLANGE				FIT	OIL HOLE		BOLT		RETURN TUB	Type
			Dynamic (1×10 ⁶ REV.) Ca	Static Co	Dg6	L	A	T	W	S		Q	E	X	V		
100	16	12.7	6×1	34200	133200	145	172	185	32	165	25	PT1/8"	63.5	11	38	85	I
			3.5×2	43200	174500	145	205	185	32	165	25		79.5	11	98	85	II
			6×2	62000	266300	145	275	185	32	165	25		117.5	11	98	85	II
	20	15.875	2.5×2	44800	160900	150	205	194	32	172	30	PT1/8"	82	11	107	92	II
			3.5×2	58300	218400	150	245	194	32	172	30		102	11	107	92	II
			6×2	83800	333300	150	330	194	32	172	30		147	11	107	92	II
25	19.05	3.5×2	74900	260200	165	305	218	40	190	30	PT1/8"	122	11	111	102	II	
		6×2	107700	397100	165	410	218	40	190	30		177	11	111	102	II	
120	16	12.7	6×1	36840	157360	173	205	213	40	193	30	PT1/8"	84	11	38	93	I
			3.5×2	46480	206200	173	230	213	40	193	30		101	11	108	94	II
	20	15.875	6×1	46000	160800	173	222	213	40	193	30	PT1/8"	95	11	54	100	I
			3.5×2	58100	210700	173	260	213	40	193	30		116	11	121	104	II
	25	19.05	6×1	59200	194500	173	261	213	40	193	30	PT1/8"	109.5	11	50	106	I
			3.5×2	82100	314300	173	314	213	40	193	30		135.5	11	129	109	II

PMI Precision Ground BallScrew

Heavy Load Series of End Deflector FSDH

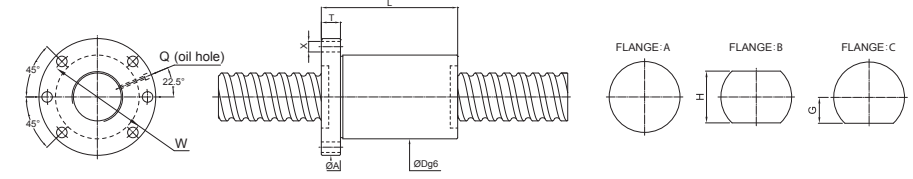

Unit:mm

SCREW SIZE	BALL DIA.	EFFECTIVE TURNS circuit × number of thread	BASIC RATE LOAD (kgf)		NUT		FLANGE				OIL HOLE	BOLT		
			Dynamic (1×10 ⁶ REV.) Ca	Static Co	Dg6	L	A	T	W	G			H	Q
45	12	9.525	5×1	13600	35400	84	98	128	24	106	57	114	PT1/8"	14
	16	9.525	5×1	13500	35300	84	122	128	24	106	57	114	PT1/8"	14
	20	9.525	4×1	11000	27900	84	122	128	24	106	57	114	PT1/8"	14
50	16	12.7	5×1	21100	53700	102	125	146	28	124	65	130	PT1/8"	14
	20	12.7	4×1	17200	42400	102	124	146	28	124	65	130	PT1/8"	14
	40	12.7	3×2	23400	61200	102	157	146	28	124	65	130	PT1/8"	14
63	32	15.875	4×1	25500	66000	126	176	182	32	154	81	162	PT1/8"	18
	40	15.875	3×2	35300	96600	126	169	182	32	154	81	162	PT1/8"	18
80	50	19.05	4×2	66600	204000	155	255	224	40	190	100	200	PT1/8"	22
100	60	19.05	4×2	73400	251500	175	295	244	40	210	100	200	PT1/8"	22

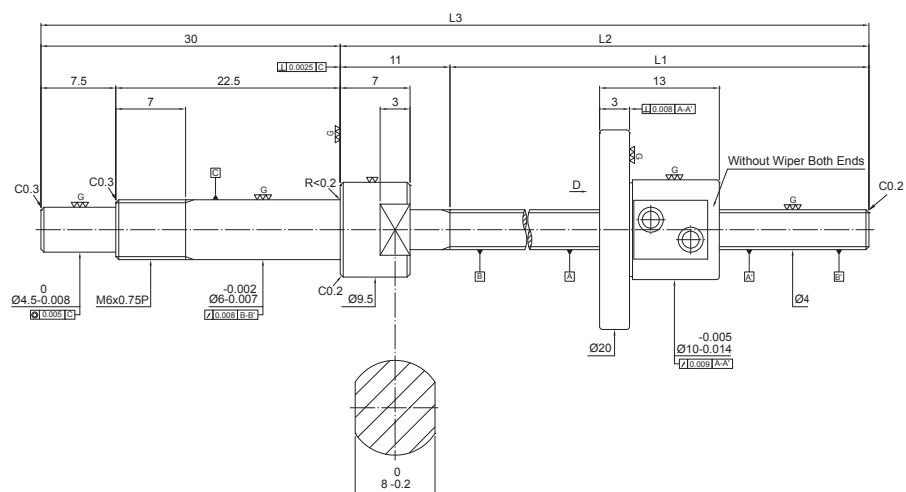

Specification of ball screw

Production Specification	With Preload	Without Preload
Number of Thread / Thread Direction	1/Right	
BCD	4.1	
Lead	1	
Ball Dia.	0.8	
Effective Turns (Circuit \times Row)	2.5 \times 1	
Lead Angle	4.44	
Dynamic Rate Load Ca (kgf)	49	
Static Rate Load Co (kgf)	70	
Axial Play	0	0.005 or less
Preloading Torque (kgf-cm)	0.01~0.1	0.03 or less

Unit: mm

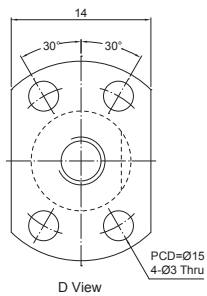

D View

Model No.	Screw Spindle (Shaft) Length			Accuracy Grade	Lead Accuracy		
	L1	L2	L3		Specified Travel (T)	Accumulated reference lead deviation E	Lead Deriation in random 300mm e_{300}
FSM0401-C3-1R-0085	44	55	85	3	0	0.012	0.008
FSM0401-C3-1R-0105	64	75	105	3	0	0.012	0.008
FSM0401-C3-1R-0135	94	105	135	3	0	0.012	0.008

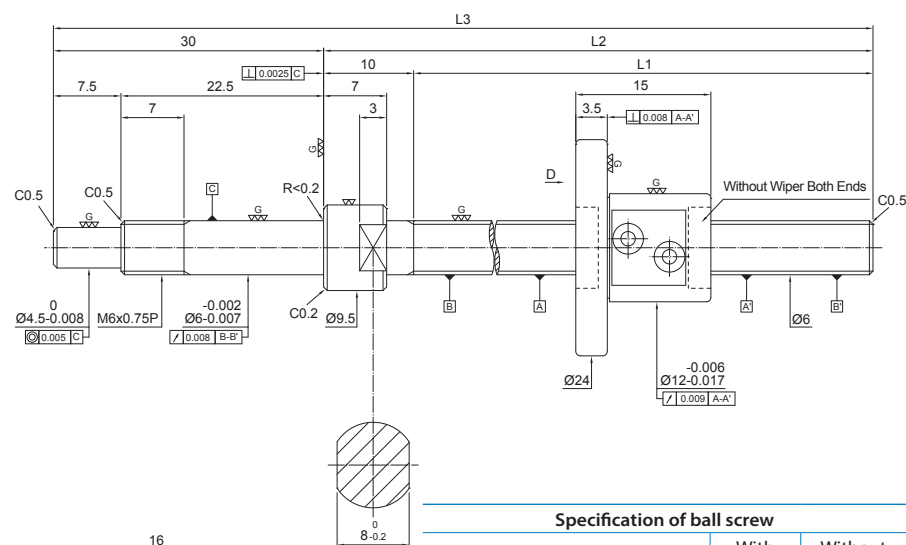

Specification of ball screw

Production Specification	With Preload	Without Preload
Number of Thread / Thread Direction	1/Right	
BCD	6.1	
Lead	1	
Ball Dia.	0.8	
Effective Turns (Circuit \times Row)	2.5 \times 1	
Lead Angle	2.99	
Dynamic Rate Load Ca (kgf)	58	
Static Rate Load Co (kgf)	100	
Axial Play	0	0.005 or less
Preloading Torque (kgf-cm)	0.01~0.15	0.03 or less

Unit: mm

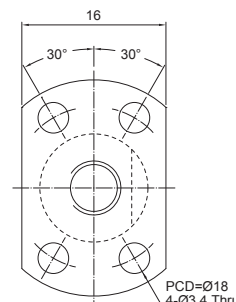

D View

Model No.	Screw Spindle (Shaft) Length			Accuracy Grade	Lead Accuracy		
	L1	L2	L3		Specified Travel (T)	Accumulated reference lead deviation E	Lead Deriation in random 300mm e_{300}
FSM0601-C3-1R-0105	65	75	105	3	0	0.012	0.008
FSM0601-C3-1R-0135	95	105	135	3	0	0.012	0.008
FSM0601-C3-1R-0165	125	135	165	3	0	0.012	0.008

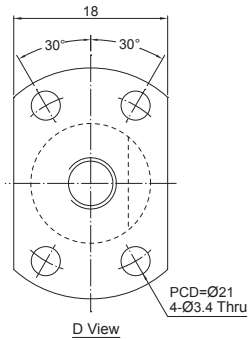
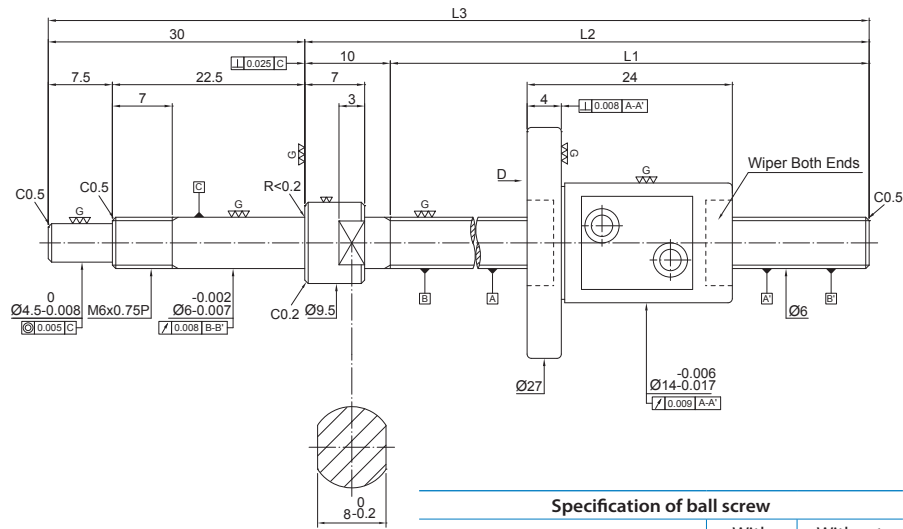
Specification of ball screw

Production Specification	With Preload	Without Preload
Number of Thread / Thread Direction	1/Right	
BCD	6.3	
Lead	2	
Ball Dia.	1.588	
Effective Turns (Circuit × Row)	2.5 × 1	
Lead Angle	5.77	
Dynamic Rate Load Ca (kgf)	160	
Static Rate Load Co (kgf)	210	
Axial Play	0	0.005 or less
Preloading Torque (kgf-cm)	0.01~0.2	0.05 or less

Unit: mm

Model No.	Screw Spindle (Shaft) Length			Accuracy Grade	Lead Accuracy		
	L1	L2	L3		Specified Travel (T)	Accumulated reference lead deviation E	Lead Derivation in random 300mm ϵ_{300}
FSM0602-C3-1R-0105	65	75	105	3	0	0.012	0.008
FSM0602-C3-1R-0135	95	105	135	3	0	0.012	0.008
FSM0602-C3-1R-0165	125	135	165	3	0	0.012	0.008

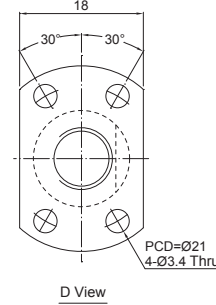
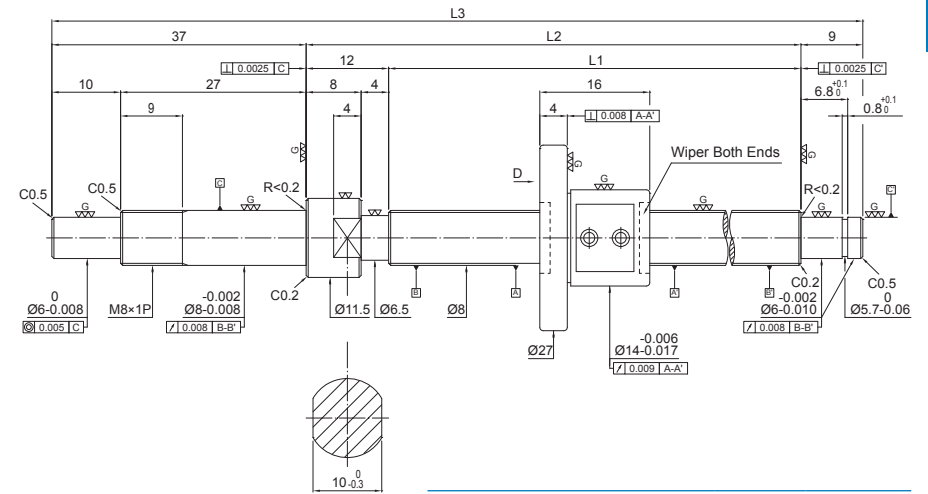
Specification of ball screw

Production Specification	With Preload	Without Preload
Number of Thread / Thread Direction	1/Right	
BCD	8.1	
Lead	1	
Ball Dia.	0.8	
Effective Turns (Circuit × Row)	2.5 × 1	
Lead Angle	2.25	
Dynamic Rate Load Ca (kgf)	66	
Static Rate Load Co (kgf)	140	
Axial Play	0	0.005 or less
Preloading Torque (kgf-cm)	0.01~0.2	0.05 or less

Unit: mm

Model No.	Screw Spindle (Shaft) Length			Accuracy Grade	Lead Accuracy		
	L1	L2	L3		Specified Travel (T)	Accumulated reference lead deviation E	Lead Derivation in random 300mm ϵ_{300}
FSM0801-C3-1R-0138	80	92	138	3	0	0.012	0.008
FSM0801-C3-1R-0168	110	122	168	3	0	0.012	0.008
FSM0801-C3-1R-0198	140	152	198	3	0	0.012	0.008
FSM0801-C3-1R-0248	190	202	248	3	0	0.012	0.008

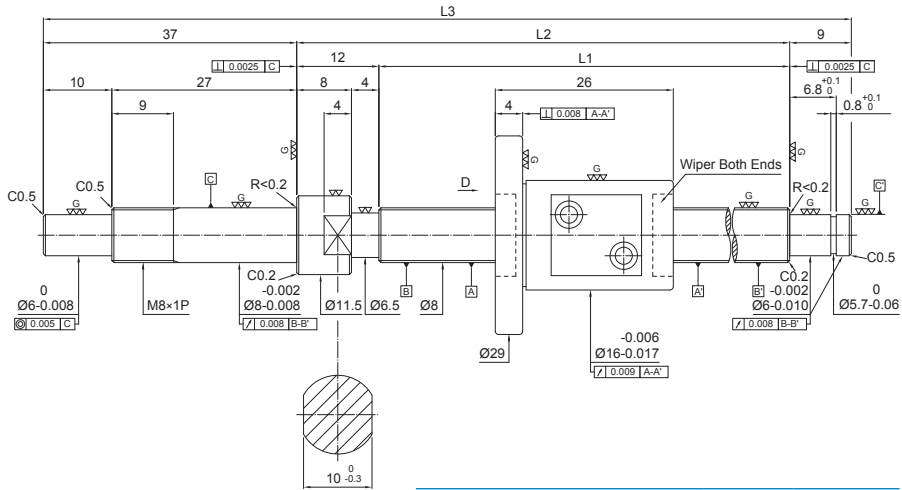

Specification of ball screw

Production Specification	With Preload	Without Preload
Number of Thread / Thread Direction	1/Right	
BCD	8.3	
Lead	2	
Ball Dia.	1.588	
Effective Turns (Circuit × Row)	2.5 × 1	
Lead Angle	4.39	
Dynamic Rate Load Ca (kgf)	190	
Static Rate Load Co (kgf)	290	
Axial Play	0	0.005 or less
Preloading Torque (kgf-cm)	0.01~0.2	0.05 or less

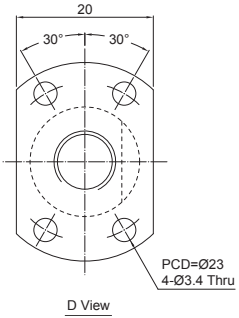

Unit:mm

Model No.	Screw Spindle (Shaft) Length			Accuracy Grade	Lead Accuracy		
	L1	L2	L3		Specified Travel (T)	Accumulated reference lead deviation E	Lead Deriation in random 300mm e ₃₀₀
FSM0802-C3-1R-0138	80	92	138	3	0	0.012	0.008
FSM0802-C3-1R-0168	110	122	168	3	0	0.012	0.008
FSM0802-C3-1R-0198	140	152	198	3	0	0.012	0.008
FSM0802-C3-1R-0248	190	202	248	3	0	0.012	0.008

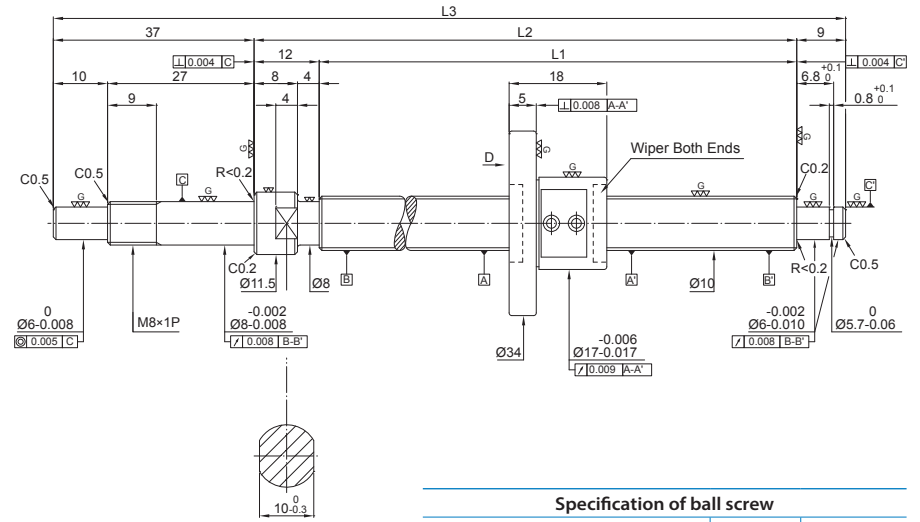

Specification of ball screw

Production Specification	With Preload	Without Preload
Number of Thread / Thread Direction	1/Right	
BCD	10.1	
Lead	1	
Ball Dia.	0.8	
Effective Turns (Circuit × Row)	2.5 × 1	
Lead Angle	1.8	
Dynamic Rate Load Ca (kgf)	73	
Static Rate Load Co (kgf)	180	
Axial Play	0	0.005 or less
Preloading Torque (kgf-cm)	0.01~0.3	0.05 or less

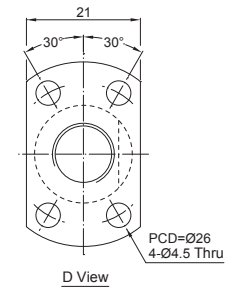

Unit:mm

Model No.	Screw Spindle (Shaft) Length			Accuracy Grade	Lead Accuracy		
	L1	L2	L3		Specified Travel (T)	Accumulated reference lead deviation E	Lead Deriation in random 300mm e ₃₀₀
FSM1001-C3-1R-0168	110	122	168	3	0	0.012	0.008
FSM1001-C3-1R-0218	160	172	218	3	0	0.012	0.008
FSM1001-C3-1R-0268	210	222	268	3	0	0.012	0.008
FSM1001-C3-1R-0318	260	272	318	3	0	0.012	0.008
FSM1001-C3-1R-0368	310	322	368	3	0	0.013	0.008

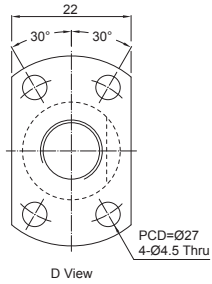
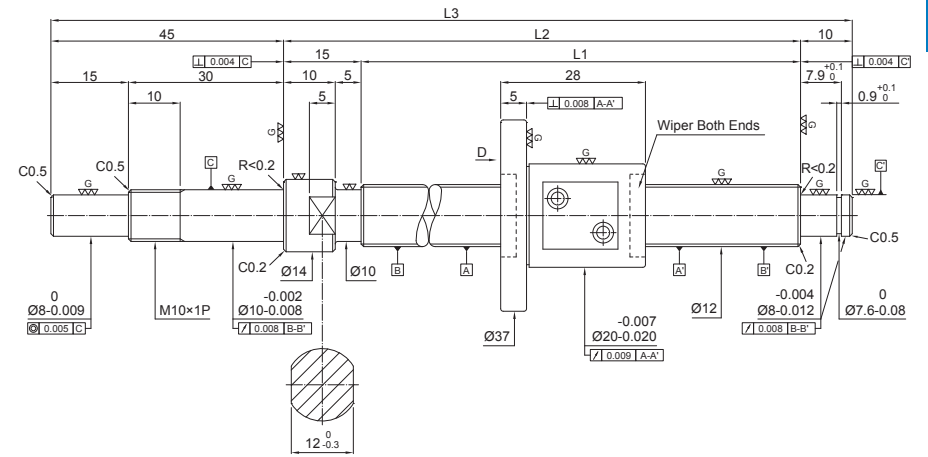
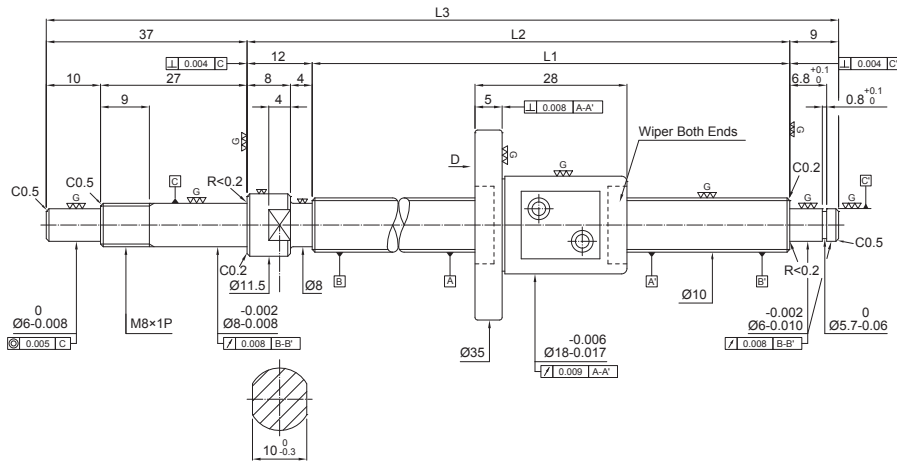

Specification of ball screw		
Production Specification	With Preload	Without Preload
Number of Thread / Thread Direction	1/Right	
BCD	10.3	
Lead	2	
Ball Dia.	1.588	
Effective Turns (Circuit × Row)	2.5 × 1	
Lead Angle	3.54	
Dynamic Rate Load Ca (kgf)	220	
Static Rate Load Co (kgf)	370	
Axial Play	0	0.005 or less
Preloading Torque (kgf-cm)	0.01~0.3	0.05 or less

Unit:mm

Model No.	Screw Spindle (Shaft) Length			Accuracy Grade	Lead Accuracy		
	L1	L2	L3		Specified Travel (T)	Accumulated reference lead deviation E	Lead Deriation in random 300mm e ₃₀₀
FSM1002-C3-1R-0168	110	122	168	3	0	0.012	0.008
FSM1002-C3-1R-0218	160	172	218	3	0	0.012	0.008
FSM1002-C3-1R-0268	210	222	268	3	0	0.012	0.008
FSM1002-C3-1R-0318	260	272	318	3	0	0.012	0.008
FSM1002-C3-1R-0368	310	322	368	3	0	0.012	0.008

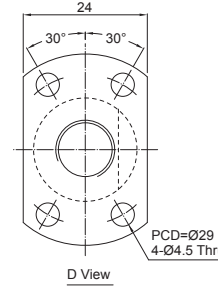

Specification of ball screw		
Production Specification	With Preload	Without Preload
Number of Thread / Thread Direction	1/Right	
BCD	12.3	
Lead	2	
Ball Dia.	1.588	
Effective Turns (Circuit × Row)	2.5 × 1	
Lead Angle	2.96	
Dynamic Rate Load Ca (kgf)	240	
Static Rate Load Co (kgf)	450	
Axial Play	0	0.005 or less
Preloading Torque (kgf-cm)	0.04~0.4	0.1 or less

Unit:mm

Model No.	Screw Spindle (Shaft) Length			Accuracy Grade	Lead Accuracy		
	L1	L2	L3		Specified Travel (T)	Accumulated reference lead deviation E	Lead Deriation in random 300mm e ₃₀₀
FSM1202-C3-1R-0180	110	125	180	3	0	0.012	0.008
FSM1202-C3-1R-0230	160	175	230	3	0	0.012	0.008
FSM1202-C3-1R-0280	210	225	280	3	0	0.012	0.008
FSM1202-C3-1R-0330	260	275	330	3	0	0.012	0.008
FSM1202-C3-1R-0380	310	325	380	3	0	0.012	0.008

FSMC Miniature Ballscrews

Screw Dia.Ø16 Lead02

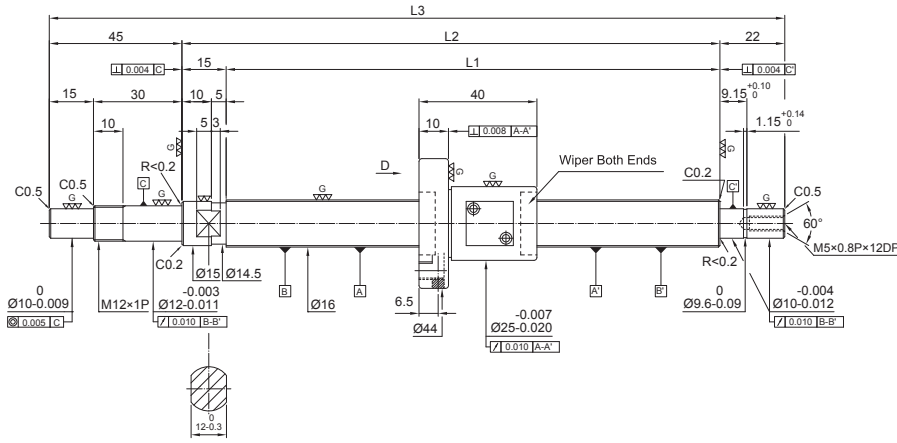

Specification of ball screw

Production Specification	With Preload	Without Preload
Number of Thread / Thread Direction	1/Right	
BCD	16.3	
Lead	2	
Ball Dia.	1.588	
Effective Turns (Circuit × Row)	3.5 × 1	
Lead Angle	2.24	
Dynamic Rate Load Ca (kgf)	360	
Static Rate Load Co (kgf)	850	
Axial Play	0	0.005 or less
Preloading Torque (kgf-cm)	0.05~0.5	0.15 or less

Unit:mm

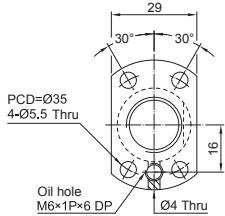

PMI Precision Ground BallScrew

Standard Type Series

Standard ballscrews FSWC

Screw Dia.Ø12 Lead05

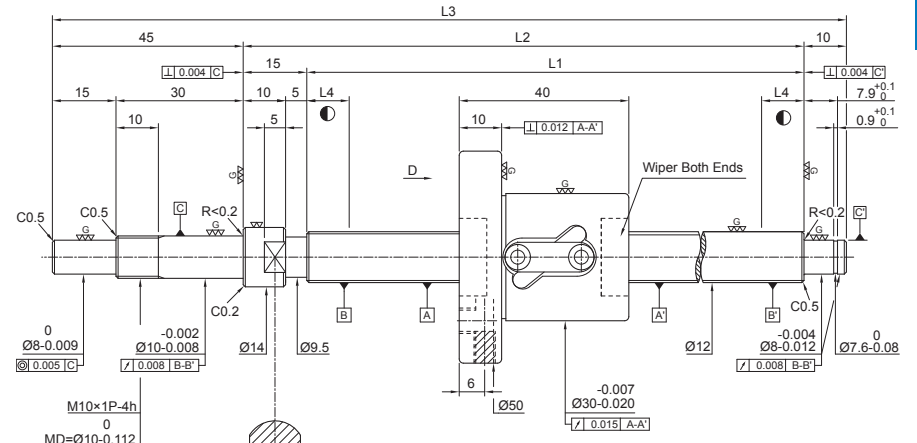

Specification of ball screw

Production Specification	With Preload	Without Preload
Number of Thread / Thread Direction	1/Right	
BCD	12.4	
Lead	5	
Ball Dia.	2.381	
Effective Turns (Circuit × Row)	2.5 × 1	
Lead Angle	7.31	
Dynamic Rate Load Ca (kgf)	380	
Static Rate Load Co (kgf)	640	
Axial Play	0	0.005 or less
Preloading Torque (kgf-cm)	0.01~0.45	0.1 or less

Unit:mm

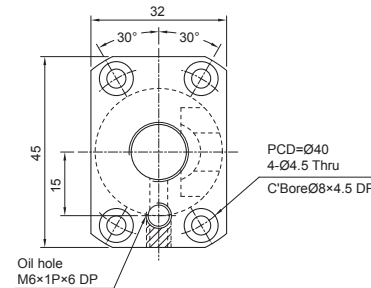

Model No.	Screw Spindle (Shaft) Length			Accuracy Grade	Lead Accuracy		
	L1	L2	L3		Specified Travel (T)	Accumulated reference lead deviation E	Lead Deriation in random 300mm e ₃₀₀
FSM1602-C3-1R-0221	139	154	221	3	0	0.012	0.008
FSM1602-C3-1R-0271	189	204	271	3	0	0.012	0.008
FSM1602-C3-1R-0321	239	254	321	3	0	0.012	0.008
FSM1602-C3-1R-0371	289	304	371	3	0	0.012	0.008
FSM1602-C3-1R-0471	389	404	471	3	0	0.013	0.008

Model No.	Screw Spindle (Shaft) Length				Accuracy Grade	Lead Accuracy	
	L1	L2	L3	L4		Accumulated reference lead deviation E	Lead Deriation in random 300mm e ₃₀₀
1R12-05B1-1FSWC-110-180-0.008	110	125	180	10	3	0.012	0.008
1R12-05B1-1FSWC-160-230-0.008	160	175	230	10	3	0.012	0.008
1R12-05B1-1FSWC-210-280-0.008	210	225	280	10	3	0.012	0.008
1R12-05B1-1FSWC-260-330-0.008	260	275	330	10	3	0.012	0.008
1R12-05B1-1FSWC-310-380-0.008	310	325	380	10	3	0.012	0.008
1R12-05B1-1FSWC-410-480-0.008	410	425	480	15	3	0.013	0.008
1R12-05B1-1FSWC-510-580-0.008	510	525	580	15	3	0.015	0.008

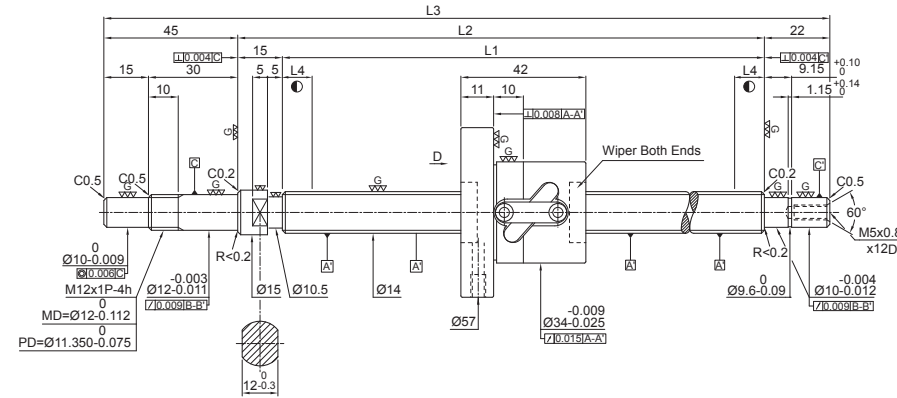
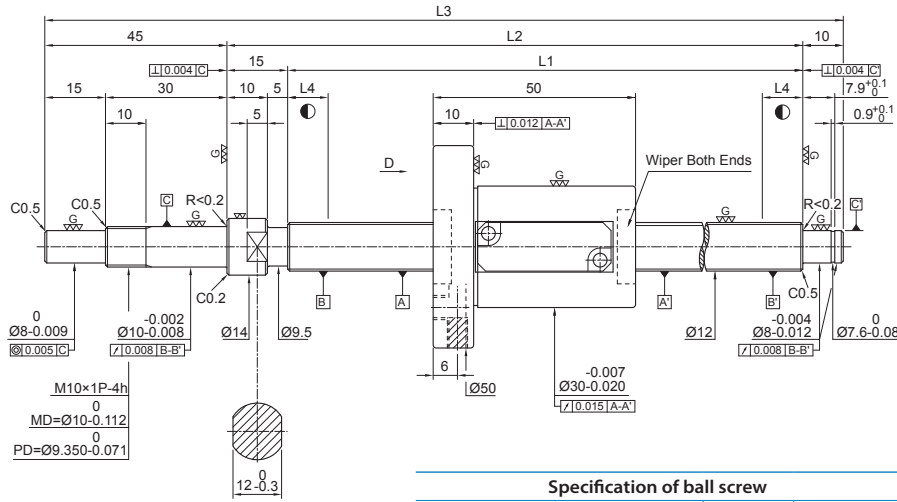

Specification of ball screw		
Production Specification	With Preload	Without Preload
Number of Thread / Thread Direction	1/Right	
BCD	12.4	
Lead	10	
Ball Dia.	2.381	
Effective Turns (Circuit × Row)	2.5 × 1	
Lead Angle	14.4	
Dynamic Rate Load Ca (kgf)	420	
Static Rate Load Co (kgf)	720	
Axial Play	0	0.005 or less
Preloading Torque (kgf-cm)	0.1~0.5	0.1 or less

Specification of ball screw		
Production Specification	With Preload	Without Preload
Number of Thread / Thread Direction	1/Right	
BCD	14.6	
Lead	5	
Ball Dia.	3.175	
Effective Turns (Circuit × Row)	2.5 × 1	
Lead Angle	6.22	
Dynamic Rate Load Ca (kgf)	675	
Static Rate Load Co (kgf)	1145	
Axial Play	0	0.005 or less
Preloading Torque (kgf-cm)	0.15~0.7	0.2 or less

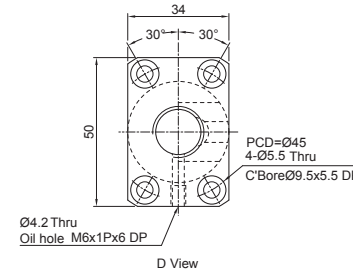
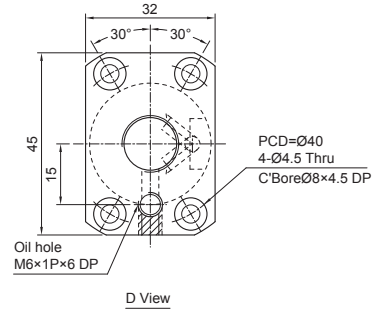

單位:mm

Unit:mm

Model No.	Screw Spindle (Shaft) Length				Accuracy Grade	Lead Accuracy	
	L1	L2	L3	L4		Accumulated reference lead deviation E	Lead Deriation in random 300mm e ₃₀₀
1R12-10B1-1FSWE-160-230-0.008	160	175	230	10	3	0.012	0.008
1R12-10B1-1FSWE-210-280-0.008	210	225	280	10	3	0.012	0.008
1R12-10B1-1FSWE-310-380-0.008	310	325	380	15	3	0.012	0.008
1R12-10B1-1FSWE-410-480-0.008	410	425	480	15	3	0.013	0.008
1R12-10B1-1FSWE-510-580-0.008	510	525	580	15	3	0.015	0.008

Model No.	Screw Spindle (Shaft) Length				Accuracy Grade	Lead Accuracy	
	L1	L2	L3	L4		Accumulated reference lead deviation E	Lead Deriation in random 300mm e ₃₀₀
1R14-05B1-1FSWC-189-271-0.008	189	204	271	10	3	0.012	0.008
1R14-05B1-1FSWC-239-321-0.008	239	254	321	10	3	0.012	0.008
1R14-05B1-1FSWC-339-421-0.008	339	354	421	15	3	0.012	0.008
1R14-05B1-1FSWC-439-521-0.008	439	454	521	15	3	0.012	0.008
1R14-05B1-1FSWC-539-621-0.008	539	554	621	15	3	0.012	0.008
1R14-05B1-1FSWC-689-771-0.008	689	704	771	15	3	0.013	0.008

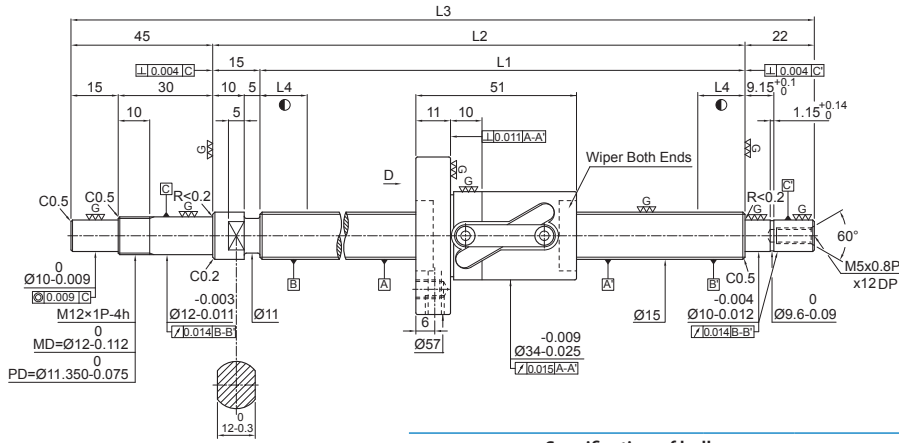

Specification of ball screw

Production Specification	With Preload	Without Preload
Number of Thread / Thread Direction	1/Right	
BCD	15.6	
Lead	10	
Ball Dia.	3.175	
Effective Turns (Circuit × Row)	2.5 × 1	
Lead Angle	11.53	
Dynamic Rate Load Ca (kgf)	680	
Static Rate Load Co (kgf)	1210	
Axial Play	0	0.005 or less
Preloading Torque (kgf-cm)	0.1~0.79	0.24 or less

Unit:mm

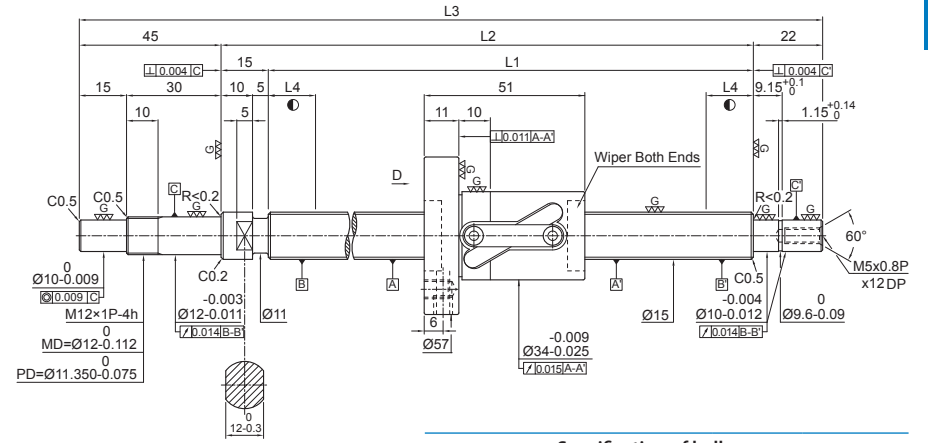

Specification of ball screw

Production Specification	With Preload	Without Preload
Number of Thread / Thread Direction	1/Right	
BCD	15.6	
Lead	10	
Ball Dia.	3.175	
Effective Turns (Circuit × Row)	2.5 × 1	
Lead Angle	11.53	
Dynamic Rate Load Ca (kgf)	680	
Static Rate Load Co (kgf)	1210	
Axial Play	0	0.005 or less
Preloading Torque (kgf-cm)	0.1~0.79	0.24 or less

Unit:mm

Model No.	Screw Spindle (Shaft) Length				Accuracy Grade	Lead Accuracy	
	L1	L2	L3	L4		Accumulated reference lead deviation E	Lead Deriation in random 300mm ϵ_{300}
1R15-10B1-1FSWC-189-271-0.018	189	204	271	10	5	0.023	0.018
1R15-10B1-1FSWC-239-321-0.018	239	254	321	10	5	0.023	0.018
1R15-10B1-1FSWC-289-371-0.018	289	304	371	15	5	0.023	0.018
1R15-10B1-1FSWC-339-421-0.018	339	354	421	15	5	0.023	0.018
1R15-10B1-1FSWC-389-471-0.018	389	404	471	15	5	0.025	0.018
1R15-10B1-1FSWC-439-521-0.018	439	454	521	15	5	0.025	0.018
1R15-10B1-1FSWC-489-571-0.018	489	504	571	15	5	0.027	0.018

Model No.	Screw Spindle (Shaft) Length				Accuracy Grade	Lead Accuracy	
	L1	L2	L3	L4		Accumulated reference lead deviation E	Lead Deriation in random 300mm ϵ_{300}
1R15-10B1-1FSWC-539-621-0.018	539	554	621	15	5	0.027	0.018
1R15-10B1-1FSWC-589-671-0.018	589	604	671	15	5	0.030	0.018
1R15-10B1-1FSWC-639-721-0.018	639	654	721	15	5	0.030	0.018
1R15-10B1-1FSWC-689-771-0.018	689	704	771	15	5	0.035	0.018
1R15-10B1-1FSWC-789-871-0.018	789	804	871	15	5	0.035	0.018
1R15-10B1-1FSWC-889-971-0.018	889	904	971	15	5	0.040	0.018
1R15-10B1-1FSWC-1089-1171-0.018	1089	1104	1171	15	5	0.046	0.018

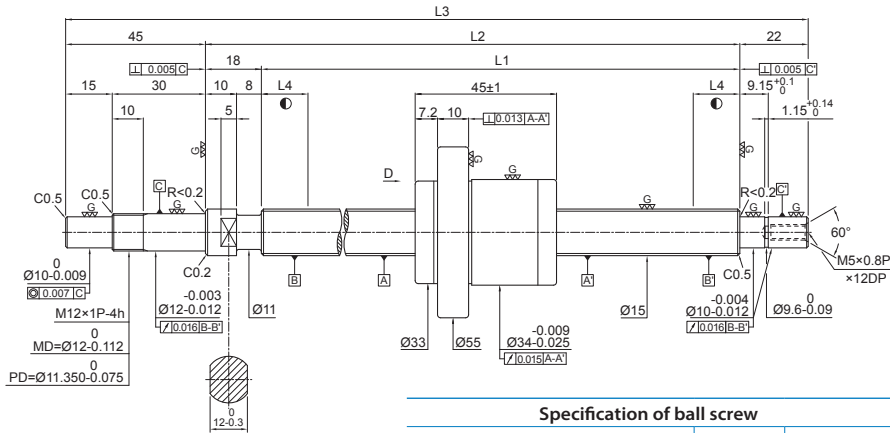

Specification of ball screw		
Production Specification	With Preload	Without Preload
Number of Thread / Thread Direction	1/Right	
BCD	15.6	
Lead	20	
Ball Dia.	3.175	
Effective Turns (Circuit × Row)	1.8 × 1	
Lead Angle	22.2	
Dynamic Rate Load Ca (kgf)	780	
Static Rate Load Co (kgf)	1400	
Axial Play	0	0.005 or less
Preloading Torque (kgf-cm)	0.15~0.8	0.24 or less

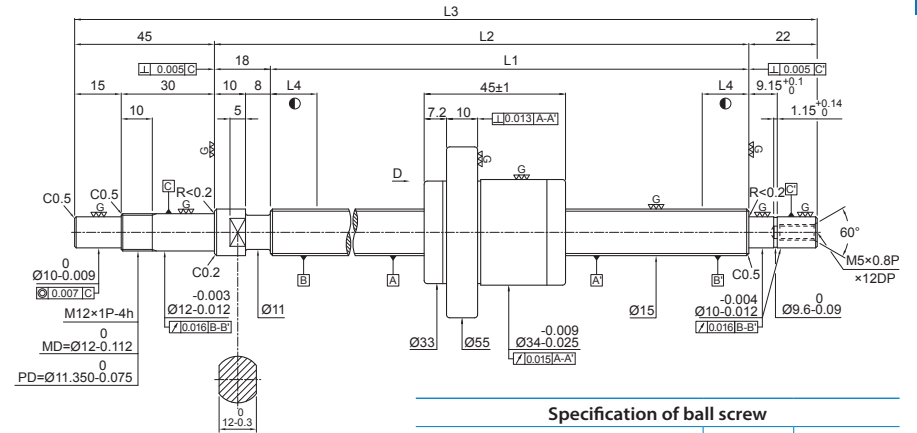

Specification of ball screw		
Production Specification	With Preload	Without Preload
Number of Thread / Thread Direction	1/Right	
BCD	15.6	
Lead	20	
Ball Dia.	3.175	
Effective Turns (Circuit × Row)	1.8 × 1	
Lead Angle	22.2	
Dynamic Rate Load Ca (kgf)	780	
Static Rate Load Co (kgf)	1400	
Axial Play	0	0.005 or less
Preloading Torque (kgf-cm)	0.15~0.8	0.24 or less

Unit: mm

Unit: mm

Model No.	Screw Spindle (Shaft) Length				Accuracy Grade	Lead Accuracy	
	L1	L2	L3	L4		Accumulated reference lead deviation E	Lead Deriation in random 300mm e_{300}
1R15-20A1-1FSKC-186-271-0.018	186	204	271	10	5	0.023	0.018
1R15-20A1-1FSKC-236-321-0.018	236	254	321	10	5	0.023	0.018
1R15-20A1-1FSKC-286-371-0.018	286	304	371	15	5	0.023	0.018
1R15-20A1-1FSKC-336-421-0.018	336	354	421	15	5	0.023	0.018
1R15-20A1-1FSKC-386-471-0.018	386	404	471	15	5	0.025	0.018
1R15-20A1-1FSKC-436-521-0.018	436	454	521	15	5	0.025	0.018
1R15-20A1-1FSKC-486-571-0.018	486	504	571	15	5	0.027	0.018

Model No.	Screw Spindle (Shaft) Length				Accuracy Grade	Lead Accuracy	
	L1	L2	L3	L4		Accumulated reference lead deviation E	Lead Deriation in random 300mm e_{300}
1R15-20A1-1FSKC-536-621-0.018	536	554	621	15	5	0.027	0.018
1R15-20A1-1FSKC-586-671-0.018	586	604	671	15	5	0.030	0.018
1R15-20A1-1FSKC-636-721-0.018	636	654	721	15	5	0.030	0.018
1R15-20A1-1FSKC-686-771-0.018	686	704	771	15	5	0.030	0.018
1R15-20A1-1FSKC-786-871-0.018	786	804	871	15	5	0.035	0.018
1R15-20A1-1FSKC-886-971-0.018	886	904	971	15	5	0.040	0.018
1R15-20A1-1FSKC-1086-1171-0.018	1086	1104	1171	15	5	0.046	0.018

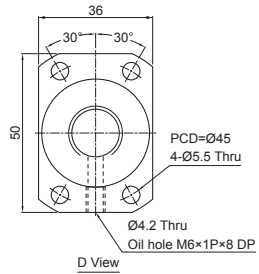
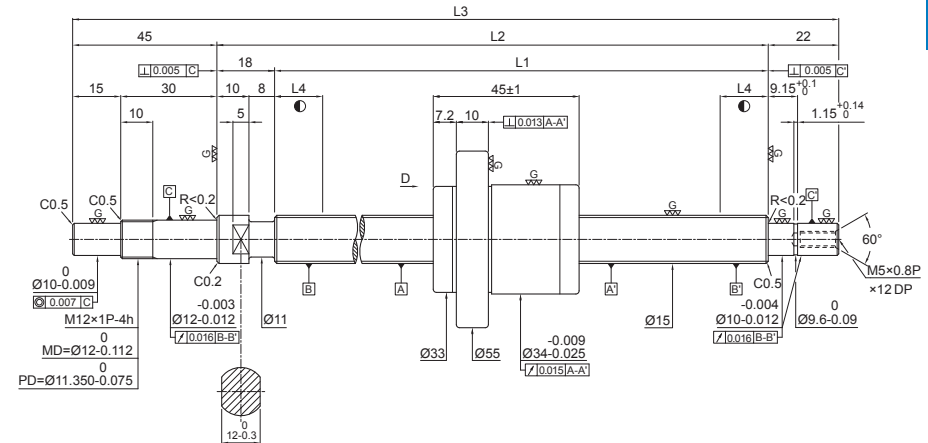
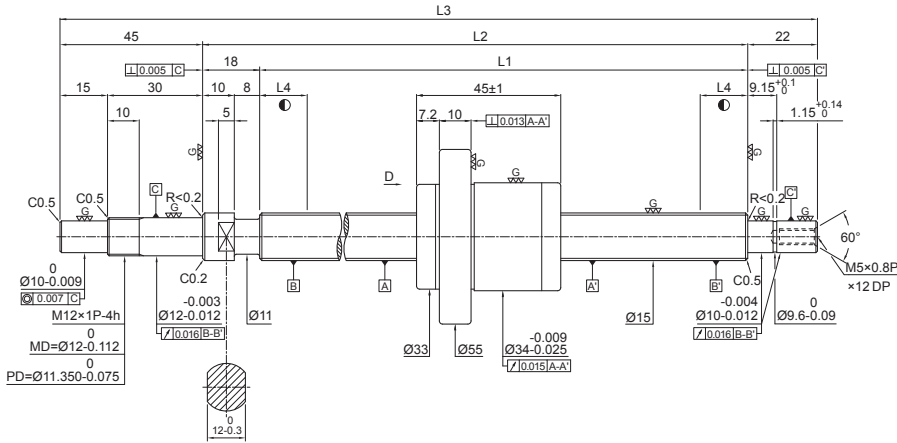

Specification of ball screw		
Production Specification	With Preload	Without Preload
Number of Thread / Thread Direction	2/Right	
BCD	15.6	
Lead	20	
Ball Dia.	3.175	
Effective Turns (Circuit × Row)	1.8 × 2	
Lead Angle	22.2	
Dynamic Rate Load Ca (kgf)	1400	
Static Rate Load Co (kgf)	2800	
Axial Play	0	0.005 or less
Preloading Torque (kgf-cm)	0.2~0.9	-

Unit:mm

Model No.	Screw Spindle (Shaft) Length				Accuracy Grade	Lead Accuracy	
	L1	L2	L3	L4		Accumulated reference lead deviation E	Lead Deriation in random 300mm e ₃₀₀
2R15-20A1-1FSKC-236-321-0.018	236	254	321	10	5	0.023	0.018
2R15-20A1-1FSKC-286-371-0.018	286	304	371	10	5	0.023	0.018
2R15-20A1-1FSKC-336-421-0.018	336	354	421	15	5	0.023	0.018
2R15-20A1-1FSKC-386-471-0.018	386	404	471	15	5	0.025	0.018
2R15-20A1-1FSKC-436-521-0.018	436	454	521	15	5	0.025	0.018
2R15-20A1-1FSKC-486-571-0.018	486	504	571	15	5	0.027	0.018

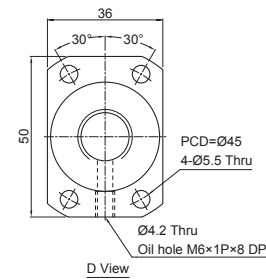

Specification of ball screw		
Production Specification	With Preload	Without Preload
Number of Thread / Thread Direction	2/Right	
BCD	15.6	
Lead	20	
Ball Dia.	3.175	
Effective Turns (Circuit × Row)	1.8 × 2	
Lead Angle	22.2	
Dynamic Rate Load Ca (kgf)	1400	
Static Rate Load Co (kgf)	2800	
Axial Play	0	0.005 or less
Preloading Torque (kgf-cm)	0.2~0.9	-

Unit:mm

Model No.	Screw Spindle (Shaft) Length				Accuracy Grade	Lead Accuracy	
	L1	L2	L3	L4		Accumulated reference lead deviation E	Lead Deriation in random 300mm e ₃₀₀
2R15-20A1-1FSKC-536-621-0.018	536	554	621	15	5	0.027	0.018
2R15-20A1-1FSKC-586-671-0.018	586	604	671	15	5	0.030	0.018
2R15-20A1-1FSKC-636-721-0.018	636	654	721	15	5	0.030	0.018
2R15-20A1-1FSKC-686-771-0.018	686	704	771	15	5	0.030	0.018
2R15-20A1-1FSKC-786-871-0.018	786	804	871	15	5	0.035	0.018
2R15-20A1-1FSKC-886-971-0.018	886	904	971	15	5	0.040	0.018

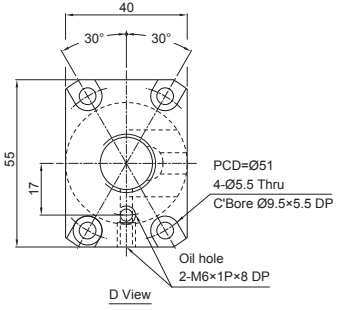
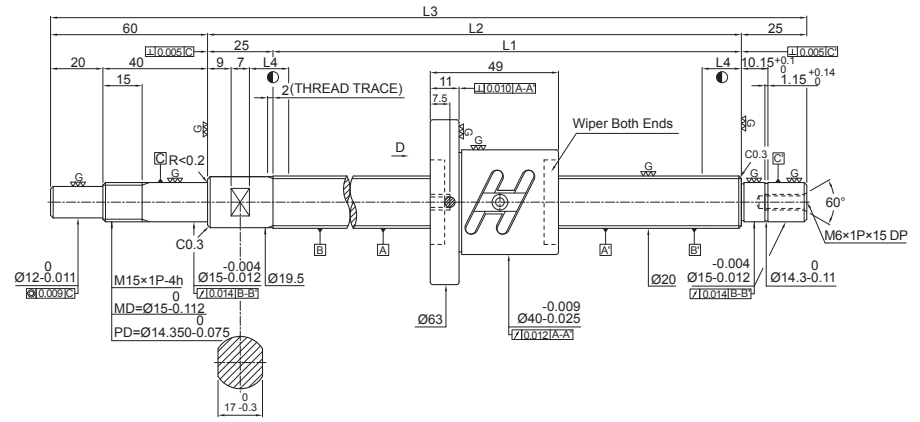
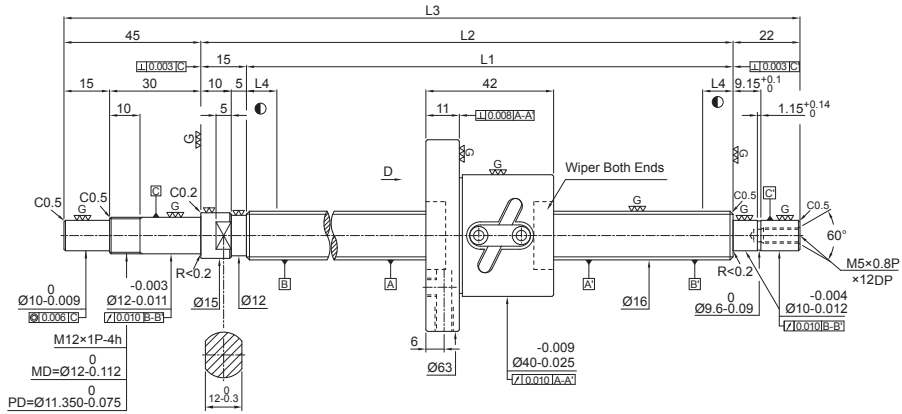

Specification of ball screw		
Production Specification	With Preload	Without Preload
Number of Thread / Thread Direction	1/Right	
BCD	16.6	
Lead	5	
Ball Dia.	3.175	
Effective Turns (Circuit x Row)	2.5 x 1	
Lead Angle	5.48	
Dynamic Rate Load Ca (kgf)	690	
Static Rate Load Co (kgf)	1270	
Axial Play	0	0.005 or less
Preloading Torque (kgf-cm)	0.15~0.8	0.2 or less

Unit: mm

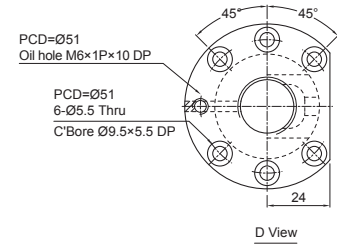

Specification of ball screw	
Production Specification	With Preload
Number of Thread / Thread Direction	1/Right
BCD	20.4
Lead	4
Ball Dia.	2.381
Effective Turns (Circuit x Row)	2.5 x 2
Lead Angle	3.57
Dynamic Rate Load Ca (kgf)	820
Static Rate Load Co (kgf)	2110
Axial Play	0
Preloading Torque (kgf-cm)	0.12~0.68

Unit: mm

Model No.	Screw Spindle (Shaft) Length				Accuracy Grade	Lead Accuracy	
	L1	L2	L3	L4		Accumulated reference lead deviation E	Lead Deriation in random 300mm e ₃₀₀
1R16-05B1-1FSWC-189-271-0.018	189	204	271	10	5	0.023	0.018
1R16-05B1-1FSWC-289-371-0.018	289	304	371	10	5	0.023	0.018
1R16-05B1-1FSWC-389-471-0.018	389	404	471	15	5	0.025	0.018
1R16-05B1-1FSWC-489-571-0.018	489	504	571	15	5	0.027	0.018
1R16-05B1-1FSWC-689-771-0.018	689	704	771	15	5	0.035	0.018
1R16-05B1-1FSWC-889-971-0.018	889	904	971	15	5	0.040	0.018

Model No.	Screw Spindle (Shaft) Length				Accuracy Grade	Lead Accuracy	
	L1	L2	L3	L4		Accumulated reference lead deviation E	Lead Deriation in random 300mm e ₃₀₀
1R20-04B2-1FSWC-225-335-0.018	225	250	335	10	5	0.023	0.018
1R20-04B2-1FSWC-275-385-0.018	275	300	385	10	5	0.023	0.018
1R20-04B2-1FSWC-375-485-0.018	375	400	485	15	5	0.025	0.018
1R20-04B2-1FSWC-475-585-0.018	475	500	585	15	5	0.027	0.018
1R20-04B2-1FSWC-575-685-0.018	575	600	685	15	5	0.030	0.018
1R20-04B2-1FSWC-675-785-0.018	675	700	785	15	5	0.035	0.018

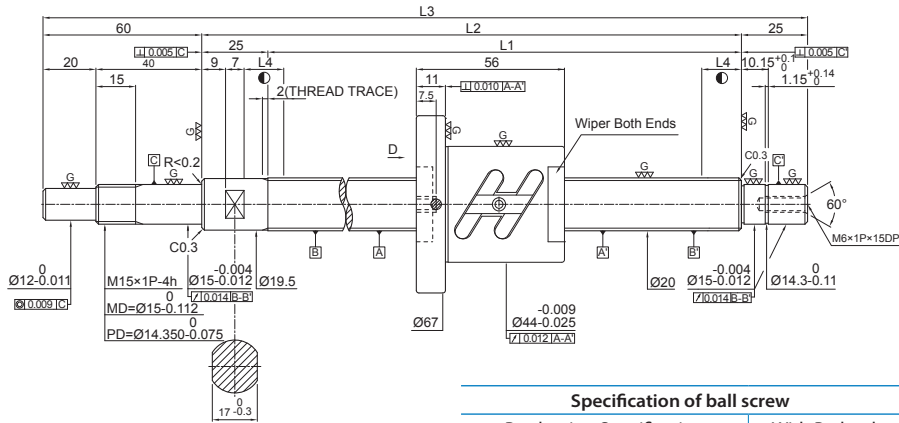

Specification of ball screw

Production Specification	With Preload
Number of Thread / Thread Direction	1/Right
BCD	20.6
Lead	5
Ball Dia.	3.175
Effective Turns (Circuit × Row)	2.5 × 2
Lead Angle	4.42
Dynamic Rate Load Ca (kgf)	1510
Static Rate Load Co (kgf)	3460
Axial Play	0
Preloading Torque (kgf-cm)	0.28~1.32

Unit: mm

Model No.	Screw Spindle (Shaft) Length				Accuracy Grade	Lead Accuracy	
	L1	L2	L3	L4		Accumulated reference lead deviation E	Lead Deriation in random 300mm ϵ_{300}
1R20-05B2-1FSWC-275-385-0.018	275	300	385	10	5	0.023	0.018
1R20-05B2-1FSWC-375-485-0.018	375	400	485	15	5	0.025	0.018
1R20-05B2-1FSWC-475-585-0.018	475	500	585	15	5	0.027	0.018
1R20-05B2-1FSWC-575-685-0.018	575	600	685	15	5	0.030	0.018
1R20-05B2-1FSWC-775-885-0.018	775	800	885	10	5	0.035	0.018

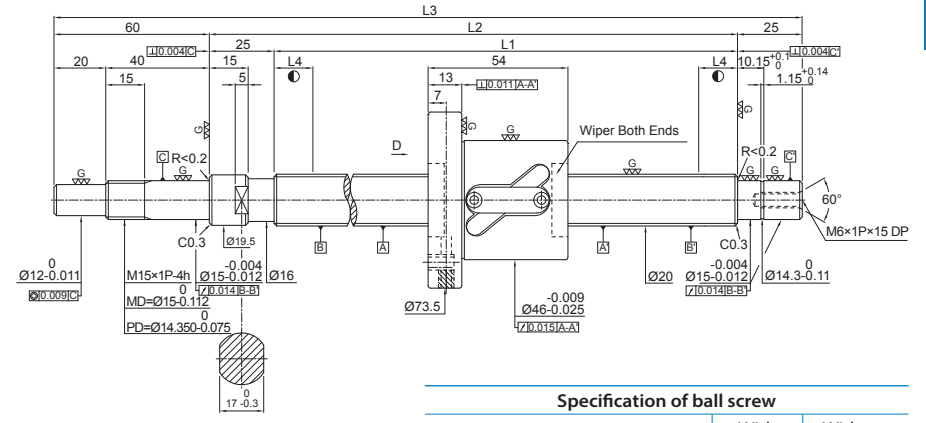

Specification of ball screw

Production Specification	With Preload	Without Preload
Number of Thread / Thread Direction	1/Right	
BCD	20.7	
Lead	10	
Ball Dia.	3.969	
Effective Turns (Circuit × Row)	2.5 × 1	
Lead Angle	8.74	
Dynamic Rate Load Ca (kgf)	1100	
Static Rate Load Co (kgf)	2120	
Axial Play	0	0.005 or less
Preloading Torque (kgf-cm)	0.36~1.44	0.3or less

Unit: mm

Model No.	Screw Spindle (Shaft) Length				Accuracy Grade	Lead Accuracy	
	L1	L2	L3	L4		Accumulated reference lead deviation E	Lead Deriation in random 300mm ϵ_{300}
1R20-10B1-1FSWC-389-499-0.018	389	414	499	10	5	0.025	0.018
1R20-10B1-1FSWC-489-599-0.018	489	514	599	15	5	0.027	0.018
1R20-10B1-1FSWC-589-699-0.018	589	614	699	15	5	0.030	0.018
1R20-10B1-1FSWC-689-799-0.018	689	714	799	15	5	0.035	0.018
1R20-10B1-1FSWC-789-899-0.018	789	814	899	15	5	0.035	0.018
1R20-10B1-1FSWC-889-999-0.018	889	914	999	15	5	0.040	0.018
1R20-10B1-1FSWC-989-1099-0.018	989	1014	1099	15	5	0.040	0.018
1R20-10B1-1FSWC-1089-1199-0.018	1089	1114	1199	15	5	0.046	0.018
1R20-10B1-1FSWC-1189-1299-0.018	1189	1214	1299	15	5	0.046	0.018
1R20-10B1-1FSWC-1289-1399-0.018	1289	1314	1399	15	5	0.046	0.018

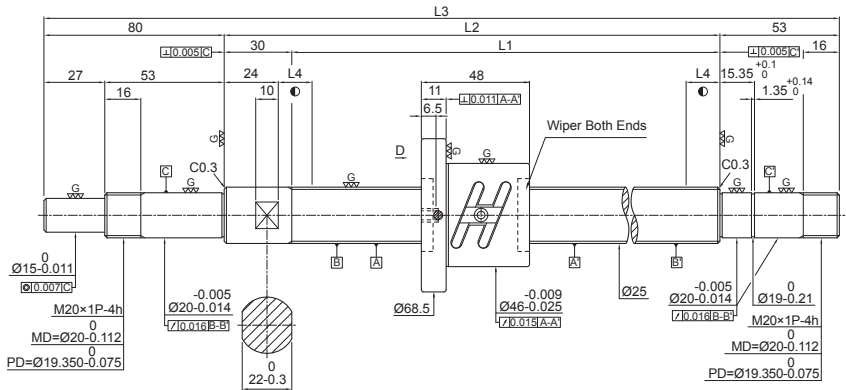

Specification of ball screw	
Production Specification	With Preload
Number of Thread / Thread Direction	1/Right
BCD	25.4
Lead	4
Ball Dia.	2.381
Effective Turns (Circuit × Row)	2.5 × 2
Lead Angle	2.87
Dynamic Rate Load Ca (kgf)	930
Static Rate Load Co (kgf)	2710
Axial Play	0
Preloading Torque (kgf-cm)	0.15~0.85

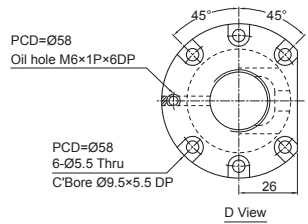

Unit:mm

Model No.	Screw Spindle (Shaft) Length				Accuracy Grade	Lead Accuracy	
	L1	L2	L3	L4		Accumulated reference lead deviation E	Lead Deriation in random 300mm ϵ_{300}
1R25-04B2-1FSWC-220-383-0.018	220	250	383	10	5	0.023	0.018
1R25-04B2-1FSWC-270-433-0.018	270	300	433	10	5	0.023	0.018
1R25-04B2-1FSWC-370-533-0.018	370	400	533	15	5	0.025	0.018
1R25-04B2-1FSWC-470-633-0.018	470	500	633	15	5	0.027	0.018
1R25-04B2-1FSWC-570-733-0.018	570	600	733	15	5	0.030	0.018
1R25-04B2-1FSWC-770-933-0.018	770	800	933	10	5	0.035	0.018

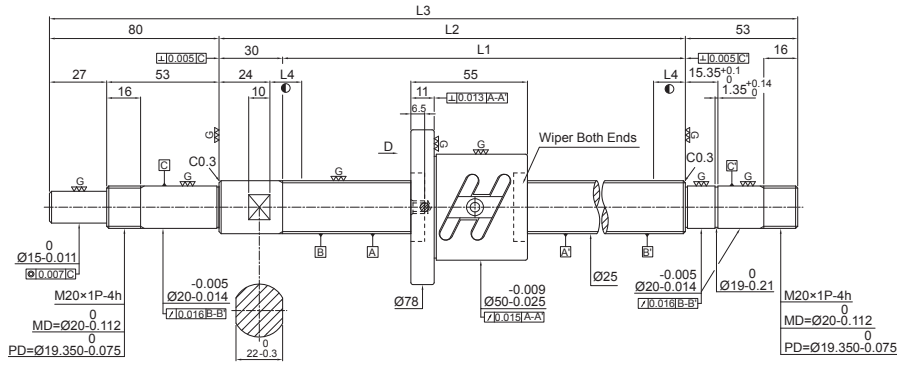

Specification of ball screw		
Production Specification	With Preload	Without Preload
Number of Thread / Thread Direction	1/Right	
BCD	25.6	
Lead	5	
Ball Dia.	3.175	
Effective Turns (Circuit × Row)	2.5 × 2	
Lead Angle	3.55	
Dynamic Rate Load Ca (kgf)	1650	
Static Rate Load Co (kgf)	4300	
Axial Play	0	0.005 or less
Preloading Torque (kgf-cm)	0.36~1.44	0.3 or less

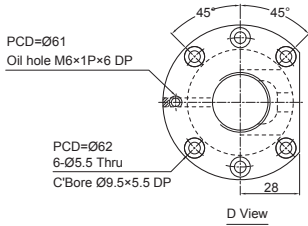

Unit:mm

Model No.	Screw Spindle (Shaft) Length				Accuracy Grade	Lead Accuracy	
	L1	L2	L3	L4		Accumulated reference lead deviation E	Lead Deriation in random 300mm ϵ_{300}
1R25-05B2-1FSWC-220-383-0.018	220	250	383	10	5	0.023	0.018
1R25-05B2-1FSWC-270-433-0.018	270	300	433	10	5	0.023	0.018
1R25-05B2-1FSWC-370-533-0.018	370	400	533	15	5	0.025	0.018
1R25-05B2-1FSWC-470-633-0.018	470	500	633	15	5	0.027	0.018
1R25-05B2-1FSWC-570-733-0.018	570	600	733	15	5	0.030	0.018
1R25-05B2-1FSWC-670-833-0.018	670	700	833	15	5	0.030	0.018
1R25-05B2-1FSWC-770-933-0.018	770	800	933	15	5	0.035	0.018
1R25-05B2-1FSWC-970-1133-0.018	970	1000	1133	15	5	0.040	0.018
1R25-05B2-1FSWC-1170-1333-0.018	1170	1200	1333	15	5	0.046	0.018

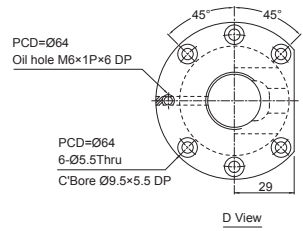
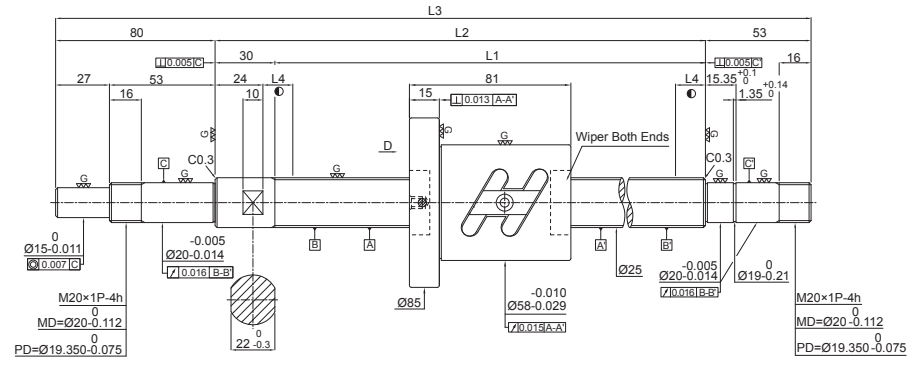
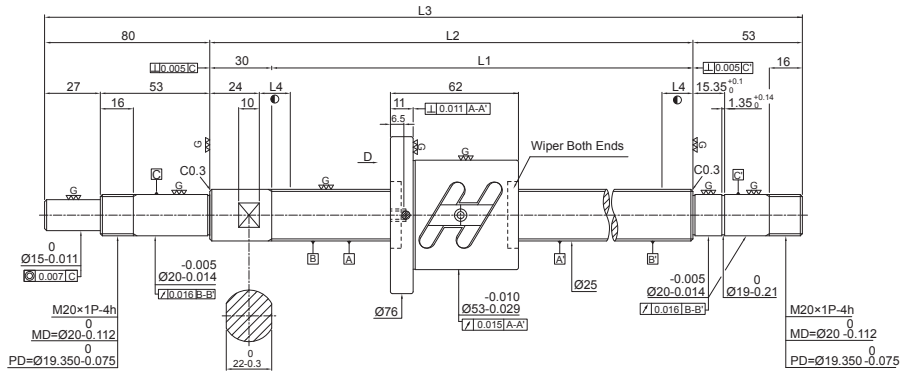

Specification of ball screw	
Production Specification	With Preload
Number of Thread / Thread Direction	1/Right
BCD	25.7
Lead	6
Ball Dia.	3.969
Effective Turns (Circuit x Row)	2.5 x 2
Lead Angle	4.25
Dynamic Rate Load Ca (kgf)	2190
Static Rate Load Co (kgf)	5360
Axial Play	0
Preloading Torque (kgf-cm)	0.42~2.4

Unit:mm

Model No.	Screw Spindle (Shaft) Length				Accuracy Grade	Lead Accuracy	
	L1	L2	L3	L4		Accumulated reference lead deviation E	Lead Deriation in random 300mm e ₃₀₀
1R25-06B2-1FSWC-370-533-0.018	370	400	533	15	5	0.025	0.018
1R25-06B2-1FSWC-570-733-0.018	570	600	733	15	5	0.030	0.018
1R25-06B2-1FSWC-770-933-0.018	770	800	933	15	5	0.035	0.018
1R25-06B2-1FSWC-1170-1333-0.018	1170	1200	1333	15	5	0.046	0.018

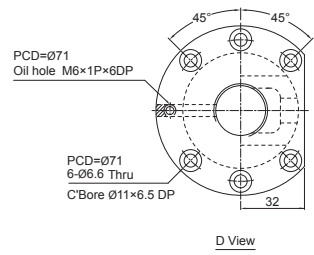

Specification of ball screw	
Production Specification	With Preload
Number of Thread / Thread Direction	1/Right
BCD	26
Lead	10
Ball Dia.	4.762
Effective Turns (Circuit x Row)	1.5 x 2
Lead Angle	6.98
Dynamic Rate Load Ca (kgf)	1820
Static Rate Load Co (kgf)	3840
Axial Play	0
Preloading Torque (kgf-cm)	0.42~2.4

Unit:mm

Model No.	Screw Spindle (Shaft) Length				Accuracy Grade	Lead Accuracy	
	L1	L2	L3	L4		Accumulated reference lead deviation E	Lead Deriation in random 300mm e ₃₀₀
1R25-10A2-1FSWC-370-533-0.018	370	400	533	10	5	0.025	0.018
1R25-10A2-1FSWC-570-733-0.018	570	600	733	10	5	0.030	0.018
1R25-10A2-1FSWC-770-933-0.018	770	800	933	15	5	0.035	0.018
1R25-10A2-1FSWC-970-1133-0.018	970	1000	1133	15	5	0.040	0.018
1R25-10A2-1FSWC-1170-1333-0.018	1170	1200	1333	15	5	0.046	0.018
1R25-10A2-1FSWC-1470-1633-0.018	1470	1500	1633	15	5	0.054	0.018

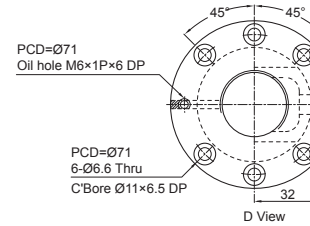
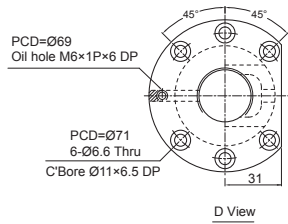
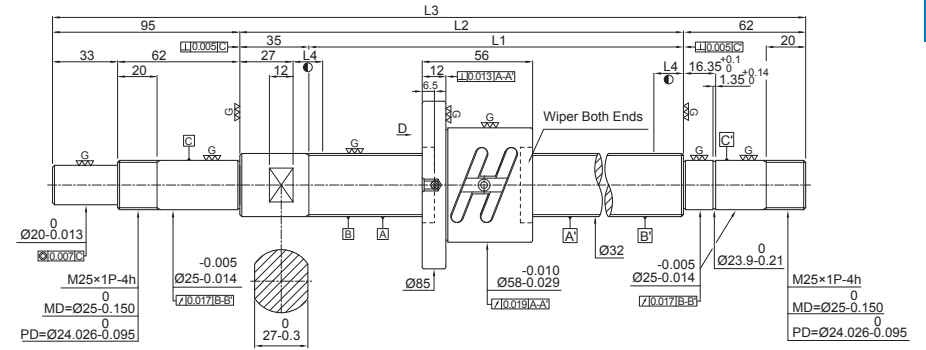
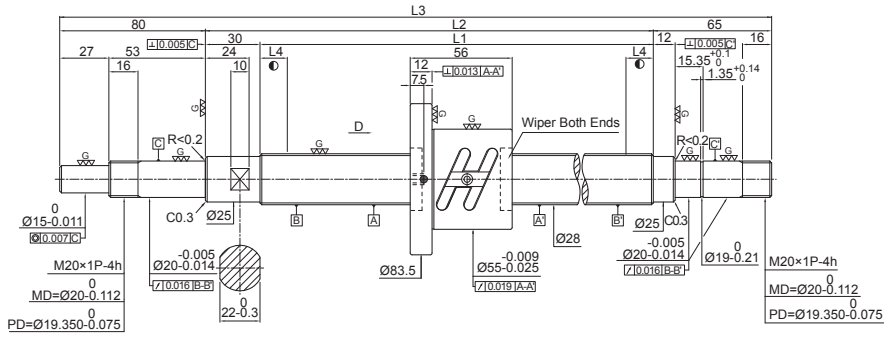

Specification of ball screw	
Production Specification	With Preload
Number of Thread / Thread Direction	1/Right
BCD	28.6
Lead	5
Ball Dia.	3.175
Effective Turns (Circuit × Row)	2.5 × 2
Lead Angle	3.19
Dynamic Rate Load Ca (kgf)	1720
Static Rate Load Co (kgf)	4940
Axial Play	0
Preloading Torque (kgf-cm)	0.3~1.7

Specification of ball screw	
Production Specification	With Preload
Number of Thread / Thread Direction	1/Right
BCD	32.6
Lead	5
Ball Dia.	3.175
Effective Turns (Circuit × Row)	2.5 × 2
Lead Angle	2.79
Dynamic Rate Load Ca (kgf)	1830
Static Rate Load Co (kgf)	5680
Axial Play	0
Preloading Torque (kgf-cm)	0.48~1.92

Unit:mm

Unit:mm

Model No.	Screw Spindle (Shaft) Length				Accuracy Grade	Lead Accuracy	
	L1	L2	L3	L4		Accumulated reference lead deviation E	Lead Deriation in random 300mm ϵ_{300}
1R28-05B2-1FSWC-270-445-0.018	270	300	445	10	5	0.023	0.018
1R28-05B2-1FSWC-370-545-0.018	370	400	545	15	5	0.023	0.018
1R28-05B2-1FSWC-470-645-0.018	470	500	645	15	5	0.023	0.018
1R28-05B2-1FSWC-558-733-0.018	558	588	733	15	5	0.023	0.018
1R28-05B2-1FSWC-758-933-0.018	758	788	933	15	5	0.025	0.018
1R28-05B2-1FSWC-958-1133-0.018	958	988	1133	15	5	0.025	0.018
1R28-05B2-1FSWC-1158-1333-0.018	1158	1188	1333	15	5	0.027	0.018

Model No.	Screw Spindle (Shaft) Length				Accuracy Grade	Lead Accuracy	
	L1	L2	L3	L4		Accumulated reference lead deviation E	Lead Deriation in random 300mm ϵ_{300}
1R32-05B2-1FSWC-265-457-0.018	265	300	457	10	5	0.023	0.018
1R32-05B2-1FSWC-365-557-0.018	365	400	557	15	5	0.025	0.018
1R32-05B2-1FSWC-465-657-0.018	465	500	657	15	5	0.027	0.018
1R32-05B2-1FSWC-565-757-0.018	565	600	757	15	5	0.030	0.018
1R32-05B2-1FSWC-665-857-0.018	665	700	857	15	5	0.030	0.018
1R32-05B2-1FSWC-765-957-0.018	765	800	957	15	5	0.035	0.018
1R32-05B2-1FSWC-965-1157-0.018	965	1000	1157	15	5	0.040	0.018
1R32-05B2-1FSWC-1165-1357-0.018	1165	1200	1357	15	5	0.046	0.018
1R32-05B2-1FSWC-1465-1657-0.018	1465	1500	1657	15	5	0.054	0.018

FSWC

Standard ballscrews
Screw Dia. $\varnothing 32$ Lead 06

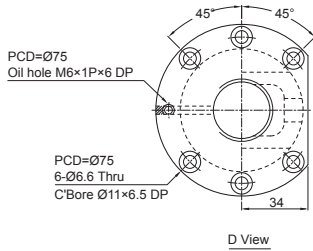
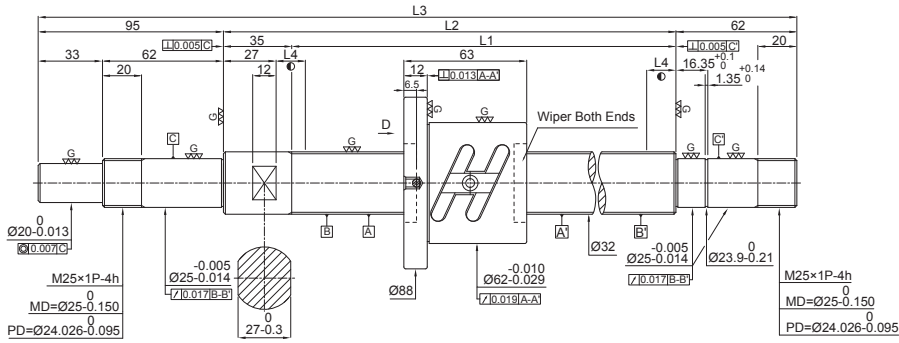

Specification of ball screw

Production Specification	With Preload
Number of Thread / Thread Direction	1/Right
BCD	32.7
Lead	6
Ball Dia.	3.969
Effective Turns (Circuit × Row)	2.5 × 2
Lead Angle	3.34
Dynamic Rate Load Ca (kgf)	2410
Static Rate Load Co (kgf)	6900
Axial Play	0
Preloading Torque (kgf-cm)	0.48~2.72

Unit: mm

Model No.	Screw Spindle (Shaft) Length				Accuracy Grade	Lead Accuracy	
	L1	L2	L3	L4		Accumulated reference lead deviation E	Lead Deriation in random 300mm e_{300}
1R32-06B2-1FSWC-365-557-0.018	365	400	557	15	5	0.025	0.018
1R32-06B2-1FSWC-565-757-0.018	565	600	757	15	5	0.030	0.018
1R32-06B2-1FSWC-765-957-0.018	765	800	957	15	5	0.035	0.018
1R32-06B2-1FSWC-965-1157-0.018	965	1000	1157	15	5	0.040	0.018
1R32-06B2-1FSWC-1165-1357-0.018	1165	1200	1357	15	5	0.046	0.018
1R32-06B2-1FSWC-1465-1657-0.018	1465	1500	1657	15	5	0.054	0.018

FOWC

Standard ballscrews
Screw Dia. $\varnothing 28$ Lead 05

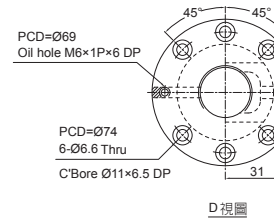
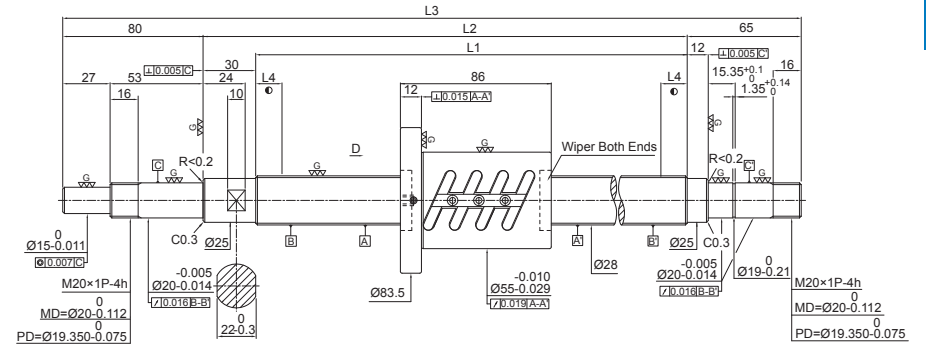

Specification of ball screw

Production Specification	With Preload
Number of Thread / Thread Direction	1/Right
BCD	28.6
Lead	5
Ball Dia.	3.175
Effective Turns (Circuit × Row)	2.5 × 2(2)
Lead Angle	3.19
Dynamic Rate Load Ca (kgf)	1720
Static Rate Load Co (kgf)	4940
Axial Play	0
Preloading Torque (kgf-cm)	1.1~3.3

Unit: mm

Model No.	Screw Spindle (Shaft) Length				Accuracy Grade	Lead Accuracy	
	L1	L2	L3	L4		Accumulated reference lead deviation E	Lead Deriation in random 300mm e_{300}
1R28-05B2-1FOWC-270-445-0.018	270	300	445	10	5	0.023	0.018
1R28-05B2-1FOWC-370-545-0.018	370	400	545	15	5	0.025	0.018
1R28-05B2-1FOWC-470-645-0.018	470	500	645	15	5	0.027	0.018
1R28-05B2-1FOWC-558-733-0.018	558	588	733	15	5	0.030	0.018
1R28-05B2-1FOWC-758-933-0.018	758	788	933	15	5	0.035	0.018
1R28-05B2-1FOWC-958-1133-0.018	958	988	1133	15	5	0.040	0.018
1R28-05B2-1FOWC-1158-1333-0.018	1158	1188	1333	15	5	0.046	0.018

FOWC Standard ballscrews
Screw Dia. Ø32 Lead05

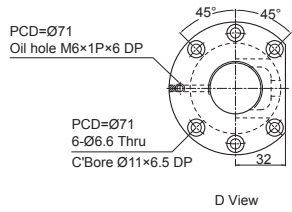
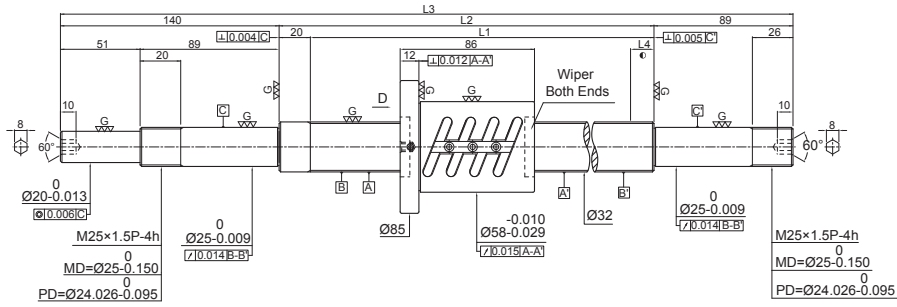

Specification of ball screw	
Production Specification	With Preload
Number of Thread / Thread Direction	1/Right
BCD	32.6
Lead	5
Ball Dia.	3.175
Effective Turns (Circuit x Row)	2.5 x 2(2)
Lead Angle	2.79
Dynamic Rate Load Ca (kgf)	1830
Static Rate Load Co (kgf)	5680
Axial Play	0
Preloading Torque (kgf-cm)	1.2~3.6

Unit:mm

Model No.	Screw Spindle (Shaft) Length				Accuracy Grade	Lead Accuracy	
	L1	L2	L3	L4		Accumulated reference lead deviation E	Lead Deriation in random 300mm e_{300}
1R32-05B2-1FOWC-280-529-0.018	280	300	529	10	5	0.023	0.018
1R32-05B2-1FOWC-380-629-0.018	380	400	629	15	5	0.025	0.018
1R32-05B2-1FOWC-480-729-0.018	480	500	729	15	5	0.027	0.018
1R32-05B2-1FOWC-580-829-0.018	580	600	829	15	5	0.030	0.018
1R32-05B2-1FOWC-680-929-0.018	680	700	929	15	5	0.035	0.018
1R32-05B2-1FOWC-780-1029-0.018	780	800	1029	15	5	0.035	0.018
1R32-05B2-1FOWC-980-1229-0.018	980	1000	1229	15	5	0.040	0.018
1R32-05B2-1FOWC-1180-1429-0.018	1180	1200	1429	15	5	0.046	0.018
1R32-05B2-1FOWC-1480-1729-0.018	1480	1500	1729	15	5	0.054	0.018

Standard ballscrews **FOWC**
Screw Dia. Ø32 Lead06

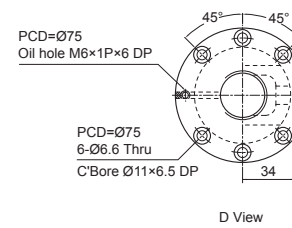
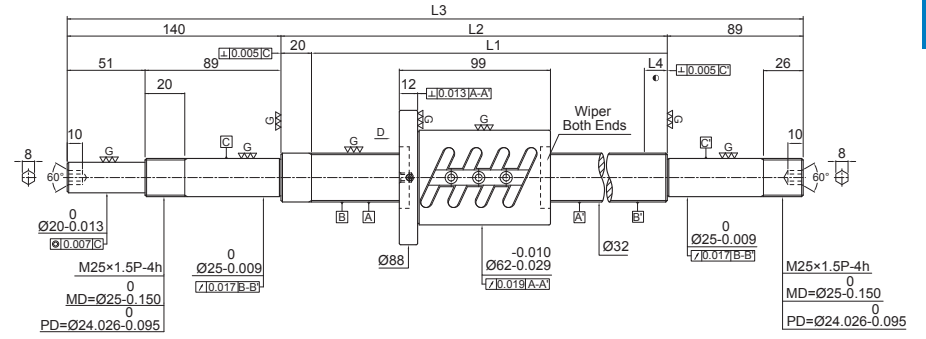

Specification of ball screw	
Production Specification	With Preload
Number of Thread / Thread Direction	1/Right
BCD	32.7
Lead	6
Ball Dia.	3.969
Effective Turns (Circuit x Row)	2.5 x 2(2)
Lead Angle	3.34
Dynamic Rate Load Ca (kgf)	2410
Static Rate Load Co (kgf)	6900
Axial Play	0
Preloading Torque (kgf-cm)	2.32~4.82

Unit:mm

Model No.	Screw Spindle (Shaft) Length				Accuracy Grade	Lead Accuracy	
	L1	L2	L3	L4		Accumulated reference lead deviation E	Lead Deriation in random 300mm e_{300}
1R32-06B2-1FOWC-380-629-0.018	380	400	629	15	5	0.025	0.018
1R32-06B2-1FOWC-580-829-0.018	580	600	829	15	5	0.030	0.018
1R32-06B2-1FOWC-780-1029-0.018	780	800	1029	15	5	0.035	0.018
1R32-06B2-1FOWC-980-1229-0.018	980	1000	1229	15	5	0.040	0.018
1R32-06B2-1FOWC-1180-1429-0.018	1180	1200	1429	15	5	0.046	0.018
1R32-06B2-1FOWC-1480-1729-0.018	1480	1500	1729	15	5	0.054	0.018

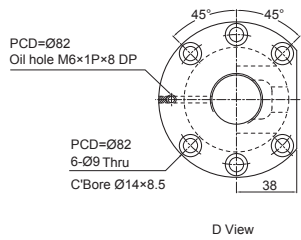
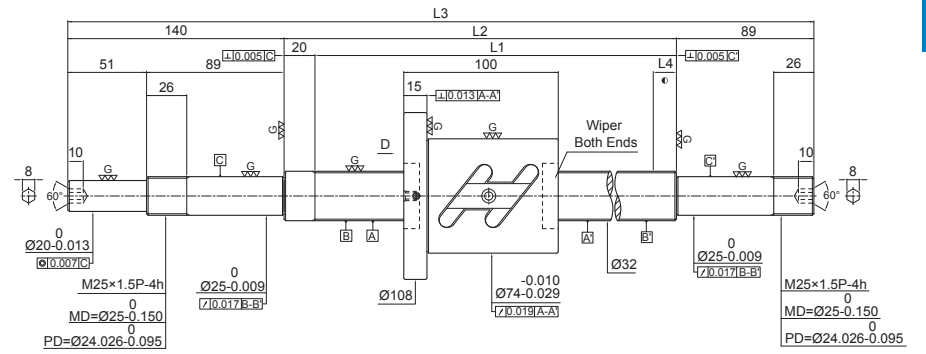
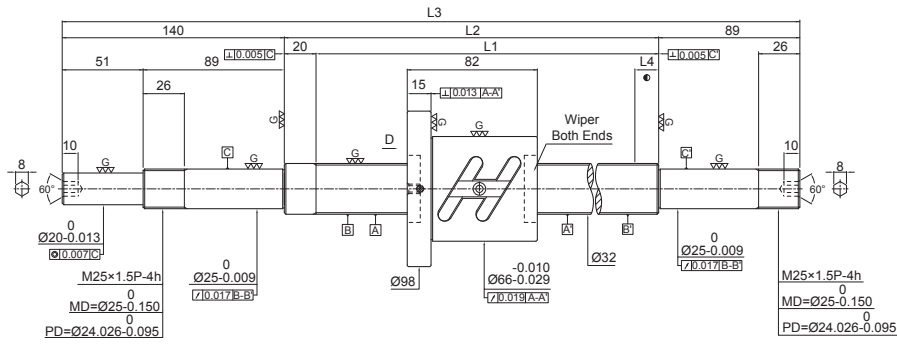

Specification of ball screw	
Production Specification	With Preload
Number of Thread / Thread Direction	1/Right
BCD	33
Lead	8
Ball Dia.	4.762
Effective Turns (Circuit × Row)	2.5 × 1(2)
Lead Angle	4.41
Dynamic Rate Load Ca (kgf)	1720
Static Rate Load Co (kgf)	4180
Axial Play	0
Preloading Torque (kgf-cm)	1.26~5.06

Unit:mm

Model No.	Screw Spindle (Shaft) Length				Accuracy Grade	Lead Accuracy	
	L1	L2	L3	L4		Accumulated reference lead deviation E	Lead Deriation in random 300mm e ₃₀₀
1R32-08B1-1FOWC-380-629-0.018	380	400	629	15	5	0.025	0.018
1R32-08B1-1FOWC-580-829-0.018	580	600	829	15	5	0.030	0.018
1R32-08B1-1FOWC-780-1029-0.018	780	800	1029	15	5	0.035	0.018
1R32-08B1-1FOWC-980-1229-0.018	980	1000	1229	15	5	0.040	0.018
1R32-08B1-1FOWC-1480-1729-0.018	1480	1500	1729	15	5	0.054	0.018

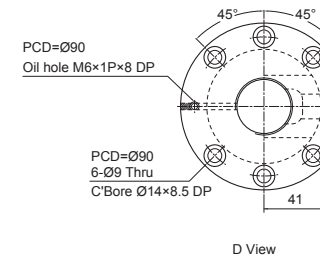

Specification of ball screw	
Production Specification	With Preload
Number of Thread / Thread Direction	1/Right
BCD	33.4
Lead	10
Ball Dia.	6.35
Effective Turns (Circuit × Row)	2.5 × 1(2)
Lead Angle	5.44
Dynamic Rate Load Ca (kgf)	2570
Static Rate Load Co (kgf)	5440
Axial Play	0
Preloading Torque (kgf-cm)	3.58~7.44

Unit:mm

Model No.	Screw Spindle (Shaft) Length				Accuracy Grade	Lead Accuracy	
	L1	L2	L3	L4		Accumulated reference lead deviation E	Lead Deriation in random 300mm e ₃₀₀
1R32-10B1-1FOWC-380-629-0.018	380	400	629	15	5	0.025	0.018
1R32-10B1-1FOWC-480-729-0.018	480	500	729	15	5	0.027	0.018
1R32-10B1-1FOWC-580-829-0.018	580	600	829	15	5	0.030	0.018
1R32-10B1-1FOWC-680-929-0.018	680	700	929	15	5	0.030	0.018
1R32-10B1-1FOWC-780-1029-0.018	780	800	1029	15	5	0.035	0.018
1R32-10B1-1FOWC-980-1229-0.018	980	1000	1229	15	5	0.040	0.018
1R32-10B1-1FOWC-1180-1429-0.018	1180	1200	1429	15	5	0.046	0.018
1R32-10B1-1FOWC-1480-1729-0.018	1480	1500	1729	15	5	0.054	0.018
1R32-10B1-1FOWC-1780-2029-0.018	1780	1800	2029	15	5	0.065	0.018

FOWC

Standard ballscrews
Screw Dia. $\varnothing 36$ Lead 10

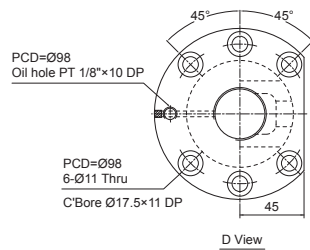
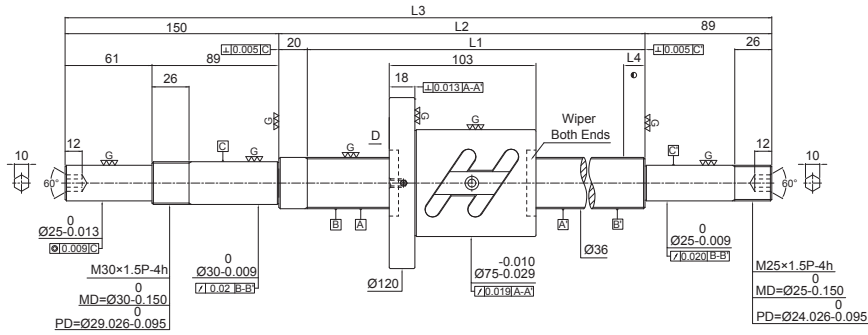

Specification of ball screw	
Production Specification	With Preload
Number of Thread / Thread Direction	1/Right
BCD	37.4
Lead	10
Ball Dia.	6.35
Effective Turns (Circuit x Row)	2.5 x 1(2)
Lead Angle	4.86
Dynamic Rate Load Ca (kgf)	2720
Static Rate Load Co (kgf)	6180
Axial Play	0
Preloading Torque (kgf-cm)	3.91~8.13

Unit:mm

Model No.	Screw Spindle (Shaft) Length				Accuracy Grade	Lead Accuracy	
	L1	L2	L3	L4		Accumulated reference lead deviation E	Lead Deriation in random 300mm e_{300}
1R36-10B1-1FOWC-480-739-0.018	480	500	739	15	5	0.027	0.018
1R36-10B1-1FOWC-680-939-0.018	680	700	939	15	5	0.030	0.018
1R36-10B1-1FOWC-980-1239-0.018	980	1000	1239	15	5	0.040	0.018
1R36-10B1-1FOWC-1380-1639-0.018	1380	1400	1639	15	5	0.054	0.018
1R36-10B1-1FOWC-1780-2039-0.018	1780	1800	2039	15	5	0.065	0.018

FOWC

Standard ballscrews
Screw Dia. $\varnothing 40$ Lead 08

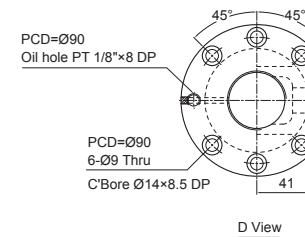
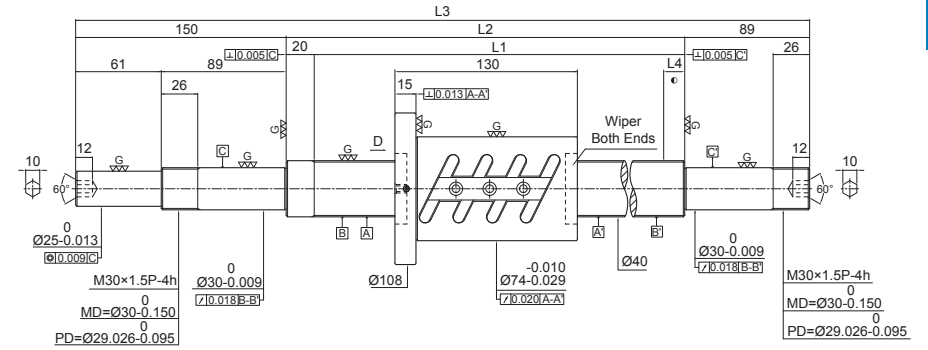

Specification of ball screw	
Production Specification	With Preload
Number of Thread / Thread Direction	1/Right
BCD	41
Lead	8
Ball Dia.	4.762
Effective Turns (Circuit x Row)	2.5 x 2(2)
Lead Angle	3.55
Dynamic Rate Load Ca (kgf)	3450
Static Rate Load Co (kgf)	10540
Axial Play	0
Preloading Torque (kgf-cm)	4.24~8.82

Unit:mm

Model No.	Screw Spindle (Shaft) Length				Accuracy Grade	Lead Accuracy	
	L1	L2	L3	L4		Accumulated reference lead deviation E	Lead Deriation in random 300mm e_{300}
1R40-08B2-1FOWC-380-639-0.018	380	400	639	15	5	0.025	0.018
1R40-08B2-1FOWC-580-839-0.018	580	600	839	15	5	0.030	0.018
1R40-08B2-1FOWC-780-1039-0.018	780	800	1039	15	5	0.035	0.018
1R40-08B2-1FOWC-980-1239-0.018	980	1000	1239	15	5	0.040	0.018
1R40-08B2-1FOWC-1180-1439-0.018	1180	1200	1439	15	5	0.046	0.018
1R40-08B2-1FOWC-1580-1839-0.018	1580	1600	1839	15	5	0.054	0.018

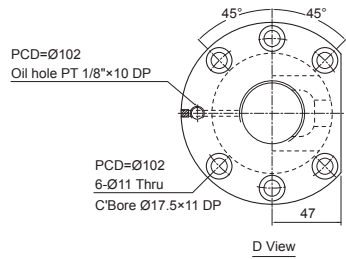
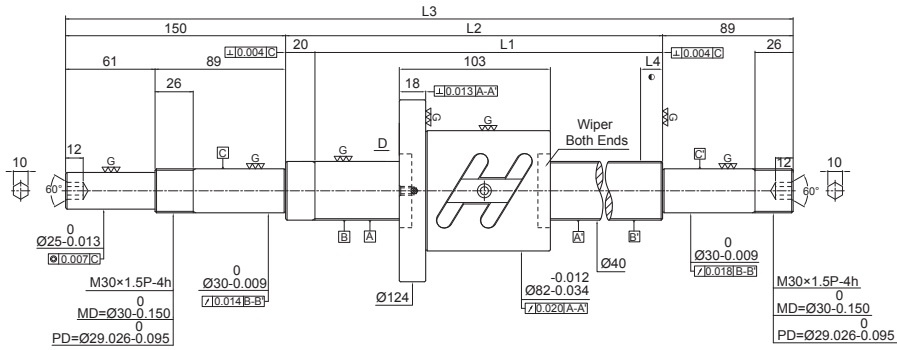

Specification of ball screw	
Production Specification	With Preload
Number of Thread / Thread Direction	1/Right
BCD	41.4
Lead	10
Ball Dia.	6.35
Effective Turns (Circuit × Row)	2.5 × 1(2)
Lead Angle	4.4
Dynamic Rate Load Ca (kgf)	2880
Static Rate Load Co (kgf)	6950
Axial Play	0
Preloading Torque (kgf-cm)	4.57~8.49

Unit: mm

Model No.	Screw Spindle (Shaft) Length				Accuracy Grade	Lead Accuracy	
	L1	L2	L3	L4		Accumulated reference lead deviation E	Lead Deriation in random 300mm e_{300}
1R40-10B1-1FOWC-480-739-0.018	480	500	739	15	5	0.027	0.018
1R40-10B1-1FOWC-580-839-0.018	580	600	839	15	5	0.030	0.018
1R40-10B1-1FOWC-680-939-0.018	680	700	939	15	5	0.030	0.018
1R40-10B1-1FOWC-780-1039-0.018	780	800	1039	15	5	0.035	0.018
1R40-10B1-1FOWC-980-1239-0.018	980	1000	1239	15	5	0.040	0.018
1R40-10B1-1FOWC-1180-1439-0.018	1180	1200	1439	15	5	0.046	0.018
1R40-10B1-1FOWC-1380-1639-0.018	1380	1400	1639	15	5	0.054	0.018
1R40-10B1-1FOWC-1580-1839-0.018	1580	1600	1839	15	5	0.054	0.018
1R40-10B1-1FOWC-1780-2039-0.018	1780	1800	2039	15	5	0.065	0.018
1R40-10B1-1FOWC-2380-2639-0.018	2380	2400	2639	15	5	0.077	0.018

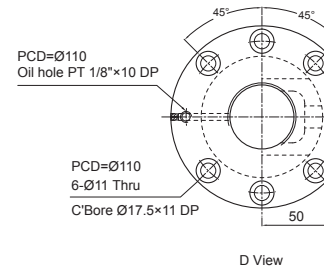
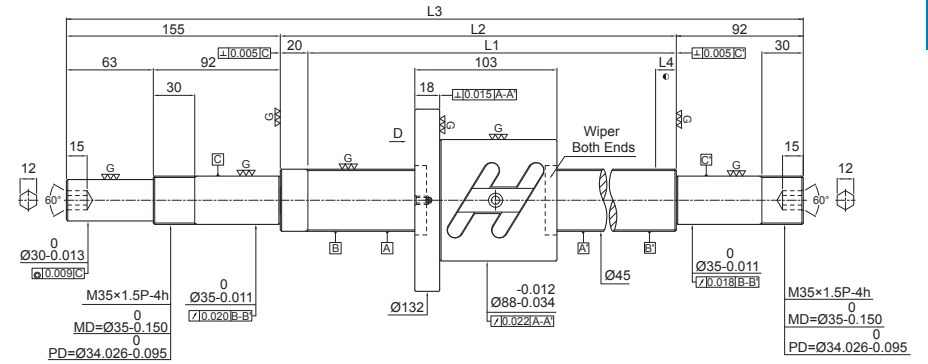

Specification of ball screw	
Production Specification	With Preload
Number of Thread / Thread Direction	1/Right
BCD	46.4
Lead	10
Ball Dia.	6.35
Effective Turns (Circuit × Row)	2.5 × 1(2)
Lead Angle	4.4
Dynamic Rate Load Ca (kgf)	3020
Static Rate Load Co (kgf)	7850
Axial Play	0
Preloading Torque (kgf-cm)	4.58~9.5

Unit: mm

Model No.	Screw Spindle (Shaft) Length				Accuracy Grade	Lead Accuracy	
	L1	L2	L3	L4		Accumulated reference lead deviation E	Lead Deriation in random 300mm e_{300}
1R45-10B1-1FOWC-680-947-0.018	680	700	947	15	5	0.035	0.018
1R45-10B1-1FOWC-980-1247-0.018	980	1000	1247	15	5	0.04	0.018
1R45-10B1-1FOWC-1380-1647-0.018	1380	1400	1647	15	5	0.054	0.018
1R45-10B1-1FOWC-1780-2047-0.018	1780	1800	2047	15	5	0.065	0.018
1R45-10B1-1FOWC-2480-2747-0.018	2480	2500	2747	15	5	0.077	0.018

FOWC

Standard ballscrews
Screw Dia. Ø50 Lead10

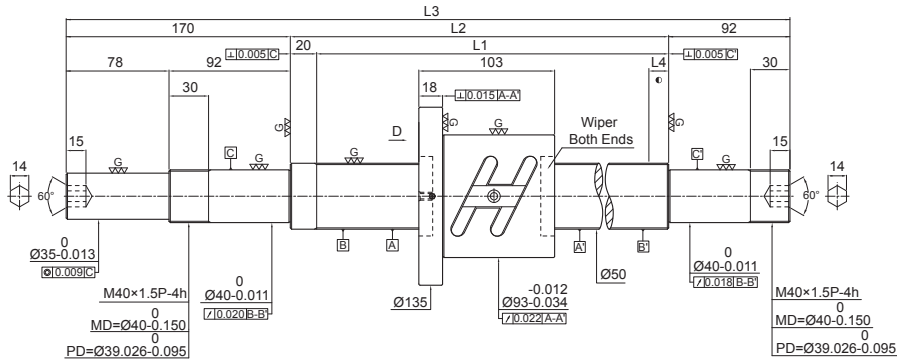

Specification of ball screw

Production Specification	With Preload
Number of Thread / Thread Direction	1/Right
BCD	51.4
Lead	10
Ball Dia.	6.35
Effective Turns (Circuit × Row)	2.5 × 1(2)
Lead Angle	3.54
Dynamic Rate Load Ca (kgf)	3190
Static Rate Load Co (kgf)	8710
Axial Play	0
Preloading Torque (kgf-cm)	4.84~11.28

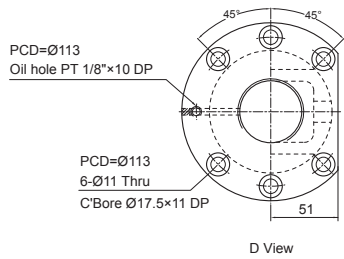

Unit:mm

Model No.	Screw Spindle (Shaft) Length				Accuracy Grade	Lead Accuracy	
	L1	L2	L3	L4		Accumulated reference lead deviation E	Lead Deriation in random 300mm e ₃₀₀
1R50-10B1-1FOWC-580-862-0.018	580	600	862	15	5	0.030	0.018
1R50-10B1-1FOWC-780-1062-0.018	780	800	1062	15	5	0.035	0.018
1R50-10B1-1FOWC-980-1262-0.018	980	1000	1262	15	5	0.040	0.018
1R50-10B1-1FOWC-1180-1462-0.018	1180	1200	1462	15	5	0.046	0.018
1R50-10B1-1FOWC-1480-1762-0.018	1480	1500	1762	15	5	0.054	0.018
1R50-10B1-1FOWC-1980-2262-0.018	1980	2000	2262	15	5	0.065	0.018
1R50-10B1-1FOWC-2580-2862-0.018	2580	2600	2862	15	5	0.093	0.018

FOWC

Standard ballscrews
Screw Dia. Ø50 Lead10

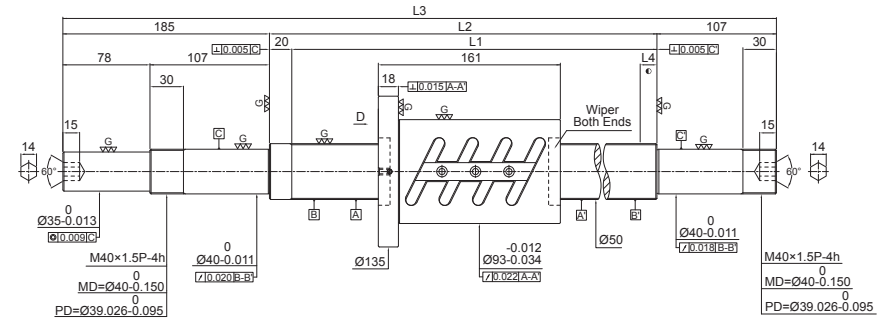

Specification of ball screw

Production Specification	With Preload
Number of Thread / Thread Direction	1/Right
BCD	51.4
Lead	10
Ball Dia.	6.35
Effective Turns (Circuit × Row)	2.5 × 2(2)
Lead Angle	3.54
Dynamic Rate Load Ca (kgf)	5790
Static Rate Load Co (kgf)	17420
Axial Play	0
Preloading Torque (kgf-cm)	10.48~17.48

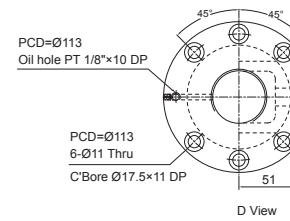

Unit:mm

Model No.	Screw Spindle (Shaft) Length				Accuracy Grade	Lead Accuracy	
	L1	L2	L3	L4		Accumulated reference lead deviation E	Lead Deriation in random 300mm e ₃₀₀
1R50-10B2-1FOWC-580-892-0.018	580	600	892	15	5	0.030	0.018
1R50-10B2-1FOWC-780-1092-0.018	780	800	1092	15	5	0.035	0.018
1R50-10B2-1FOWC-980-1292-0.018	980	1000	1292	15	5	0.040	0.018
1R50-10B2-1FOWC-1180-1492-0.018	1180	1200	1492	15	5	0.046	0.018
1R50-10B2-1FOWC-1480-1792-0.018	1480	1500	1792	15	5	0.054	0.018
1R50-10B2-1FOWC-1980-2292-0.018	1980	2000	2292	15	5	0.065	0.018
1R50-10B2-1FOWC-2580-2892-0.018	2580	2600	2892	15	5	0.093	0.018

FDWC Standard ballscrews
Screw Dia.Ø32 Lead10

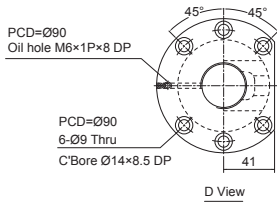
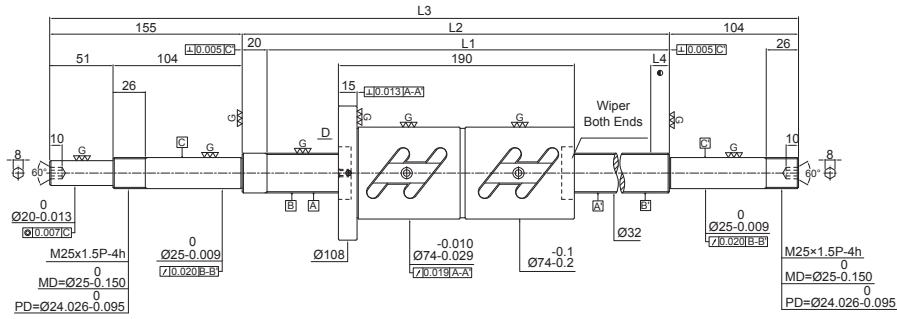

Specification of ball screw	
Production Specification	With Preload
Number of Thread / Thread Direction	1/Right
BCD	33.4
Lead	10
Ball Dia.	6.35
Effective Turns (Circuit x Row)	2.5 x 2
Lead Angle	5.44
Dynamic Rate Load Ca (kgf)	4660
Static Rate Load Co (kgf)	10880
Axial Play	0
Preloading Torque (kgf-cm)	5.51~11.43

Unit: mm

Model No.	Screw Spindle (Shaft) Length				Accuracy Grade	Lead Accuracy	
	L1	L2	L3	L4		Accumulated reference lead deviation E	Lead Deriation in random 300mm e ₃₀₀
1R32-10B2-1FDWC-380-659-0.018	380	400	659	15	5	0.025	0.018
1R32-10B2-1FDWC-480-759-0.018	480	500	759	15	5	0.027	0.018
1R32-10B2-1FDWC-580-859-0.018	580	600	859	15	5	0.030	0.018
1R32-10B2-1FDWC-680-959-0.018	680	700	959	15	5	0.030	0.018
1R32-10B2-1FDWC-780-1059-0.018	780	800	1059	15	5	0.035	0.018
1R32-10B2-1FDWC-980-1259-0.018	980	1000	1259	15	5	0.040	0.018
1R32-10B2-1FDWC-1180-1459-0.018	1180	1200	1459	15	5	0.046	0.018
1R32-10B2-1FDWC-1480-1759-0.018	1480	1500	1759	15	5	0.054	0.018
1R32-10B2-1FDWC-1780-2059-0.018	1780	1800	2059	15	5	0.065	0.018

Standard ballscrews **FDWC**
Screw Dia.Ø36 Lead10

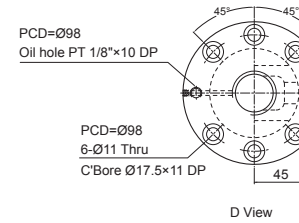
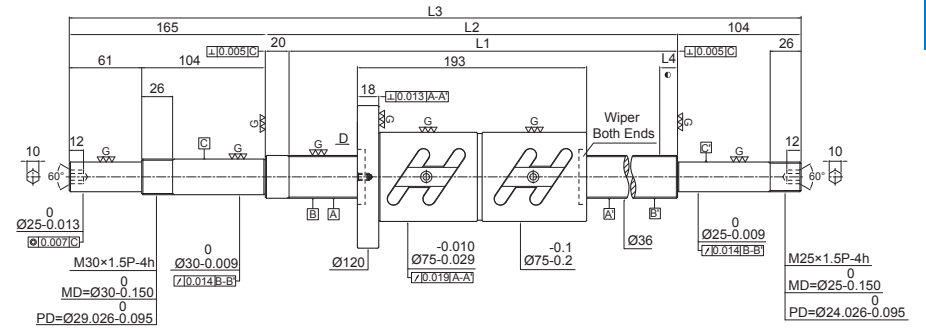

Specification of ball screw	
Production Specification	With Preload
Number of Thread / Thread Direction	1/Right
BCD	37.4
Lead	10
Ball Dia.	6.35
Effective Turns (Circuit x Row)	2.5 x 2
Lead Angle	4.86
Dynamic Rate Load Ca (kgf)	4930
Static Rate Load Co (kgf)	12360
Axial Play	0
Preloading Torque (kgf-cm)	6.64~12.34

Unit: mm

Model No.	Screw Spindle (Shaft) Length				Accuracy Grade	Lead Accuracy	
	L1	L2	L3	L4		Accumulated reference lead deviation E	Lead Deriation in random 300mm e ₃₀₀
1R36-10B2-1FDWC-480-769-0.018	480	500	769	15	5	0.027	0.018
1R36-10B2-1FDWC-680-969-0.018	680	700	969	15	5	0.035	0.018
1R36-10B2-1FDWC-980-1269-0.018	980	1000	1269	15	5	0.040	0.018
1R36-10B2-1FDWC-1380-1669-0.018	1380	1400	1669	15	5	0.054	0.018
1R36-10B2-1FDWC-1780-2069-0.018	1780	1800	2069	15	5	0.065	0.018

FDWC Standard ballscrews
Screw Dia. $\varnothing 40$ Lead 10

Standard ballscrews **FDWC**
Screw Dia. $\varnothing 40$ Lead 12

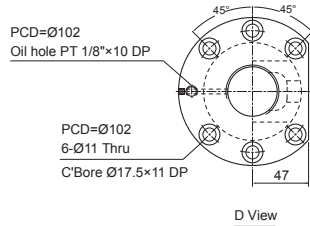
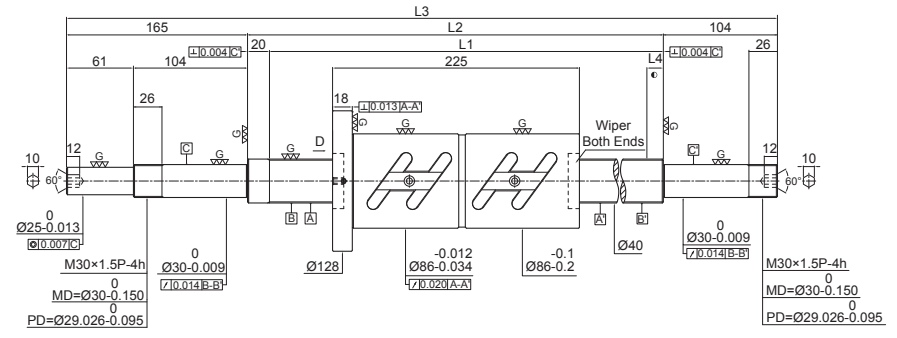
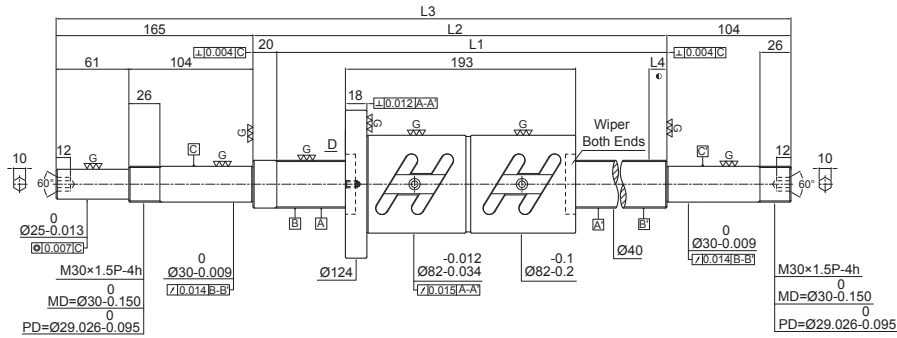

Specification of ball screw	
Production Specification	With Preload
Number of Thread / Thread Direction	1/Right
BCD	41.4
Lead	10
Ball Dia.	6.35
Effective Turns (Circuit x Row)	2.5 x 2
Lead Angle	4.4
Dynamic Rate Load Ca (kgf)	5220
Static Rate Load Co (kgf)	13900
Axial Play	0
Preloading Torque (kgf-cm)	8.26~13.78

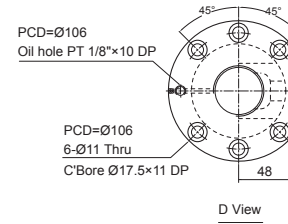

Specification of ball screw	
Production Specification	With Preload
Number of Thread / Thread Direction	1/Right
BCD	41.5
Lead	12
Ball Dia.	7.144
Effective Turns (Circuit x Row)	2.5 x 2
Lead Angle	5.26
Dynamic Rate Load Ca (kgf)	6170
Static Rate Load Co (kgf)	15700
Axial Play	0
Preloading Torque (kgf-cm)	9.79~18.17

Unit: mm

Unit: mm

Model No.	Screw Spindle (Shaft) Length				Accuracy Grade	Lead Accuracy	
	L1	L2	L3	L4		Accumulated reference lead deviation E	Lead Deriation in random 300mm e ₃₀₀
1R40-10B2-1FDWC-480-769-0.018	480	500	769	15	5	0.027	0.018
1R40-10B2-1FDWC-580-869-0.018	580	600	869	15	5	0.030	0.018
1R40-10B2-1FDWC-680-969-0.018	680	700	969	15	5	0.030	0.018
1R40-10B2-1FDWC-780-1069-0.018	780	800	1069	15	5	0.035	0.018
1R40-10B2-1FDWC-980-1269-0.018	980	1000	1269	15	5	0.040	0.018
1R40-10B2-1FDWC-1180-1469-0.018	1180	1200	1469	15	5	0.046	0.018
1R40-10B2-1FDWC-1380-1669-0.018	1380	1400	1669	15	5	0.054	0.018
1R40-10B2-1FDWC-1580-1869-0.018	1580	1600	1869	15	5	0.054	0.018
1R40-10B2-1FDWC-1780-2069-0.018	1780	1800	2069	15	5	0.065	0.018
1R40-10B2-1FDWC-2380-2269-0.018	2380	2400	2269	15	5	0.077	0.018

Model No.	Screw Spindle (Shaft) Length				Accuracy Grade	Lead Accuracy	
	L1	L2	L3	L4		Accumulated reference lead deviation E	Lead Deriation in random 300mm e ₃₀₀
1R40-12B2-1FDWC-680-969-0.018	680	700	969	15	5	0.030	0.018
1R40-12B2-1FDWC-980-1269-0.018	980	1000	1269	15	5	0.040	0.018
1R40-12B2-1FDWC-1380-1669-0.018	1380	1400	1669	15	5	0.054	0.018
1R40-12B2-1FDWC-1780-2069-0.018	1780	1800	2069	15	5	0.065	0.018
1R40-12B2-1FDWC-2480-2769-0.018	2480	2500	2769	15	5	0.077	0.018

Introduction to Rolled Ballscrews

The production of the *PMI* rolled ballscrews has adopted a manufacturing process and equipment unlike other manufacturers. Combining advanced skills and the Bad Düben digital electric screw thread rolling machine, we adhere to a strict quality control policy at every stage of production, from the selection of ballscrew material and rolled processing to induction hardening heat treatment and post production. We are committed to providing clients with products of the best quality.

The combination of rolled ballscrews and ground nuts has replaced the traditional ACME screws and trapezoidal screws. This makes for a smoother operation while lowering friction and backlash. Moreover, the new technology has the advantage of faster production speed and lower prices.

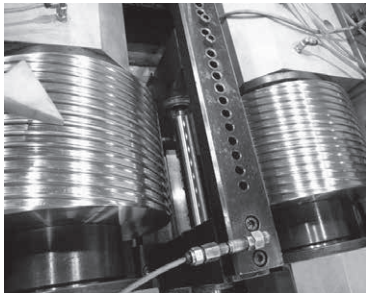

We employ the most advanced digital electric screw thread rolling machine. During the manufacturing process, the oil cylinders on the two axes of the thread rolling dies employ a servo hydraulic system for the correction of oil pressure and positioning precision.



We employ Germany-imported Bad Düben roller in order to maintain the stability of the thread rolling machine and the quality of the rolled product.

Features of the *PMI* Rolled Ballscrew

High Precision Rolled Nuts

The manufacturing process of rolled nuts is identical to that of ground nuts. Surface hardening treatment and internal thread grinding ensure durability and smoothness.

Nuts are Interchangeable

Without preload and within the maximum permissible axial play, different types of nuts can be used on the same screw.

Lead Accuracy of Rolled Screws (e_{300})

According to ISO 3408-3, the definition of lead accuracy for *PMI* rolled ballscrews is as follows: Within the effective thread length, the permissible value of accumulated lead deviation in random 300mm. As shown in **Table 1**:

Table 1 Lead Accuracy

e_{300} (Within the effective thread length, the permissible value of accumulated lead deviation in random 300mm)

Unit: μm

Grade	C5	C7	C8	C10
ISO, DIN	23	52	-	210
JIS	18	50	-	210
<i>PMI</i>	23	50	100	210

e_p (Within the effective thread length, the permissible value of accumulated lead deviation)

Unit: μm

Grade	C5	C7	C8	C10
<i>PMI</i>	$e_p = \pm(lu/300) \times e_{300}$ lu: Effective thread length (Unit: mm)			

Unit: μm

e_{300} / Grade	C5	C7	C8	C10
Measured length				
0~100	20	44	84	178
101~200	22	48	92	194
201~315	25	50	100	210

Reference Table of the Nominal Outer Diameter and Lead of the PMI's Rolled Screw Shaft

PMI rolled ballscrews offer a variety of specifications, lead accuracies, and maximum rolling length, as shown in Table 2~3:

Table 2 Specifications of Rolled Ballscrews

Screw nominal outer diameter \varnothing	Lead															Maximum rolled ballscrew length
	1	2	2.5	4	5	5.08	6	10	12	16	20	25	32	40	50	
8	●	●	●													1000
10		●						●								1000
12				●	●			●	●							1500
14				●	●											3000
15					●			●		●	●					3000
16				●	●			●		●						3000
20				●	●			●			●			●		3000
25				●	●/○	●/○		●				●				6000
28					●		●									6000
32				●/○	●/○			●			●		●/○			6000
36								●								6000
38								●			●			●		6000
40				●				●			●			●		6000
50								●			●				●	6000
63								●			●					6000
80								●								6000

● : right-hand thread ○ : left-hand thread

Note: Rolled ballscrews are limited in length and accuracy, please contact us for other requirements.

Table 3 Lead Accuracy and Maximum Rolled Length

Screw nominal outer diameter $\varnothing(mm)$	Lead Accuracy Grade (e_{300}) Maximum Rolling Length (mm)			
	C5	C7	C8	C10
8	-	1000	1000	1000
10	-	1000	1000	1000
12	1500	1500	1500	1500
14	3000	3000	3000	3000
15				
16				
20				
25				
28				
32				
36	6000	6000	6000	
38	6000	6000	6000	
40				
50				
63	-	6000	6000	6000
80	-	6000	6000	6000

Axial Play

The maximum axial play under normal non-preload condition, as shown in **Table 4**

Table 4 Maximum Axial Play

Ball Diameter $\varnothing d$ (mm)	0.8~1.2	1.588~2.381	2.778~4.762	6.35~7.938
Maximum Axial Play (mm)	<0.01	<0.02	<0.04	<0.07

Materials and Hardness

Standard material and surface hardness for *PMI* rolled screw, as shown in **Table 5**

Table 5

Denomination	Material	Heat Treatment	Hardness (HRC)
Rolled screw	S55C/Equivalent	Induction hardening	58~62
Nuts	SCM420H/Equivalent	Carburized hardening	58~62

Types and Dimensions of Rolled Screw Shaft

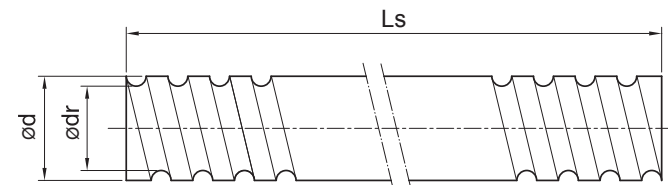

Unit: mm

O.D.	SCREW SIZE		Lead Accuracy Grade	Thread Direction	Number of Threads	Maximum Rolling Length	Screw Number		
	LEAD	BALL DIA.		L: Left / R: Right					
8	1	0.8	C7,C8,C10	R	1	1000	R0801X		
	2	1.2					R0802Y		
	2.5	2					R0812Z		
10	2	1.588	C7,C8,C10	R	1	1000	R1002K		
	10	2.381			2		2R1010A		
12	4	2.381	C5,C7,C8,C10	R	1	3000	R1204A		
	5	2					R1205Z		
	10	2					2R1010Z		
	12	2.381			R		2	2R1010A	
							20	2.381	4
14	4	2.381	C5,C7,C8,C10	R	1	3000	4R1220A		
	5	3.175					R1404A		
15	5	2.778	C5,C7,C8,C10	R	1	3000	R1405B		
		3					R1505L		
		2.778					R1505V		
	10	3			C5,C7,C8,C10		R	2	2R1510L
		3.175							2R1510V
		2.778							2R1510B
	16	3			C7,C8,C10		R	4	4R1516L
		3						2	2R1516V
	20	2.778			C7,C8,C10		R	4	4R1520L
3.175		4R1520B							
3		2	C5,C7,C8,C10	R		1			3000
									4
5	2.381	C5,C7,C8,C10	R	1	R1604A				
10	3.175				R1605B				
16	3.175				C5,C7,C8,C10	R	2	2R1610B	
								2R1616B	

Unit: mm

SCREW SIZE			Lead Accuracy Grade	Thread Direction L: Left / R: Right	Number of Threads	Maximum Rolling Length	Screw Number	
O.D.	LEAD	BALL DIA.						
20	4	2.381	C5,C7,C8,C10	R	1	3000	R2004A	
	5	3.175					R2005B	
	10	3.175					2R2010B	
	10	4.762					R2010D	
	20	3.175	C5,C7,C8,C10	R	4	3000	4R2020B	
40	3.175	C7,C8,C10	R	8	3000	8R2020B		
25	4	2.381	C5,C7,C8,C10	R	1	6000	R2504A	
	5	3.175		R/L			R(L)2505B	
	5.08	3.175		R/L			R(L)2515B	
	10	3.175		R			2	2R2510B
	10	4.762					1	R2510D
	10	6.35					1	R2510F
	25	3.175					4	4R2525B
	25	3.969		4			4R2525C	
50	3.969	8	8R2550C					
28	5	3.175	C5,C7,C8,C10	R	1	6000	R2805B	
	6						R2806B	
32	5	3.175	C5,C7,C8,C10	R/L	1	6000	R(L)3205B	
	5.08						R(L)3215B	
	10	3.969		R			1	R3210C
	10	6.35					1	R3210F
	20	3.969					2	2R3220C
	20	6.35					2	2R3220F
32	3.969	R/L	4	4R3232C				
32	4.762		4	4R(L)3232D				
36	10	6.35	C5,C7,C8,C10	R	1	6000	R3610F	
38	10	6.35	C5,C7,C8,C10	R	1	6000	R3810F	
	20				2	2R3820F		
	40				4	4R3840F		
40	5	3.175	C5,C7,C8,C10	R	1	6000	R4005B	
	10	6.35			1	R4010F		
	20				2	2R4020F		
	40				4	4R4040F		
50	10	6.35	C5,C7,C8,C10	R	1	6000	R5010F	
	20				2	2R5020F		
	50				4	4R5050H		
63	10	6.35	C7,C8,C10	R	1	6000	R6310F	
	20				2	2R6320F		
80	10	6.35	C7,C8,C10	R	1	6000	R8010F	

Nomenclature

1 R 15 10 A -1500 -C7

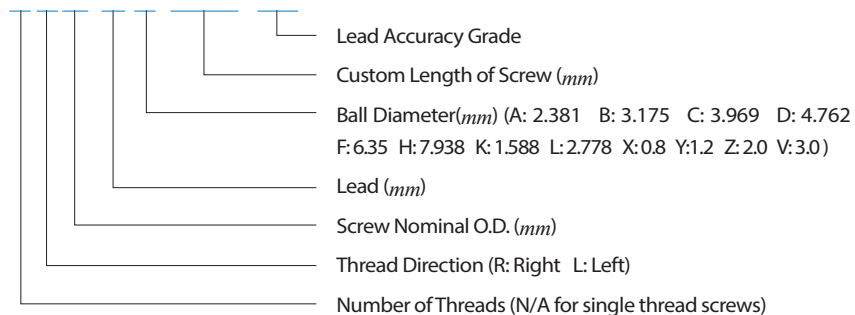

Nut Types of Rolled Ballscrew

Standard Models:

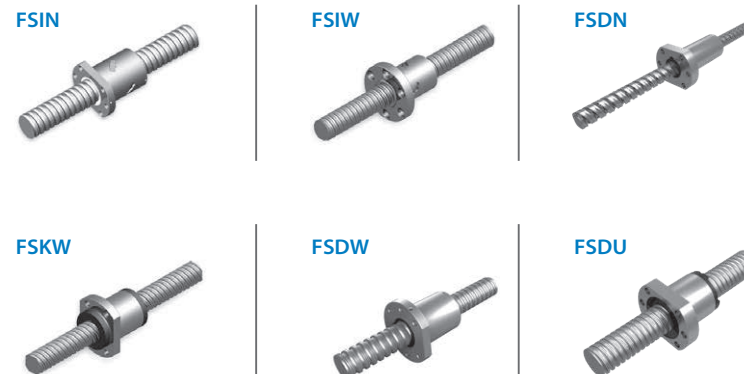

Optional Models:

FSWW



FSVW



RSVW



SSVW



FSBW



FSMW



Nomenclature:

R F SDN 25 05 A 4T

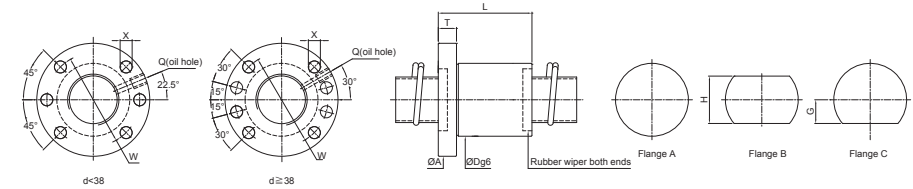
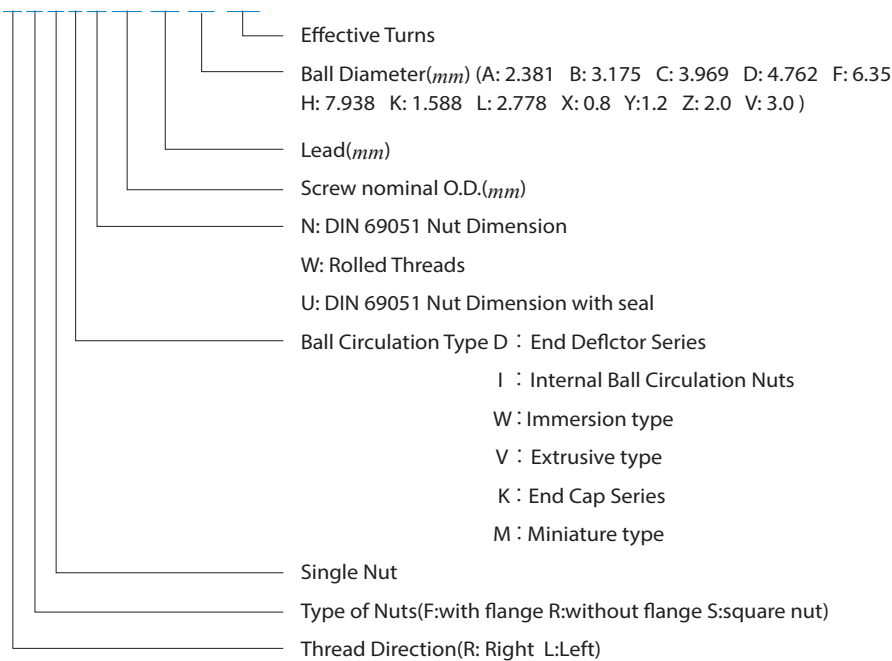

Unit:mm

SCREW SIZE		BALL DIA.	circuit × number of thread	MODIFIED LOAD CAPACITY (kgf)		BALLNUT DIMENSION										Nut Model NO.
O.D.	LEAD			Dynamic (1×10 ⁴ REV) Cam	Static Coam	O.D.	Length	Flange					Oil Hole	Assembly Hole	STIFFNESS	
						D	L	A	T	W	G	H	Q	X	kgf/μm	
15	5	3	4×1	1210	2130	28	39	48	10	38	20	40	M6×1P	5.5	22	FSDN1505V-4.0P
	10		3×1	950	1650	28	47	48	10	38	20	40	M6×1P	5.5	17	FSDN1510V-3.0P
	16		3×1	910	1600	28	64	48	10	38	20	40	M6×1P	5.5	17	FSDN1516V-3.0P
20	5	3.175	4×1	1570	3270	36	40	58	10	47	22	44	M6×1P	6.6	28	FSDN2005B-4.0P
	20		2×2	1460	3120	36	58	58	10	47	22	44	M6×1P	6.6	28	FSDN2020B-4.0P
25	5	3.175	5×1	2130	5230	40	46	62	10	51	24	48	M6×1P	6.6	41	FSDN2505B-5.0P
	10		4×1	1740	4120	40	60	62	10	51	24	48	M6×1P	6.6	33	FSDN2510B-4.0P
	25		2×2	1610	3900	40	68	62	10	51	24	48	M6×1P	6.6	33	FSDN2525B-4.0P
32	5	3.175	6×1	2800	8180	50	53	80	12	65	31	62	M6×1P	9	59	FSDN3205B-6.0P
	10		5×1	3240	8480	50	73	80	12	65	31	62	M6×1P	9	52	FSDN3210C-5.0P
	20		3.969	4×1	2600	6630	50	101	80	12	65	31	62	M6×1P	9	42
38	32	6.35	2×2	2460	6340	50	84	80	12	65	31	62	M6×1P	9	41	FSDN3232C-4.0P
	10		5×1	6500	15610	63	78	93	14	78	35	70	M8×1P	9	64	FSDN3810F-5.0P
	20		4×1	5250	12240	63	107	93	14	78	35	70	M8×1P	9	52	FSDN3820F-4.0P
40	2×2	4940	11770	63	104	93	14	78	35	70	M8×1P	9	51	FSDN3840F-4.0P		

- Note:1. Cam and Coam represent the enhanced dynamic- and static load. Their calculations referred to the standard of DIN 69051.
2. Stiffness of nut: Stiffness values listed above are derived from theoretical formula to the elastic deformation between thread grooves and balls while axial load is 30% dynamic load rating.

FSDU

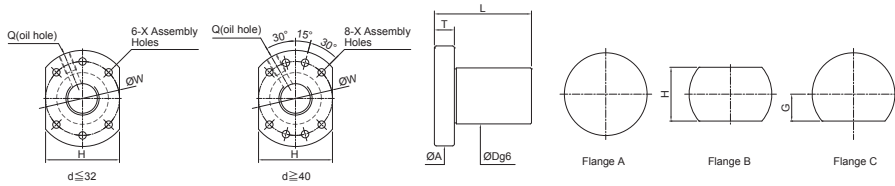

Unit: mm

SCREW SIZE		BALL DIA.	EFFECTIVE TURNS circuit × number of thread	MODIFIED LOAD CAPACITY (kgf)		BALLNUT DIMENSION										Nut Model NO.
O.D.	LEAD			Dynamic (1×10 ⁶ REV.) Cam	Static Coam	O.D.	Length	Flange					Oil Hole	Assembly Hole		
								D	L	A	T	W			G	
12	5	2	3x1	630	1060	24	30	40	10	32	15	30	M5×0.8P	4.5	FSDU1205Z-3.0P	
	10		3x1	620	1040	24	45	40	10	32	15	30	M5×0.8P	4.5	FSDU1210Z-3.0P	
15	5	2.778	4x1	1130	2100	28	37	48	10	38	20	40	M6×1P	5.5	FSDU1505L-4P	
	10		3x1	850	1530	28	47	48	10	38	20	40	M6×1P	5.5	FSDU1510L-3P	
	16		2x1	580	1010	28	47	48	10	38	20	40	M6×1P	5.5	FSDU1516L-2P	
	16		3x1	850	1570	28	63	48	10	38	20	40	M6×1P	5.5	FSDU1516L-3P	
20	5	3.175	4x1	1570	3270	38	40	58	10	47	22	44	M6×1P	6.6	FSDU2005B-4.0P	
	10		4x1	1560	3250	56	58	58	10	47	22	44	M6×1P	6.6	FSDU2010B-4.0P	
	20		2x1	810	1550	56	58	58	10	47	22	44	M6×1P	6.6	FSDU2020B-2.0P	
	20		3x1	1180	2430	76	78	58	10	47	22	44	M6×1P	6.6	FSDU2020B-3.0P	
25	5	3.175	4x1	1750	4150	40	39	62	10	51	24	48	M6×1P	6.6	FSDU2505B-4.0P	
	10		4x1	1740	4120	40	59	62	12	51	24	48	M6×1P	6.6	FSDU2510B-4.0P	
	20		2x1	910	1990	40	59	62	12	51	24	48	M6×1P	6.6	FSDU2520B-2.0P	
	25		2x1	900	1950	40	66	62	12	51	24	48	M6×1P	6.6	FSDU2525B-2.0P	
25	25	3.175	3x1	1290	3040	40	91	62	12	51	24	48	M6×1P	6.6	FSDU2525B-3.0P	

Note:1. Cam and Coam represent the enhanced dynamic- and static load. Their calculations referred to the standard of DIN 69051.

2. Stiffness of nut: Stiffness values listed above are derived from theoretical formula to the elastic deformation between thread grooves and balls while axial load is 30% dynamic load rating.

FSDU

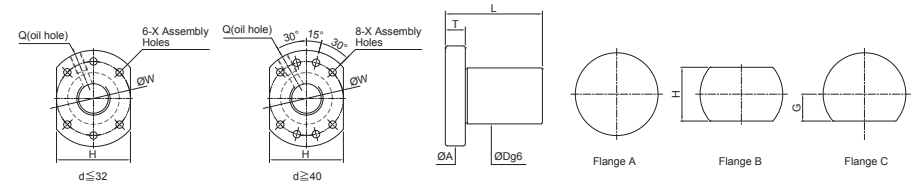

Unit: mm

SCREW SIZE		BALL DIA.	EFFECTIVE TURNS circuit × number of thread	MODIFIED LOAD CAPACITY (kgf)		BALLNUT DIMENSION										Nut Model NO.
O.D.	LEAD			Dynamic (1×10 ⁶ REV.) Cam	Static Coam	O.D.	Length	Flange					Oil Hole	Assembly Hole		
								D	L	A	T	W			G	
32	5	3.969	4x1	1940	5360	50	42	80	12	65	31	62	M6×1P	9	FSDU3205B-4.0P	
	10		4x1	2660	6710	50	62	80	12	65	31	62	M6×1P	9	FSDU3210C-4.0P	
	20		3x1	2000	4870	50	81	80	12	65	31	62	M6×1P	9	FSDU3220C-3.0P	
	32		2x1	1350	3170	50	83	80	12	65	31	62	M6×1P	9	FSDU3232C-2.0P	
38	32	6.35	3x1	1980	4920	50	115	80	12	65	31	62	M6×1P	9	FSDU3232C-3.0P	
	10		4x1	5110	13800	63	66	93	14	78	35	70	M8×1P	9	FSDU3810F-4.0P	
	20		3x1	4030	9020	63	86	93	14	78	35	70	M8×1P	9	FSDU3820F-3.0P	
40	40	6.35	2x1	2730	5890	63	103	93	14	78	35	70	M8×1P	9	FSDU3840F-2.0P	
	40		3x1	3980	7160	63	143	93	14	78	35	70	M8×1P	9	FSDU3840F-3.0P	
50	5	3.175	4x1	2130	6750	63	43	93	15	78	35	70	M8×1P	9	FSDU4005B-4.0P	
	10		6.35	4x1	6070	16540	75	70	110	15	93	55	85	M8×1P	11	FSDU5010F-4P
	20			4x1	6020	16440	75	110	110	15	93	55	85	M8×1P	11	FSDU5020F-4P

Note:1. Cam and Coam represent the enhanced dynamic- and static load. Their calculations referred to the standard of DIN 69051.

2. Stiffness of nut: Stiffness values listed above are derived from theoretical formula to the elastic deformation between thread grooves and balls while axial load is 30% dynamic load rating.

FSIN

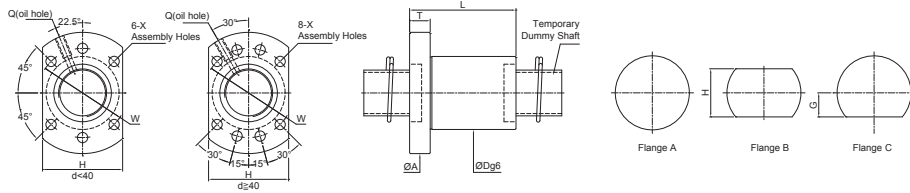

Unit: mm

SCREW SIZE		BALL DIA.	EFFECTIVE TURNS	MODIFIED LOAD CAPACITY (kgf)		BALLNUT DIMENSION										
O.D.	LEAD			Dynamic (1×10 ⁶ REV) Cam	Static Coam	O.D.		Flange					Oil Hole	Assembly Hole	STIFFNESS kgf/μm	Nut Model NO.
						D	L	A	T	W	G	H	Q	X		
16	5	3.175	3	1050	2200	28	42	48	10	38	20	40	M6×1P	5.5	17	FSIN1605B-3.0P
	20	5	3.175	4	1530	3720	36	50	58	12	47	22	44	M6×1P	6.5	25
25	5	3.175	4	1700	4720	40	50	62	12	51	24	48	M6×1P	6.5	37	FSIN2505B-4.0P
	10	4.762	4	2900	6990		85	62	12	51	24	48	M6×1P	6.5	32	FSIN2510D-4.0P
32	5	3.175	4	1900	6090	50	50	80	12	65	31	62	M6×1P	9	50	FSIN3205B-4.0P
	10	6.35	4	4720	11670	50	80	80	13	65	31	62	M6×1P	9	50	FSIN3210F-4.0P
40	5	3.175	4	2090	7670	63	54	93	15	78	35	70	M8×1P	9	52	FSIN4005B-4.0P
	10	6.35	4	5310	14850		82	93	15	78	35	70	M8×1P	9	60	FSIN4010F-4.0P
50	10	6.35	4	5890	18780	75	88	110	18	93	42.5	85	M8×1P	11	70	FSIN5010F-4.0P

Note: 1. Cam and Coam represent the enhanced dynamic- and static load. Their calculations referred to the standard of DIN 69051.

2. Stiffness of nut: Stiffness values listed above are derived from theoretical formula to the elastic deformation between thread grooves and balls while axial load is 30% dynamic load rating.

PMI Rolled BallScrews

External Ball Circulation Series

FSWW

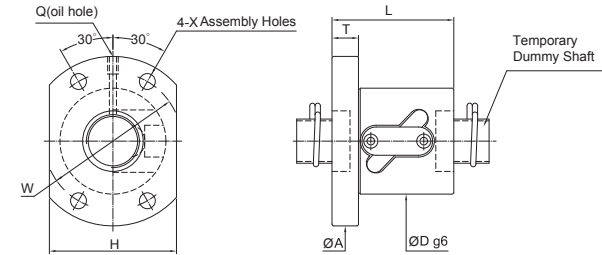

Unit: mm

SCREW SIZE		BALL DIA.	EFFECTIVE TURNS circuit × row	BASIC RATE LOAD (kgf)		BALLNUT DIMENSION										
O.D.	LEAD			Dynamic (1×10 ⁶ REV) Ca	Static Co	O.D.		Flange					Assembly Hole	Oil Hole	STIFFNESS kgf/μm	Nut Model NO.
						D	L	A	T	W	H	X	Q			
12	4	2.381	2.5x1	285	533	30	40	52	10	40	31	4.5	M6x1P	9	FSWW1204A-2.5P	
	5	2	2.5x1	270	350	26	40	47	10	37	30	4.5	M6x1P	8.2	FSWW1205Z-2.5P	
14	4	2.381	3.5x1	500	1100	35	42	57	10	45	40	4.5	M6x1P	15	FSWW1404A-3.5P	
	5	3.175	2.5x1	515	990	40	40	57	10	45	40	4.5	M6x1P	11	FSWW1405B-2.5P	
15	10	3.175	2.5x1	440	680	34	55	57	10	45	34	5.5	M6x1P	12	FSWW1510B-2.5P	
	4	2.381	3.5x1	610	1470	34	42	57	11	45	34	5.5	M6x1P	17	FSWW1604A-3.5P	
16	5	3.175	2.5x1	550	1140	40	41	63	11	51	42	5.5	M6x1P	13	FSWW1605B-2.5P	
	10	3.175	2.5x1	550	990	40	56	63	11	51	42	5.5	M6x1P	13	FSWW1610B-2.5P	
20	4	2.381	2.5x2	1140	3120	40	56	67	11	55	52	5.5	M6x1P	30	FSWW2004A-5.0P	
	5	3.175	2.5x1	625	1450	44	41	67	10	55	52	5.5	M6x1P	15	FSWW2005B-2.5P	
25	10	4.762	2.5x1	1100	2200	52	61	82	12	67	64	6.6	M6x1P	16	FSWW2010D-2.5P	
	5	3.175	2.5x2	1120	3710	50	56	73	11	61	56	6.6	M6x1P	37	FSWW2505B-5.0P	
25	10	4.762	2.5x1	1270	2780	58	65	85	15	71	64	6.6	M6x1P	20	FSWW2510D-2.5P	
	10	6.35	2.5x2	3200	7170	60	97	96	15	78	72	9	M6x1P	40	FSWW2510F-5.0P	

Note: Stiffness of nut: Stiffness values listed above are derived from theoretical formula to the elastic deformation between thread grooves and balls while axial load is 30% dynamic load rating.

FSWW

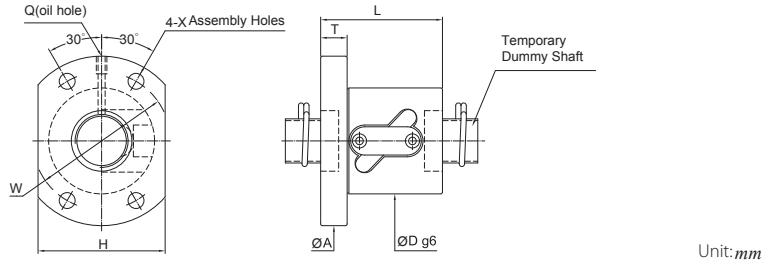

SCREW SIZE		BALL DIA.	EFFECTIVE TURNS circuit × row	BASIC RATE LOAD (kgf)		BALLNUT DIMENSION											Nut Model NO.
O.D.	LEAD			Dynamic (1×10 ⁶ REV.) Ca	Static Co	O.D.		Length		Flange			Assembly Hole	Oil Hole	STIFFNESS		
						D	L	A	T	W	H	X	Q	kgf/4m			
28	5	3.175	1.5x2	910	2470	46										21	FSWW2805B-3.0P
			2.5x1	780	2060	42										18	FSWW2805B-2.5P
			2.5x2	1410	4120	55	56	83	12	69	62	6.6	M8x1P			33	FSWW2805B-5.0P
			3.5x1	1040	2880	47										24	FSWW2805B-3.5P
32	5	3.175	2.5x2	1540	4720	58	57	85	12	71	64	6.6	M8x1P	41	FSWW3205B-5.0P		
	10	6.35	2.5x2	3130	9410	67	97	103	15	85	78	9	M6x1P	49	FSWW3210F-5.0P		
36	10	6.35	1.5x2	2170	6480	81									30	FSWW3610F-3.0P	
			2.5x2	3370	10800	70	99	110	17	90	82	11	M6x1P	29	FSWW3610F-5.0P		
			3.5x1	2480	7560	81									35	FSWW3610F-3.5P	
40	5	3.175	2.5x2	1830	5940	67	60	101	15	83	78	9	M8x1P	60	FSWW4005B-5.0P		
	10	6.35	2.5x2	3520	12000	76	100	116	17	96	88	11	M6x1P	59	FSWW4010F-5.0P		
50	10	6.35	2.5x2	3900	15000	88	101	128	18	108	100	11	M6x1P	72	FSWW5010F-5.0P		
63	10	6.35	2.5x2	4770	18660	108	105	154	22	130	116	14	M8x1P	75	FSWW6310F-5.0P		
80	10	6.35	2.5x2	5340	23750	130	105	176	22	152	132	14	M8x1P	90	FSWW8010F-5.0P		

Note: Stiffness of nut: Stiffness values listed above are derived from theoretical formula to the elastic deformation between thread grooves and balls while axial load is 30% dynamic load rating.

FSWW

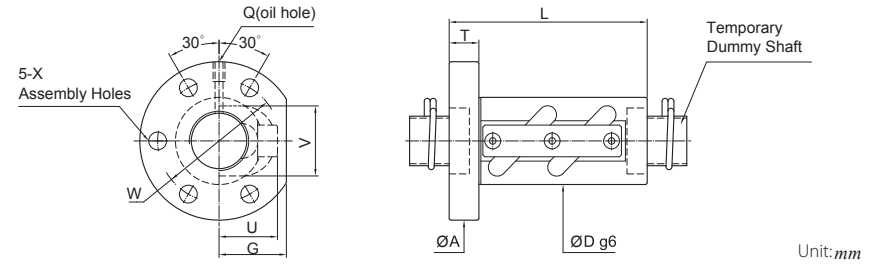

SCREW SIZE		BALL DIA.	EFFECTIVE TURNS circuit × row	BASIC RATE LOAD (kgf)		BALLNUT DIMENSION											Nut Model NO.
O.D.	LEAD			Dynamic (1×10 ⁶ REV.) Ca	Static Co	O.D.		Length		Flange			Return tube	Assembly Hole	Oil Hole	STIFFNESS	
						D	L	A	T	W	G	U	V	X	Q	kgf/4m	
14	4	2.381	3.5x1	500	1100	25	42	55	10	40	19	19	21	4.5	M6x1P	15	FSVW1404A-3.5P
	5	3.175	2.5x1	515	990	30	43	50	10	40	22	19	21	4.5	M6x1P	11	FSVW1405B-2.5P
16	5	3.175	2.5x2	1000	2280	31	60	54	12	41	24	20	23	5.5	M6x1P	23	FSVW1605B-5.0P
20	5	3.175	2.5x2	1130	2900	40	60	60	12	50	28	23	27	4.5	M6x1P	28	FSVW2005B-5.0P
	10	4.762	2.5x1	1100	2200	40	60	67	12	53	30	27	30	6.6	M6x1P	16	FSVW2010D-2.5P
25	5	3.175	2.5x1	720	1830	42	45	71	12	57	28	25	32	6.6	M6x1P	18	FSVW2505B-2.5P
	10	4.762	3.5x1	1690	3900	45	75	72	16	58	34	29	34	6.6	M6x1P	27	FSVW2510D-3.5P
28	5	3.175	1.5x2	910	2470	50										21	FSVW2805B-3.0P
			2.5x1	780	2060	45										18	FSVW2805B-2.5P
			2.5x2	1410	4120	44	60	70	12	56	28	28	35	6.6	M6x1P	33	FSVW2805B-5.0P
			3.5x1	1040	2880	50										24	FSVW2805B-3.5P
32	5	3.175	2.5x2	1540	4720	50	60	76	12	63	36	30	39	6.6	M6x1P	41	FSVW3205B-5.0P
	10	6.35	2.5x2	3130	9410	55	101	97	18	75	39	37	44	11	M6x1P	49	FSVW3210F-5.0P
36	10	6.35	1.5x2	2170	6480	60	82	105	18	80	42	40	49	11	M6x1P	30	FSVW3610F-3.0P
40	5	3.175	3.5x1	1350	4160	58	55	92	16	72	42	34	46	9	M8x1P	43	FSVW4005B-3.5P
50	10	6.35	3.5x1	2590	8400	65	82	106	18	85	44	42	52	11	PT1/8"	45	FSVW4010F-3.5P
	10	6.35	3.5x2	4940	21000	80	125	138	22	110	52	48	62	18	M6x1P	98	FSVW5010F-7.0P
63	10	6.35	2.5x2	4770	18660	108	105	154	22	130	44	53	76	14	M8x1P	75	FSVW6310F-5.0P
80	10	6.35	2.5x2	5340	23750	130	105	176	22	152	48	64	91	14	M8x1P	90	FSVW8010F-5.0P

Note: Stiffness of nut: Stiffness values listed above are derived from theoretical formula to the elastic deformation between thread grooves and balls while axial load is 30% dynamic load rating.

RSVW

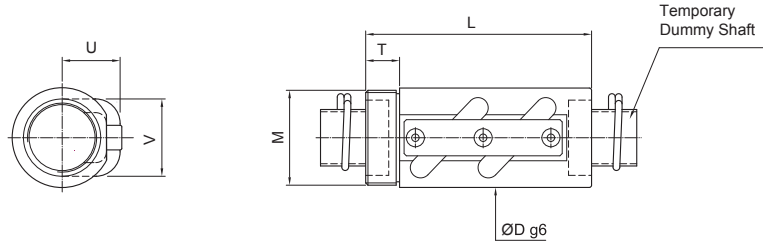

Unit: mm

SCREW SIZE		BALL DIA.	EFFECTIVE TURNS circuit × row	BASIC RATE LOAD (kgf)		BALLNUT DIMENSION								
O.D.	LEAD			Dynamic (1×10 ⁶ REV.) Ca	Static Co	O.D.		Length		Flange		Return tube	STIFFNESS kgf/μm	Nut Model NO.
						D	L	M	T	U	V			
14	4	2.381	3.5×1	500	1100	25	42	M24×1.0P	10	19	21	15	RSVW1404A-3.5P	
	5	3.175	2.5×1	515	990	30	43	M26×1.5P	10	19	21	11	RSVW1405B-2.5P	
20	5	3.175	2.5×1	625	1450	40	43	M36×1.5P	12	23	27	15	RSVW2005B-2.5P	
25	5	3.175	2.5×1	720	1830	42	48	M40×1.5P	15	28	32	18	RSVW2505B-2.5P	
			2.5×2	1120	3710	63			37	RSVW2505B-5.0P				
25	10	6.350	2.5×1	1720	3590	44	68	M42×1.5P	15	34	37	21	RSVW2510F-2.5P	
			2.5×2	3200	7170	98			40	RSVW2510F-5.0P				
32	10	6.350	2.5×1	1930	4680	55	72	M50×1.5P	18	37	44	25	RSVW3210F-2.5P	
			2.5×2	3130	9410	101			49	RSVW3210F-5.0P				
40	10	6.350	3.5×2	4450	16800	65	128	M60×2.0P	25	44	52	81	RSVW4010F-7.0P	
50	10	6.350	3.5×2	4940	21000	80	143	M75×2.0P	40	48	62	98	RSVW5010F-7.0P	

Note: Stiffness of nut: Stiffness values listed above are derived from theoretical formula to the elastic deformation between thread grooves and balls while axial load is 30% dynamic load rating.

FSBW

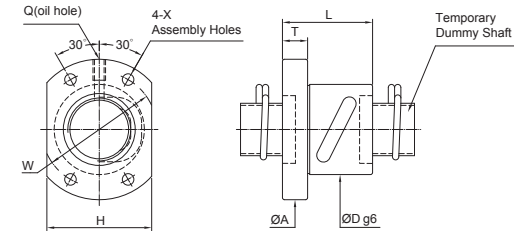

Unit: mm

SCREW SIZE		BALL DIA.	EFFECTIVE TURNS circuit × row	BASIC RATE LOAD (kgf)		BALLNUT DIMENSION											
O.D.	LEAD			Dynamic (1×10 ⁶ REV.) Ca	Static Co	O.D.		Length			Flange			Assembly Hole	Oil Hole	STIFFNESS kgf/μm	Nut Model NO.
						D	L	A	T	W	H	X	Q				
12	5	2.000	2.5×1	270	350	26	40	47	10	37	30	4.5	M6×1P	8.2	FSBW1205Z-2.5P		
						31	40	50	10	40	37	4.5	M6×1P	15	FSBW1404A-3.5P		
14	4	2.381	3.5×1	500	1100	32	40	50	10	40	38	4.5	M6×1P	11	FSBW1405B-2.5P		
						34	40	54	10	44	40	4.5	M6×1P	13	FSBW1605B-2.5P		
16	5	3.175	2.5×1	570	1130	40	41	59	10	50	46	4.5	M6×1P	14	FSBW2004A-2.5P		
						40	40	59	10	50	46	4.5	M6×1P	16	FSBW2005B-2.5P		
20	4	2.381	2.5×1	415	850	43	41	67	10	55	50	4.5	M6×1P	17	FSBW2504A-2.5P		
						43	40	67	10	55	50	5.5	M6×1P	18	FSBW2505B-2.5P		

Note: Stiffness of nut: Stiffness values listed above are derived from theoretical formula to the elastic deformation between thread grooves and balls while axial load is 30% dynamic load rating.

SSVW

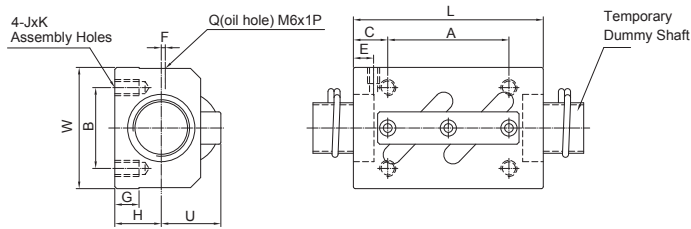

Unit:mm

SCREW SIZE		BALL DIA.	EFFECTIVE TURNS circuit × row	BASIC RATE LOAD (kgf)		BALLNUT DIMENSION											Nut Model NO.	
O.D.	LEAD			Dynamic (1×10 ⁶ REV.) Ca	Static Co	Length	Width	Height	Assembly Hole				Position of Oil Hole		Height from Reference Surface	STIFFNESS kgf/μm		
									A	B	C	J×K	E	F				G
14	4	2.381	3.5×1	500	1110	35	34	13	22	26	6.5	M4×7	6	2	6	18	15	SSVW1404A-3.5P
	5	3.175	2.5×1	515	990	35	34	13	22	26	6.5	M4×7	6	2	6	18	11	SSVW1405B-2.5P
16	5	3.175	2.5×1	590	1210	35	42	16	22	32	6.5	M5×8	6	2	8	21	13	SSVW1605B-2.5P
	5	3.175	2.5×1	625	1450	35	48	17	22	35	6.5	M6×10	6	3	9.15	22	15	SSVW2005B-2.5P
20	10	4.762	2.5×1	1100	2220	58	48	18	35	35	11.5	M6×10	10	2	9.5	25	16	SSVW2010D-2.5P
	5	3.175	2.5×1	720	1830	35	60	20	22	40	6.5	M8×12	7	5	9.5	25	18	SSVW2505B-2.5P
25	10	6.350	2.5×2	3240	7170	94	60	23	60	40	17	M8×12	10	-	10	30	40	SSVW2510F-5.0P
	6	3.175	2.5×2	1380	4140	67	60	22	40	40	13.5	M8×12	8	5	10	27	39	SSVW2806B-5.0P
32	10	6.350	2.5×1	1930	4680	64	70	26	45	9.5	M8×12	10	-	12	36		25	SSVW3210F-2.5P
			2.5×2	3130	9410	94			60	17							49	SSVW3210F-5.0P

Note: Stiffness of nut: Stiffness values listed above are derived from theoretical formula to the elastic deformation between thread grooves and balls while axial load is 30% dynamic load rating.

End Cap Series

FSKW

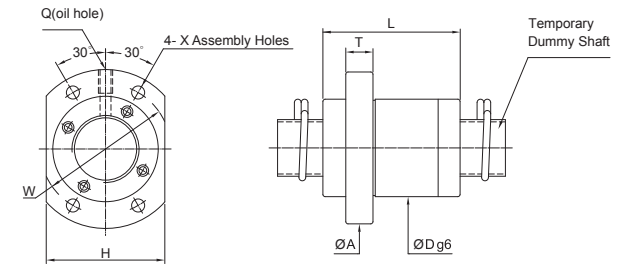

Unit:mm

SCREW SIZE		BALL DIA.	EFFECTIVE TURNS circuit × number of thread	BASIC RATE LOAD (kgf)		BALLNUT DIMENSION											Nut Model NO.
O.D.	LEAD			Dynamic (1×10 ⁶ REV.) Ca	Static Co	O.D.	Length		Flange			Assembly Hole		Oil Hole	STIFFNESS kgf/μm		
							D	L	A	T	W	H	X			Q	
12	12	2.381	1.8×2	410	850	25	31	40	6	32	21	4.5	M4×0.7P	13	FSKW1212A-3.6P		
	10	3.175	2.8×2	1000	2570	34	44	57	10	45	40	5.5	M6×1P	26	FSKW1510B-5.6P		
15	20	3.175	1.8×1	380	830	34	45	57	10	45	40	5.5	M6×1P	26	FSKW1520B-1.8P		
	16	3.175	1.8×1	330	640	32	38	53	10	42	38	4.5	M6×1P	9	FSKW1616B-1.8P		
16	20	3.175	1.8×2	780	2280	39	52	62	10	50	46	5.5	M6×1P	21	FSKW2020B-3.6P		
	40	3.175	0.8×2	390	1010	38	41	58	10	48	40	5.5	M6×1P	14	FSKW2040B-1.6P		
20	40	3.175	1.8×1	430	1140	38	81	58	10	48	40	5.5	M6×1P	16	FSKW2040B-1.8P		
			1.8×2	1230	3570									47	62	74	12
25	25	3.969	1.8×4	2230	7140	47	62	74	12	60	56	6.6	M6×1P	52	FSKW2525C-7.2P		
			1.8×2	1760	5500									58	78	92	15
32	32	4.762	1.8×4	3200	11000	58	78	92	15	74	68	9	M6×1P	65	FSKW3232D-7.2P		
			1.8×2	2870	9170									73	95	114	17
40	40	6.350	1.8×4	5220	18340	73	95	114	17	93	84	11	M6×1P	81	FSKW4040F-7.2P		
			1.8×2	7890	26330									90	122	135	20

Note: Stiffness of nut: Stiffness values listed above are derived from theoretical formula to the elastic deformation between thread grooves and balls while axial load is 30% dynamic load rating.

PMI Rolled BallScrews

Internal Ball Circulation Series

FSIW

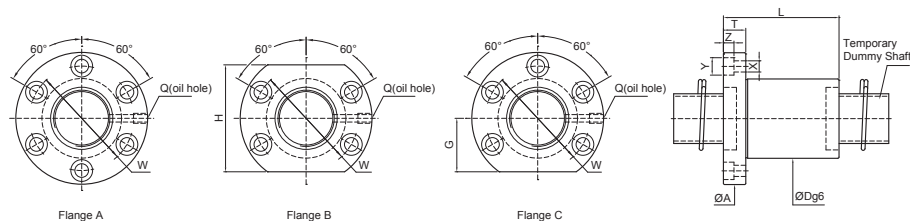

Unit:mm

SCREW SIZE		BALL DIA.	EFFECTIVE TURNS	BASIC RATE LOAD (kgf)		BALLNUT DIMENSION													Nut Model NO.	
O.D.	LEAD			Dynamic (1x10 ⁶ REV) Ca	Static Co	O.D.			Length			Flange			Assembly Hole			Oil Hole		STIFFNESS kgf/mm
						D	L	A	T	W	G	H	X	Y	Z	Q				
14	4	2.381	4	400	890	26	47	46	10	36	20	40	4.5	8	4.5	M6x1P	18	FSIW1404A-4.0P		
16	4	2.381	3	320	760	28	42	48.5	10	39	20	40	4.5	8	4.5	M6x1P	13	FSIW1604A-3.0P		
	5	3.175	3	570	1030	30	42	49	10	39	20	40	4.5	8	4.5	M6x1P	17	FSIW1605B-3.0P		
20	4	2.381	4	450	1270	34	44	60	12	48	22	44	5.5	9.5	5.5	M6x1P	19	FSIW2004A-4.0P		
	5	3.175	4	830	1890	34	53	57	12	45	20	40	5.5	9.5	5.5	M6x1P	21	FSIW2005B-4.0P		
25	4	2.381	3	380	1195	40	40	63	12	51	22	44	5.5	9.5	5.5	M8x1P	17	FSIW2504A-3.0P		
	5	3.175	4	940	2420	40	53	63.5	12	51	22	44	5.5	9.5	5.5	M8x1P	26	FSIW2505B-4.0P		
	10	4.762	4	1550	3540	42	85	68.5	15	55	26	52	6.6	11	6.5	M8x1P	28	FSIW2510D-4.0P		
28	6	3.175	3	770	2180	43	50	68	12	55	26	52	6.6	11	6.5	M8x1P	22	FSIW2806B-3.0P		
	5	3.175	4	1050	3390	48	53	73.5	12	60	30	60	6.6	11	6.5	M8x1P	32	FSIW3205B-4.0P		
32	10	6.35	4	2510	5880	54	90	88	16	70	34	68	9	14	8.5	M8x1P	34	FSIW3210F-4.0P		
	36	10	6.35	4	2570	6870	58	89	98	18	77	36	72	11	17.5	11	M8x1P	39	FSIW3610F-4.0P	
40	5	3.175	4	1180	4390	55	56	88.5	16	72	29	58	9	14	8.5	M8x1P	38	FSIW4005B-4.0P		
	10	6.35	4	2630	7860	64	93	106	18	84	43	86	11	17.5	11	M8x1P	41	FSIW4010F-4.0P		
50	10	6.35	4	2770	10290	74	93	116	18	94	42	84	11	17.5	11	M8x1P	50	FSIW5010F-4.0P		
63	10	6.35	4	3760	13700	85	98	132	22	107	48	96	14	20	13	M8x1P	60	FSIW6310F-4.0P		
80	10	6.35	4	4130	17660	105	98	151	22	127	57	114	14	20	13	M8x1P	73	FSIW8010F-4.0P		

Note: Stiffness of nut: Stiffness values listed above are derived from theoretical formula to the elastic deformation between thread grooves and balls while axial load is 30% dynamic load rating.

FSDW

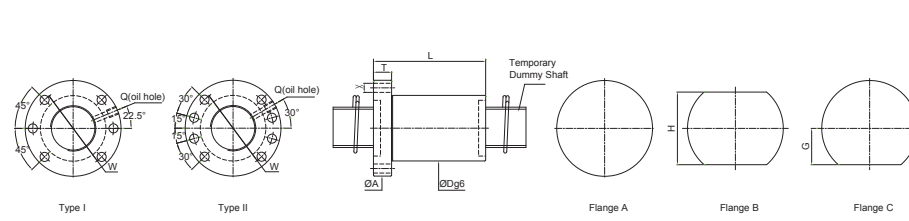

Unit:mm

SCREW SIZE		BALL DIA.	EFFECTIVE TURNS	MODIFIED LOAD CAPACITY (kgf)	BALLNUT DIMENSION													Nut Model NO.	
O.D.	LEAD				Dynamic (1x10 ⁶ REV) Cam	Static Coam	O.D.			Length			Flange			Oil Hole	Assembly Hole		STIFFNESS kgf/mm
							D	L	A	T	W	G	H	TYPE	Q				
12	4	2.381	3x1	410	990	24	28	44	10	34	16	32	I	M6x1P	4.5	13	FSDW1204A-3.0P		
14	4	2.381	3x1	460	1210	26	28	46	10	36	17	34	I	M6x1P	4.5	14	FSDW1404A-3.0P		
	4	2.381	4x1	590	1610	32	32	46	10	36	17	34	I	M6x1P	4.5	18	FSDW1404A-4.0P		
15	5	3.175	3x1	550	1260	29	32	51	10	39	18.5	37	I	M6x1P	5.5	14	FSDW1405B-3.0P		
	10	3.175	3x1	560	1340	29	47	51	10	39	19	38	I	M6x1P	5.5	15	FSDW1510B-3.0P		
20	3.175	2x1	370	900	29	58	51	10	39	19	38	I	M6x1P	5.5	10	FSDW1520B-2.0P			
	5	3.175	3x1	600	1460	29	35	51	10	39	19	38	I	M6x1P	5.5	16	FSDW1605B-3.0P		
16	10	3.175	3x1	580	1440	29	50	51	10	39	19	38	I	M6x1P	5.5	15	FSDW1610B-3.0P		
	16	3.175	2x1	400	950	29	51	51	10	39	19	38	I	M6x1P	5.5	11	FSDW1616B-2.0P		
	4	2.381	3x1	520	1660	32	28	54	12	42	19	38	I	M6x1P	5.5	18	FSDW2004A-3.0P		
20	5	3.175	3x1	670	1860	36	35	62	12	49	24	48	I	M6x1P	6.6	19	FSDW2005B-3.0P		
	10	4.762	3x1	1320	3390	40	52	62	12	51	24	48	I	M6x1P	6.6	21	FSDW2010D-3.0P		
	20	3.175	2x1	450	1200	36	56	62	12	49	24	48	I	M6x1P	6.6	13	FSDW2020B-2.0P		
40	3.175	1x2	370	1040	36	56	62	12	49	24	48	I	M6x1P	6.6	11	FSDW2040B-1.6P			
	4	2.381	3x1	580	2120	37	28	62	12	49	22	44	I	M6x1P	6.6	21	FSDW2504A-3.0P		
25	5	3.175	3x1	740	2350	40	36	62	12	51	24	48	I	M6x1P	6.6	21	FSDW2505B-3.0P		
	10	4.762	4x1	1920	5700	45	63	65	15	54	25.5	51	I	M6x1P	6.6	32	FSDW2510D-4.0P		
25	6.35	5x1	3380	9550	51	78	84	16	67	32	64	I	M6x1P	9	42	FSDW2510F-5.0P			
	25	3.969	2x1	780	2260	43	71	64	12	51	24	48	I	M6x1P	6.6	16	FSDW2525C-2.0P		
28	5	3.175	5x1	1240	4530	43	48	65	12	51	24	48	I	M8x1P	6.6	38	FSDW2805B-5.0P		
	5	3.175	4x1	1080	4130	50	41	87	16	72	34.5	69	I	M8x1P	9	34	FSDW3205B-4.0P		
32	10	6.35	5x1	3820	12030	57	78	87	16	72	34.5	69	I	M8x1P	9	50	FSDW3210F-5.0P		
	32	4.762	2x1	1100	3420	53	90	87	16	72	34.5	69	I	M8x1P	9	20	FSDW3232D-2.0P		

Note: Stiffness of nut: Stiffness values listed above are derived from theoretical formula to the elastic deformation between thread grooves and balls while axial load is 30% dynamic load rating.

FSDW

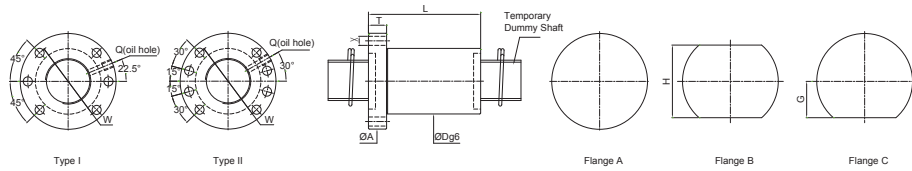

Unit: mm

SCREW SIZE		BALL DIA.	EFFECTIVE TURNS circuit × number of thread	MODIFIED LOAD CAPACITY (kgf)		BALLNUT DIMENSION												
O.D.	LEAD			Dynamic (1×10 ³ REV.) Cam	Static Coam	O.D.	Length	Flange						Oil Hole	Assembly Hole	STIFFNESS	Nut Model NO.	
					D	L	A	T	W	G	H	TYPE	Q	X	kgf/m			
36	10	6.35	3×1	2570	61	58										52	FSDW3610F-3.0P	
			5×1	4080	61	78	91	18	76	34	68	II	M6x1P	9	55	FSDW3610F-5.0P		
40	5	3.175	4×1	1180	60	42	91	18	76	34	68	II	M8x1P	9	40	FSDW4005B-4.0P		
			5×1	4290	65	78	95	18	80	36	72	II	M8x1P	9	59	FSDW4010F-5.0P		
	20	6.35	4×1	3480	65	110	98	18	83	37	74	II	M8x1P	11	48	FSDW4020F-4.0P		
			2×1	1810	65	110	98	18	83	37	74	II	M8x1P	11	25	FSDW4040F-2.0P		
50	10	6.35	5×1	4780	75	78	118	18	100	46	92	II	M8x1P	11	70	FSDW5010F-5.0P		
			5×1	5230	88	84									84	FSDW6310F-5.0P		
63	20	6.35	5×1	5320	88	130	135	22	115	50	110	II	M8x1P	14	137	FSDW6320F-5.0P		
			5×1	24930	88	130	135	22	115	50	110	II	M8x1P	14	101	FSDW8010F-5.0P		
80	10	6.35	5×1	5840	106	80	165	25	145	65	130	II	M8x1P	14	101	FSDW8010F-5.0P		

Note: Stiffness of nut: Stiffness values listed above are derived from theoretical formula to the elastic deformation between thread grooves and balls while axial load is 30% dynamic load rating.

PMI Rolled BallScrews
Miniature Series

FSMW

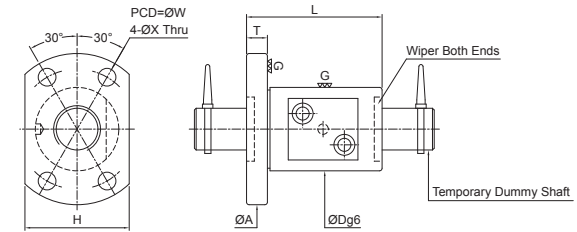

Unit: mm

SCREW SIZE		BALL DIA.	EFFECTIVE TURNS circuit × row	BASIC RATE LOAD (kgf)		BALLNUT DIMENSION									
O.D.	LEAD			Dynamic (1×10 ³ REV.) Ca	Static Co	O.D.	Length	Flange				Assembly Hole	Nut Model NO.		
						D	L	A	T	W	H	X			
8	1	0.8	2.5×1	66	140	14	16	27	4	21	18	3.4	FSMW00801X-2.5P		
	2	1.2	2.5×1	100	190	16	26	29	4	23	20	3.4	FSMW00802Y-2.5P		
10	2.5	2	2.5×1	260	370	18	26	29	4	25	20	3.4	FSMW00812Z-2.5P		
	2	1.588	2.5×1	220	370	18	28	35	5	27	22	4.5	FSMW01002K-2.5P		

Note: Stiffness of nut: Stiffness values listed above are derived from theoretical formula to the elastic deformation between thread grooves and balls while axial load is 30% dynamic load rating.

Automation Industry Specialized Type

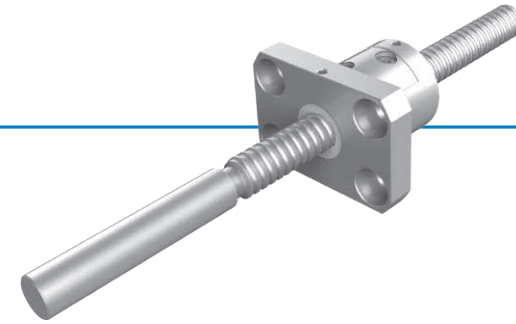

Product Features

High Applicability Shaft Ends

Without heat treating processes on the shaft ends, the center holes on both side will be reserve. The shaft ends could be easily manufactured to favored size.

Short Delivery

Standardized stock for general specification's thread length and length of blank shaft ends.

Lower Price

The accuracy can be as good as JIS C5 and C7 grade and with standardized axial clearance for the reason that can be cost down and the price will be cheaper.

Nomenclature

PTR 20 10 T3 C7 S -1500

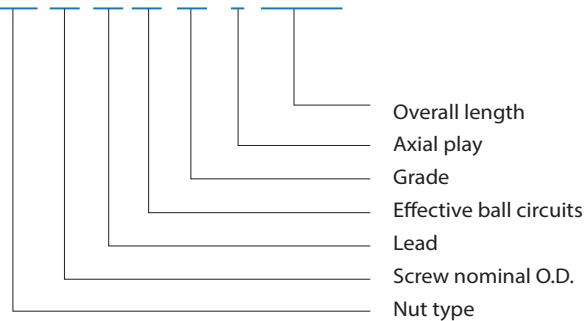

- Nut type PPR: FSMM(Miniature Series)
PTR: FSDM (End Deflector Series)
- Effective ball circuits PPR (Miniature Series)
A1: 1.5×1 circuits / B1: 2.5×1 circuits
PTR (End Deflector Series)
T2: 2 circuits / T3: 3 circuits

Unit: mm

Grade	Axial play	Z	T	S	N
	0 (Preload)	0.005 or less	0.010 or less	0.030 or less	
C5	C5Z	C5T	-	-	
C7	-	-	C7S	C7N	

PPR(Miniature Series) - Features

Space Saving

External circulation system, it don't need to have at least one end with complete thread to the end of Ballscrew for Ballnut assembly to screw shaft. And the special design of ballnut, so the size of ballnut is same as internal circulation system of ballnut, Space saving.

Circulation

By way of 3D Spline designed pathway for circulation system, and has enhanced the smooth circulation of ball ,that can reduce the wearing and increase the life of ballscrew.

PTR(End Deflector Series) - Features

Space Saving

The ballnut diameter reduces 20%~25% substantially and the length of nut is shorter.

Low Noise

The average and accurate ball circle diameter (BCD) through whole threads make the ballscrews to obtain the stable and consistent drag torque as well as to reduce the noise. The audio frequency is low and deep due to the designed of plastic circulation system.

PTR

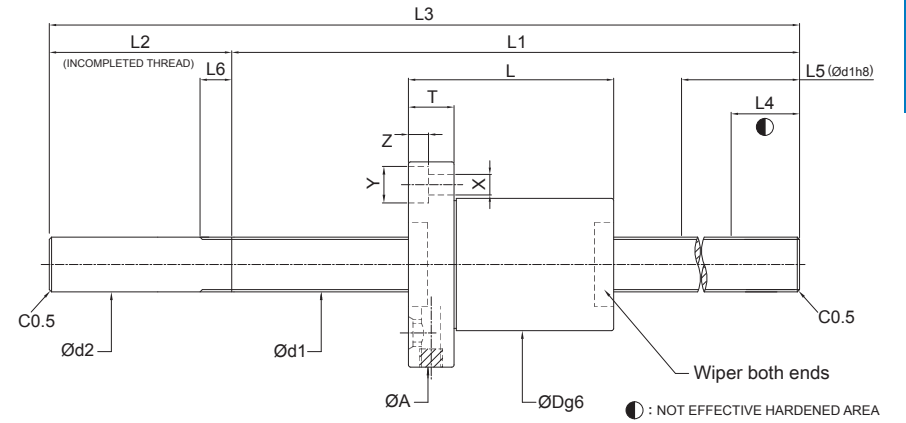
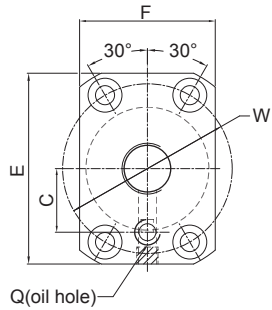
 End deflector nut series

● : NOT EFFECTIVE HARDENED AREA

Unit:mm

Model No.	SCREW SIZE		EFFECTIVE TURNS	MODIFIED LOAD CAPACITY(kgf)		SCREW SHAFT LENGTH				SCREW SHAFT LENGTH				NUT		FLANGE					OIL HOLE		BOLT		
	O.D d1	LEAD		Dynamic (1×10 ⁶ REV.) Cam	Static Coam	L1	L2	L3	L4	L5	L6	d2	Dg6	L	A	T	W	E	F	C	Q	X	Y	Z	
PTR1205T3C5T-0300	12	5	3	610	1190	240	60	300	10	150	7	12	30	32	50	10	40	45	32	15	M6	4.5	8	4.4	
PTR1205T3C5T-0450						390		450	15																
PTR1210T3C5T-0300	12	10	3	590	1160	240	60	300	10	150	7	12	30	45	50	10	40	45	32	15	M6	4.5	8	4.4	
PTR1210T3C5T-0450						390		450	15																
PTR1220T2C5T-0450	12	20	2	390	770	390	60	450	15	150	7	12	30	54	50	12	40	45	32	15	M6	4.5	8	4.4	
PTR1220T2C5T-0600						540		600	15																
PTR1505T3C5T-0300	15	5	3	850	1640	240	60	300	10	150	7	15	34	35	55	11	45	50	34	18	M6	5.5	9.5	5.4	
PTR1505T3C5T-0450						390		450	10																
PTR1505T3C5T-0600						540		600	10																
PTR1505T3C5T-0750						690		750	15																
PTR1505T3C5T-0900						840		900	15																
PTR1510T3C5T-0300	15	10	3	840	1610	240	60	300	10	150	7	15	34	47	55	11	45	50	34	18	M6	5.5	9.5	5.4	
PTR1510T3C5T-0450						390		450	10																
PTR1510T3C5T-0600						540		600	10																
PTR1510T3C5T-0750						690		750	15																
PTR1510T3C5T-0900						840		900	15																
PTR1510T3C5T-1100	1040	1100	15																						
PTR1520T2C5T-0450	15	20	2	560	1050	390	60	450	15	150	7	15	34	58	55	11	45	50	34	18	M6	5.5	9.5	5.4	
PTR1520T2C5T-0600						540		600	15																
PTR1520T2C5T-0750						690		750	15																
PTR1520T2C5T-0900						840		900	15																
PTR1520T2C5T-1000						940		1000	15																
PTR1520T2C5T-1100						1040		1100	15																
PTR1520T2C5T-1300						1240		1300	15																
PTR2005T3C5T-0400						20		5	3																1000
PTR2005T3C5T-0600	520	600	15																						
PTR2005T3C5T-0800	720	800	15																						
PTR2005T3C5T-1000	920	1000	15																						
PTR2010T3C5T-0600	20	10	3	1530	3280	515	85	600	15	200	8	20	46	52	74	13	59	66	46	24	M6	6.6	11	6.5	
PTR2010T3C5T-0800						715		800	15																
PTR2010T3C5T-1000						915		1000	15																
PTR2010T3C5T-1300						1215		1300	15																
PTR2010T3C5T-1500						1415		1500	15																

PTR C7

End deflector nut series

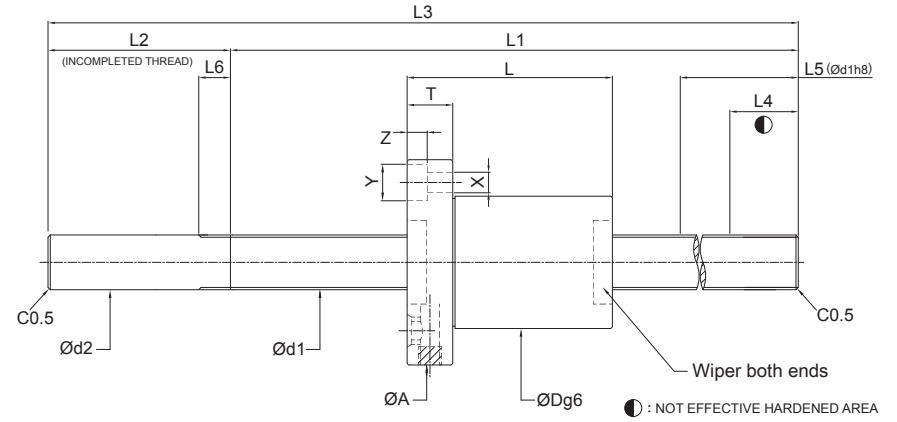
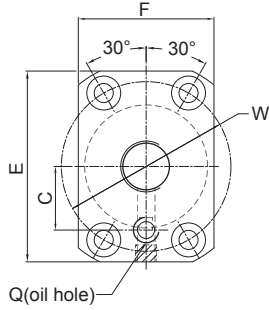

Model No.	SCREW SIZE		EFFECTIVE TURNS	MODIFIED LOAD CAPACITY(kgf)		SCREW SHAFT LENGTH				SCREW SHAFT LENGTH			NUT		FLANGE				OIL HOLE		BOLT								
	O.D d1	LEAD		Dynamic (1×10 ⁶ REV.) Cam	Static Coam	L1	L2	L3	L4	L5	L6	d2	Dg6	L	A	T	W	E	F	C	Q	X	Y	Z					
PTR1205T3C7S-0300	12	5	3	610	1190	240	60	300	15																				
PTR1205T3C7S-0450						390		450						180	7	12	30	32	50	10	40	45	32	15	M6	4.5	8	4.4	
PTR1210T3C7S-0600	12	10	3	590	1160	540	60	600	15					180	7	12	30	45	50	10	40	45	32	15	M6	4.5	8	4.4	
PTR1220T2C7S-0600	12	20	2	390	770	540	60	600	15					180	7	12	30	54	50	12	40	45	32	15	M6	4.5	8	4.4	
PTR1505T3C7S-0600	15	5	3	850	1640	540	60	600	15					230	7	15	34	35	55	11	45	50	34	18	M6	5.5	9.5	5.4	
PTR1510T3C7S-0450						390		450																					
PTR1510T3C7S-0600						540		600																					
PTR1510T3C7S-0750						690		750																					
PTR1510T3C7S-0900	15	10	3	840	1610	840	60	900	15					230	7	15	34	47	55	10	45	50	34	18	M6	5.5	9.5	5.4	
PTR1510T3C7S-1000						940		1000																					
PTR1510T3C7S-1100						1040		1100																					
PTR1510T3C7S-1300						1240		1300																					
PTR1520T2C7S-0600						540		600																					
PTR1520T2C7S-0750						690		750																					
PTR1520T2C7S-0900						840		900																					
PTR1520T2C7S-1000	15	20	2	560	1050	940	60	1000	15					230	7	15	34	58	55	12	45	50	34	18	M6	5.5	9.5	5.4	
PTR1520T2C7S-1100						1040		1100																					
PTR1520T2C7S-1300						1240		1300																					
PTR2005T3C7S-0600	20	5	3	1000	2240	520	80	600	15					230	7	20	44	35	67	11	55	60	44	22	M6	5.5	9.5	5.4	
PTR2010T3C7S-0600						515		600																					
PTR2010T3C7S-1000	20	10	3	1530	3280	915	85	1000	15					230	8	20	46	52	74	13	59	66	46	24	M6	6.6	11	6.5	
PTR2010T3C7S-1500						1415		1500																					

Note: Coam and Cam are the modified static and dynamic load capacities,calculated according to ISO-3408-5

Service Problems Analysis of Ball Screws

Preface

In recent years, more and more ballscrews are installed in various machines to meet the requirements of higher accuracy and better performance.

Ballscrews become one of the most widely used power transmission components. In CNC machines, ballscrews help improve their positioning accuracy and elongate their service life. Ballscrews are also increasingly used to replace ACME screws in manually operated machines.

A ballscrew is normally preloaded to minimize the backlash of machine movement. Even a high precision ballscrew will not provide good accuracy and long service life if it is not installed properly.

This article discusses primary ballscrew problems and their precautions. Some measuring procedures are also discussed to help users locate the cause of an abnormal backlash.

The Cause and Precautions of Ballscrew Problems

Three major categories of ballscrew problems and their precautions are discussed as follows

Unsmooth operation

Defects from ballscrew manufacturing

- The return tube is not attached to the ball nut appropriately.
- The track surface of the ballscrew spindle or the ball nut is too rough.
- The roundness of the ball nut or the screw shaft is out of tolerance.
- The lead or the pitch circle diameter of the ball nut / the shaft is out of tolerance.

Over-travel

Over-travel can damage the return tube and cause it to collapse or even break. When this happens, the steel balls will not circulate smoothly. They may break and damage the groove on the ball nut or the screw shaft under severe circumstances. Over-travel may happen during set-up or as the result of a limit switch failure or a machine collision. To prevent further damage, an over-traveled ballscrew should be checked or repaired by the manufacturer before it goes back to service.

Misalignment

Radial load exists if the center line of the ball nut's housing and the screw shaft's bearing support

bracket are not aligned properly. The ballscrew unit may bend if this misalignment is too big. An abnormal wear may still happen even if the misalignment is not significant enough to cause a noticeable bending. The accuracy of a ballscrew unit will deteriorate rapidly if it is misaligned. The higher the preload is set in the nut, the more demanding the alignment accuracy is required in the ballscrew.

Foreign objects enter the ball path

Machined chips get in the ball track. The chips or dust generated during machining processes may be trapped in the ball track if wiper kits are not used to keep them away from the surface of the ballscrew unit. This may cause unsmooth operation, deteriorate accuracy and reduce service life.

Damaged return tube

The return tube may collapse and cause the same problems as mentioned above if it is hit heavily during installation.

The ball nut is not mounted properly on the nut housing

Eccentric load exists when the mounted ball nut is tilted or misaligned. If this is the case, the motor current may fluctuate during rotation.

Ballscrew unit is damaged during transportation

- During installation, avoid nuts separating away from screw, otherwise the balls will get out of the nut, that lead to change of the preload and damage of the circulation system and wiper.
- Due to the low friction coefficient, nuts will fall down because of its self weight during vertical deposition; this kind of damage should be avoided, once happened, it should be inspected by manufacturer preventing further damage.

Too much plays

No preload or insufficient preload

The ball nut will rotate and move downward by its self weight when a non-preloaded ballscrew is held vertically with the screw shaft constrained. A significant backlash may exist in a non-preloaded ballscrew unit. Therefore non-preload ballscrews are only used in the machinery, where operation resistance but not positioning accuracy low is the major concern.

PMI can determine the correct amount of preload based on different applications. We can also preset the amount of preload before shipment. Be sure to clearly specify the operation condition of your application when you order a ballscrew unit.

Inappropriate bearing selection and installation

- Angular ball bearings should be used in ballscrew installation. A ball bearing with high pressure angle specially designed for ballscrew installation is even a better choice. A regular deep groove ball bearing will generate a significant amount of axial play when axially loaded. It should not be used in this application.
- Two lock nuts and a spring washer should be used in the bearing installation to prevent them from getting loose in operation.
- The perpendicularity between the bearing seating face and the thread axis of the bearing locknut on the ballscrew, or the parallelism between the opposite faces of the locknut is out of tolerance causing the bearing to tilt. The thread for bearing lock nut and the seating face of a bearing in the ballscrew journal should be machined in one setting to ensure the perpendicularity. It is even better if they can be ground.
- If the bearing is not attached to the screw shaft properly, it would cause axial play under load. This problem may be caused by the bearing journal of the screw shaft being too long or the non-threaded part of the screw shaft being too short. To solve this problem used the collar.

Parallelism or flatness of the housing surface is out of tolerance

In a machine assembly, a shim bar is frequently located between the housing location surface and the machine body for adjustment purpose. The clearance of table movement may vary at different locations if the parallelism or flatness of any matching component is out of tolerance no matter they are ground or scraped.

The ball nut housing or the bearing housing is not rigid enough

The ball-nut-mounted housing or the bearing-mounted housing may deflect under components' weight or machining load if it is not rigid enough.

The ball nut housing or the bearing housing is not mounted properly

- Ball-nut-seated screws become loose due to vibration and lack of a spring washer.
- Ball-nut-seated screws are not seated firmly because the screws are too long or the thread holes on housing are too short.
- Components may become loose due to vibration or lack of locating pin(s). Solid pins instead of spring pins should be used for locating purpose.
- Not enough locking forces for fixing screw because of too short screws

The motor and the ballscrew spindle are not assembled properly

- There will be a relative rotation between the motor shaft and the ballscrew spindle if the connecting coupling is not installed firmly or the coupling itself is not rigid enough.

- Key is loose in the groove. Any inappropriate match among the hub, key, and key seat may cause these components to generate backlash.
- Driving gears are not engaged properly or driving mechanism is not rigid. A timing belt should be used to prevent slipping if the ballscrew is to be driven by a belt.

Fracture

Broken bearing ball

Cr-Mo steel is the most commonly used material for bearing balls. It takes about 1,400kg (3,080lb) to 1,600kg (3,520lb) to break a steel ball of 3.175 mm (1/8 in) diameter. The temperature of an under-lubricated or non-lubricated ballscrew raises substantially during operation. This temperature raise could make the bearing balls brittle or break which cause damage to the grooves of the ball nut or the ballscrew spindle consequently.

Therefore, lubricant replenishment should be considered during the design process. If an automatic lubricating system is not available, periodical grease replenishment should be scheduled as part of maintenance program

Collapsed or broken return tube

Over-travel of the ball nut or an impact on the return tube could cause the return tube to collapse or break. This may block the path of bearing balls and cause them to slide instead of rolling and break eventually.

Ballscrew shaft end breaks

- Inappropriate design: Sharp corners on the ballscrew spindle should be avoided to reduce local stress concentration.
- Bend of screw shaft journal: The seating surface of the bearing of the ballscrew and the thread axis of the bearing's lock nut are not perpendicular to each other or the opposite sides of the lock nut are not parallel to each other. This will cause the end of screw shaft to bend and eventually break. The amount of deflection at the end of the ballscrew shaft before and after the bearing's lock nut being tightened should not exceed 0.01 mm (0.0004 in).
- Radial force or fluctuating stress: Misalignment in the ballscrew installation creates abnormal fluctuating shear stress and causes the ballscrew to fail prematurely.
- It should be avoided, that the dimension of ball screw shaft end too much different designed from ball screw shaft section area.

Influence of temperature raise on ball screw

During the operation of ball screws, the accuracy of machine drive system will be influenced by the raise of the temperature, especially for the high speed and high accuracy machines. Following factors affect the temperature raise of ball screws.

- The Influence of Preload

Increase the rigidity of ball screw nut in order to avoid the lost motion of the machine drive system, that means increase the preload of the nut to a certain standard. Once the nut is preloaded, the friction torque will increase, making the temperature raised during operation. *PMI* recommends that the preload force should be 1/3 of the maximal axial load and is not bigger than 10% of the dynamic load, in order to obtain the optimal life time and lower temperature raise effect.

- The Influence of Pretension

The elongation and deformation of ball screws because of heat will deteriorate the position accuracy. The amount of thermal elongation can be calculated by certain formula and compensated by preloading torque. The target value of the Pretension compensation is the negative T value on the diagram. Too much Pretension will burn the support bearing. Therefore *PMI* recommends that the pretension should be smaller than the Pretension by 5°C; however when the ball screw diameter is over 50mm, it is not suitable for a preloading torque, that means large Pretension forces will be needed when the diameter is large and will burn down the support bearing. *PMI* recommends that 2~5°C of temperature raise should be used as standard to compensate the value T (about -0.02~0.06mm every 1000mm of ball screw)

- The Influence of Lubrication

The choice of the lubrication will directly affect the temperature raise of the ball screws. The ball screws of *PMI* should be lubricated by oil or grease. Normally lubrication oil for bearings will be recommended as ball screw lubrication, and grease from lithium soap will be recommended as lubrication grease. The choice of viscosity of the lubrication should be according to the operation speed, the working temperature, and the situation of load.

Low viscosity lubrication should be chosen during high speed and low load situation; high viscosity lubrication during low speed and high load situation. Normally, viscosity range of lubrication will be recommended at 32~68cSt (ISO VG 32~68)(DIN51519) during 40°C, high speed; viscosity range of lubrication will be recommended over 90cSt(ISO VG 90) during 40°C, low speed. By application of high speed and heavy load, force cooling must be used in order to reduce the temperature, and using hollow ball screw or cooling oil through nut to meet the cooling requirement.